



VIVALDI

1.1

CATALOGO RAPIDO
QUICK CATALOGUE

VIVALDI



TELEMACO & KEYSOL WiFi

pag. 5 - 33



BLUETOOTH

pag. 35 - 37



Smart Multimedia Home & Building Automation

pag. 39 - 47



Multiroom Audio Video Multimediali
Multiroom Audio Video Multimedia

pag. 49 - 59



Video

pag. 61 - 69



Public Address & Professional

pag. 71 - 99



Evacuazione vocale con gestione multimediale (APP)
Voice evacuation with multimedia management (APP)

pag. 101 - 131



Diffusori
Speakers

pag. 133 - 167
pag. 175 - 177
pag. 180 - 207



Subwoofer

pag. 169 - 173
pag. 178



Cinema

pag. 208 - 219



Telemaco

Telemaco il nuovissimo multiroom integrato da 6 zone espandibile fino a 12. Perfetto per tutte le abitazioni. Compatto, 6 moduli DIN, implementa 4 player multisorgente (YouTube, WebRadio, Spotify, NAS...) e 6 amplificatori audio per collegare diffusori 8 Ω a bassa impedenza (imp. min. 4Ω). Dotato di 3 ingressi stereo per sorgenti esterne (PC, giradischi, TV, CD, Playstation, ...) con uscite preamplificate per il collegamento di espansioni di potenza, diffusori o subwoofer attivi, l'integrazione domotica avviene con connettività KNX o tramite protocolli MQTT e REST. Abbinando 2 TELEMACO è possibile realizzare un sistema di distribuzione audio a 12 zone, con 6 player multisorgente indipendenti (YouTube, WebRadio, Spotify, NAS...) e 6 ingressi per sorgenti esterne. D'ora in poi, la musica preferita di ognuno, in qualunque stanza e in qualsiasi momento, con un semplice tocco. Telemaco, il sistema evoluto per musica, qualsiasi musica, dalle webradio del mondo ai più moderni servizi di streaming. Progettato per riprodurre audio di qualità con semplicità, grazie ad un sistema intelligente di componenti audio HiFi. Gestito da una innovativa APP, facile da utilizzare, gratuita, scaricabile dagli store Apple e Google, oppure da PC tramite software scaricabile dal nostro sito.

Telemaco the brand new integrated multiroom with 6 zones expandable up to 12. Perfect for all homes. Compact, 6 DIN modules, implements 4 multi-source players (YouTube, WebRadio, Spotify, NAS...) and 6 audio amplifiers to connect low impedance 8 Ω loudspeakers (imp. min. 4Ω). Equipped with 3 stereo inputs for external sources (PC, turntable, TV, CD, Playstation, ...) with preamplified outputs for connecting power expansions, loudspeakers or active subwoofers, home automation integration takes place with KNX connectivity or via MQTT protocols and REST. By combining 2 TELEMACOs it is possible to create an audio distribution system with 12 zones, with 6 independent multi-source players (YouTube, WebRadio, Spotify, NAS...) and 6 inputs for external sources. From now on, everyone's favorite music, in any room and at any time, with a simple touch. Telemaco, the advanced system for music, any music, from world web radios to the most modern streaming services. Designed to reproduce quality audio with ease, thanks to an intelligent system of HiFi audio components. Managed by an innovative APP, easy to use, free, downloadable from the Apple and Google stores, or from a PC using software downloadable from our website.

VIVALDI

APP Telemaco
Telemaco APP

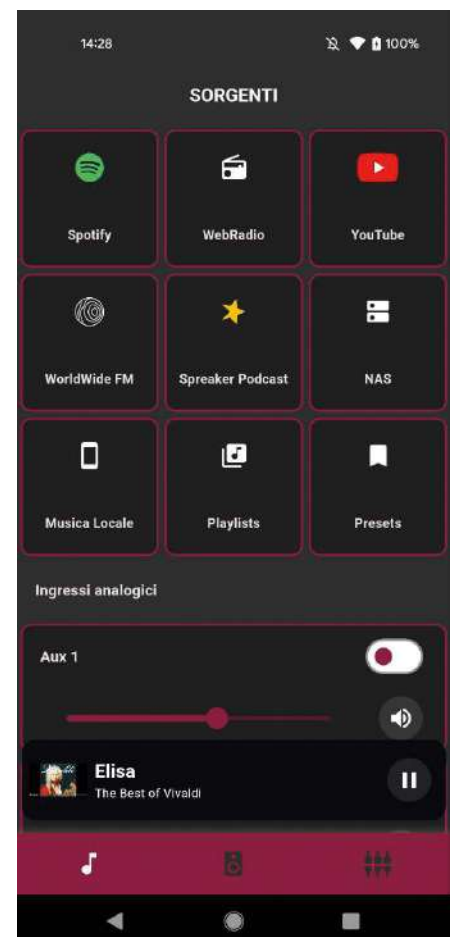
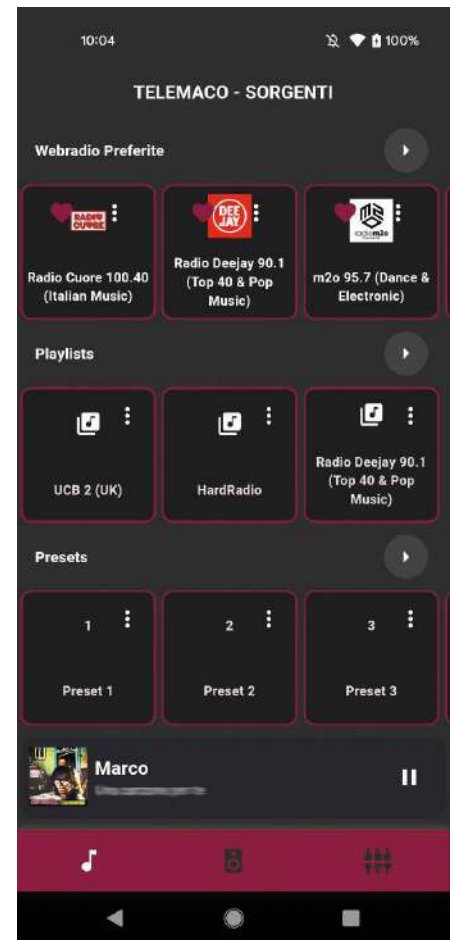
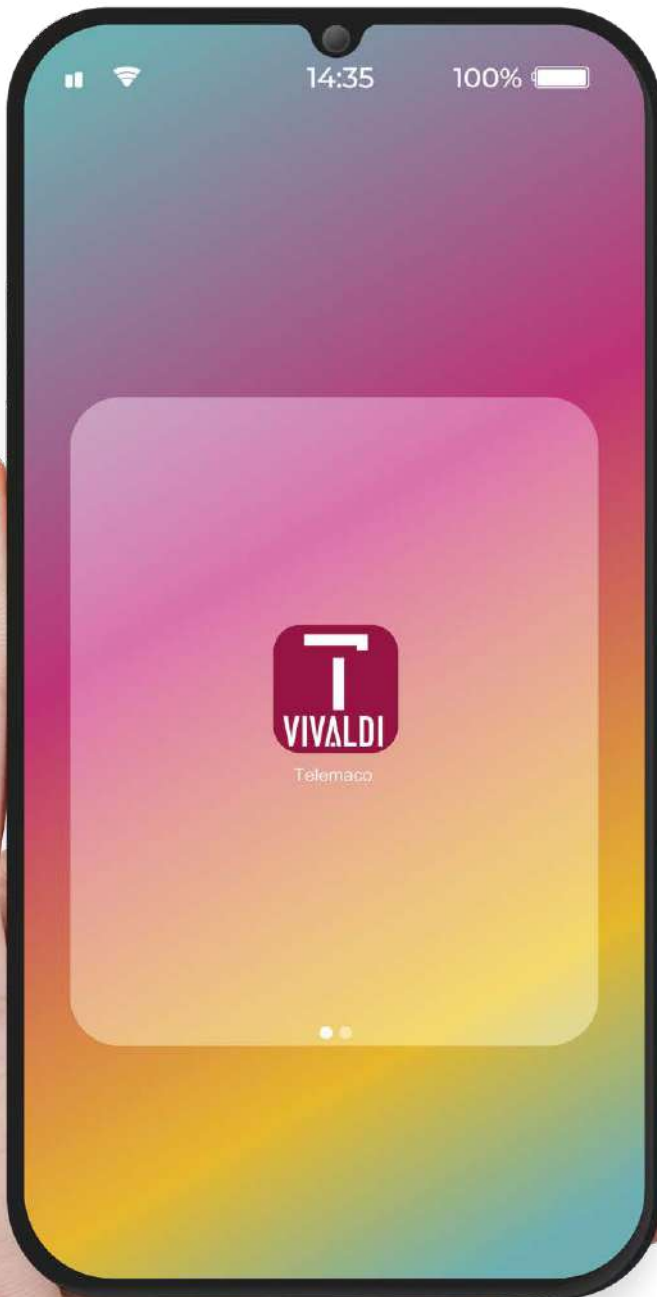

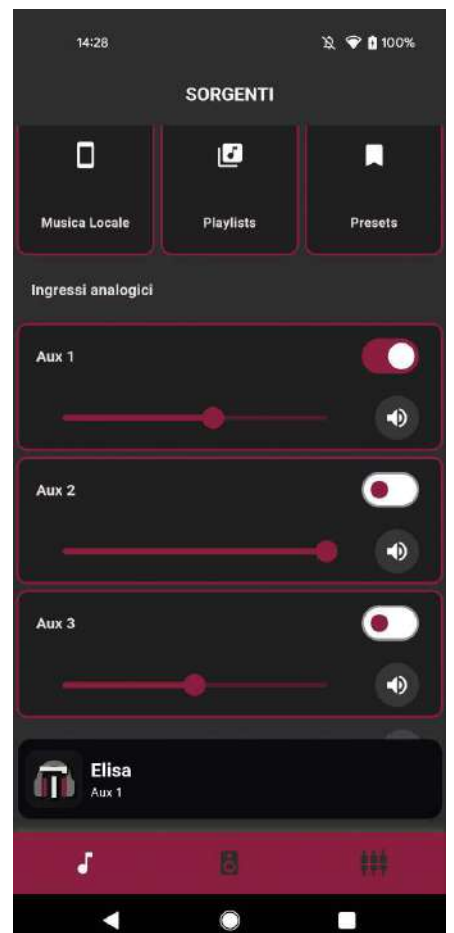
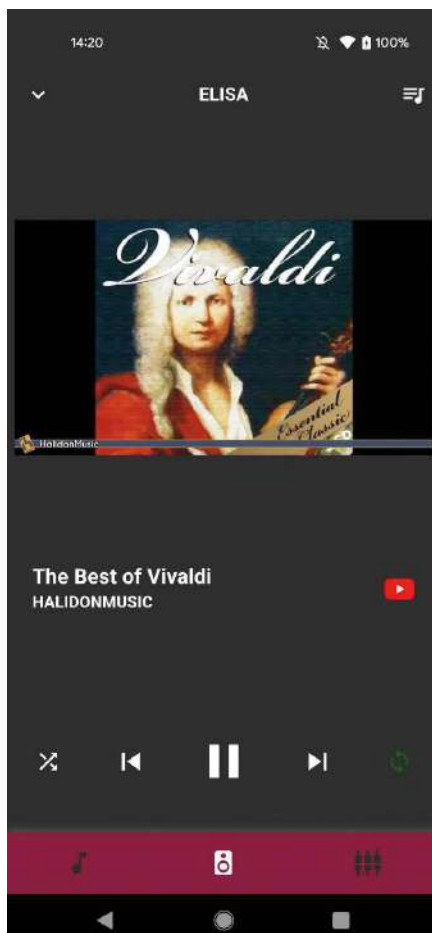
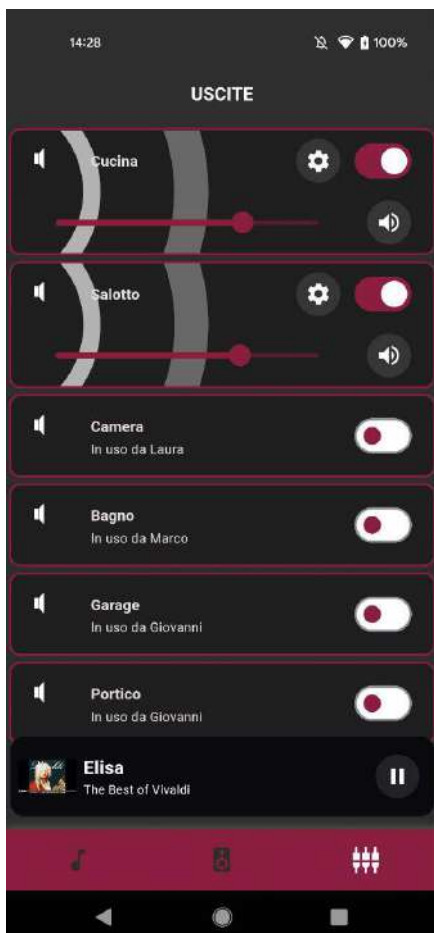
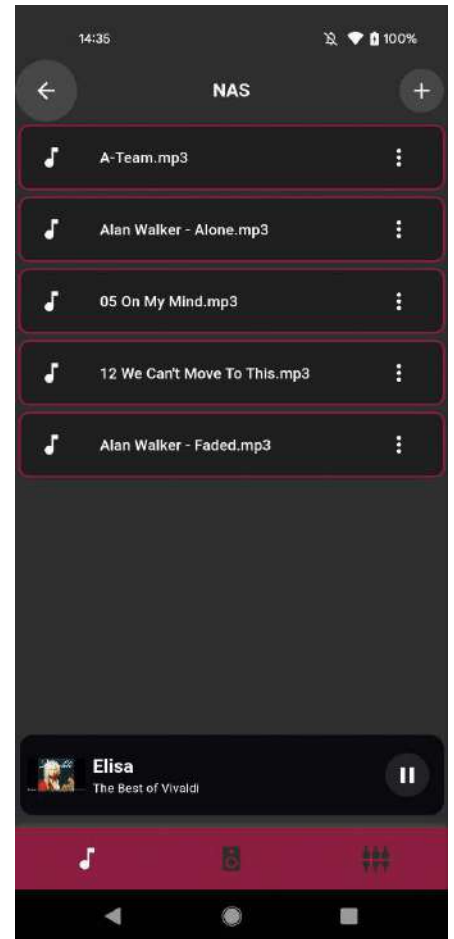
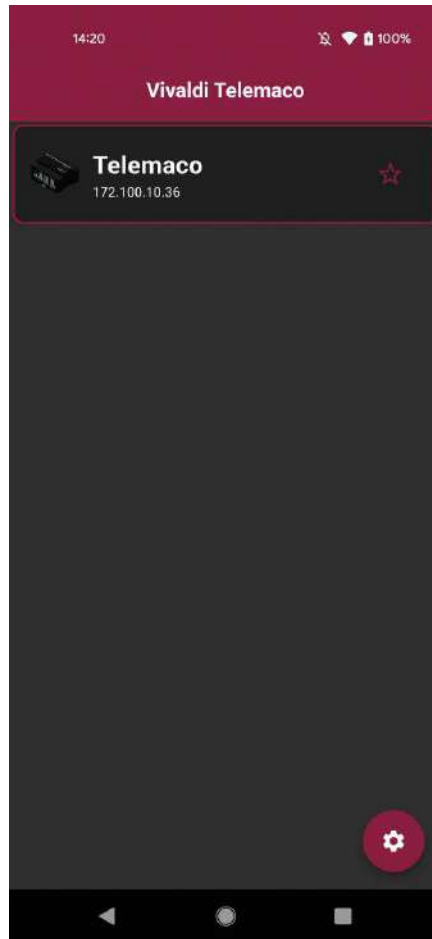
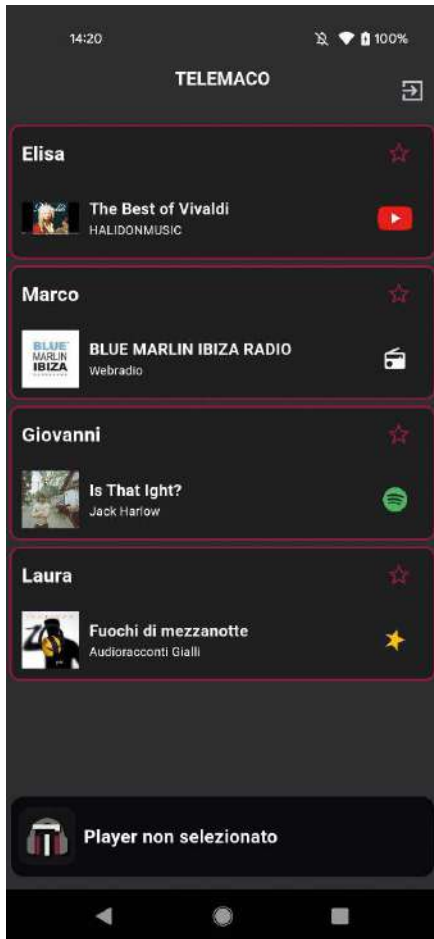



8051272189964

TELEMACO



WEB RADIO



AIRPLAY



PLAYLIST



RIPRODUZIONE
DI CONTENUTI DA NAS

HiFi

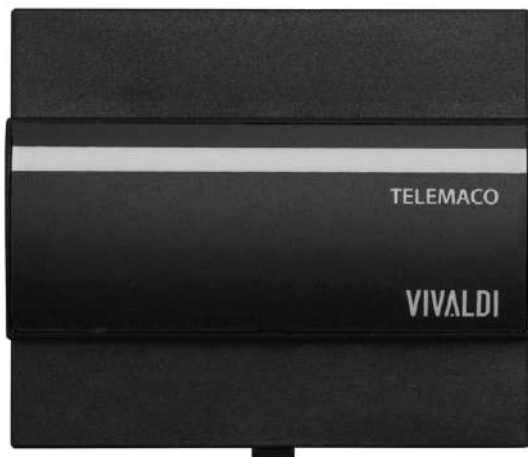

IT - Sistema multiroom all-in-one integrato, completo di amplificazione e sorgenti audio multimediali compatibile KNX, MQTT, REST.API e domotiche terze. Gestione e supervisione tramite APP Telemaco disponibile per iOS & Android. Sistema espandibile a 6 player a 12 zone, abbinando 2 Telemaco.

Ingressi:

- 3 ingressi stereo sbilanciati livello linea 0db
- Connettore alimentazione
- Micro SD

Uscite:

- 6 uscite amplificate (6x20W @ 4Ω)
- 6 uscite preamplificate bilanciate livello linea per ampliare il numero di diffusori o la potenza di zona tramite amplificatori esterni (E30S, E80S, finali Vivaldi serie PMA, finali Vivaldi serie PSA, subwoofer attivi Vivaldi, diffusori attivi Vivaldi)
- Diffusori collegabili 8Ω per ogni uscita, impedenza minima 4Ω

Connettività:

- Connettore KNX diretto
- Connettore RJ45 LAN 10/100

Player / Utenti:

- 4 Player integrati con i servizi
- Spotify Connect
- Airplay
- Webradio
- NAS
- Playlist
- Musica locale (Android)
- YouTube
- AUX

Altro:

- Creazione Playlist e accesso rapido
- Webradio preferite con accesso rapido
- Funzionalità Preset con accesso rapido
- Funzionalità Campanello con scelta per singola zona non disturbare
- Webpage di configurazione
- Personalizzazione nomi Player/Utenti, ingressi AUX e uscite zone
- Shortcut accesso al player/utente
- Impostazione zone stereo (per un massimo di 3 zone stereo o combinazione mono/stereo)
- Possibilità di accoppiare due dispositivi per la creazione di un unico sistema da 12 zone, 6 ingressi AUX, 6 player (massimo 6 zone stereo o combinazioni mono/stereo)
- App di controllo dedicata (Vivaldi Telemaco)
- API di controllo supportate: KNX, MQTT, REST

EN - Integrated all-in-one multiroom system, complete with amplification and multimedia audio sources compatible with KNX, MQTT, REST.API and home automation third. Management and supervision via Telemaco APP available for iOS & Android. System expandable to 6 players to 12 zones, combining 2 Telemaco.

Inputs:

- 3 stereo inputs unbalanced line level 0db
- Power supply connector
- Micro SD

Outputs:

- 6 amplified outputs (6x20W @ 4Ω)
- 6 line level balanced preamp outputs to expand the number of speakers or power zone via external amplifiers (E30S, E80S, Vivaldi PMA, Vivaldi PSA series power amplifiers, Vivaldi active subwoofers, Vivaldi active speakers)
- 8Ω speakers for each output, minimum impedance 4Ω

Connectivity:

- KNX connector embedded
- RJ45 LAN 10/100 connector

Player / Users:

- 4 Players integrated with services
- Spotify Connect
- YouTube
- Webradio
- Airplay
- NAS
- Local music (Android)
- Playlist
- AUX

Other:

- Playlist creation and quick access
- Favorite webradio with fast access
- Preset functionality with quick access
- Function Doorbell with choice for single zone do not disturb
- Webpage configuration
- Customizing Player/User names, AUX inputs and zone outputs
- Shortcut access to player/user
- Stereo zone setting (for up to 3 stereo zones or mono/stereo combination)
- Possibility to pair two devices to create a single 12-zones system, 6 AUX inputs, 6 players (maximum 6 stereo zones or mono/stereo combinations)
- Dedicated control app (Vivaldi Telemaco)



(con access token)

- Pulsante a sfioramento multifunzione sul frontale (reset DHCP, reset di fabbrica, IP statico...)
- Barra a LED di stato multicolore.
- Risparmio energetico amplificatori
- Aggiornamenti OTA

Opzione:

C4IO pulsanti programmabili a 4 ingressi. Tasti multifunzione a pressione breve o lunga per associare due funzioni ad ogni singolo pulsante. I primi due ingressi (pulsanti) possono essere utilizzati con encoder rotativo (TVE da ordinare a parte) per il controllo di volume.

Funzioni assegnabili ai pulsanti C4IO:

- Incremento / decremento volume
- Ingressi / uscite
- Attivazione muto e disattivazione
- Richiamo preset
- Avanti/indietro traccia player
- Stop
- Play / Pausa player
- Play USB (priorità)

Cavi da utilizzare:

- cavo di sistema MICRO2.50 per gli ingressi analogici e le uscite preout
- piastrina rosso-nera 2x0,75, o equivalente, per il collegamento degli altoparlanti e l'alimentazione
- cavo LAN cat5e/cat6
- cavo bus KNX

Dimensioni (LxHxP): 106x91x62mm, 6 moduli DIN.

Peso: 0,250 kg

Alimentazione : 24Vcc / 150W max (AL6B)

- Supported control APIs: KNX, MQTT, REST (with access token)
- Multi-function touch button on the front (DHCP reset, factory reset, static IP...)
- Multi-colored LED status bar.
- Energy saving amplifiers
- OTA updates

Option:

C4IO programmable buttons with 4 inputs. Short or long press multifunction keys to associate two functions to each single button. The first two inputs (buttons) can be used with rotary encoder (TVE to be ordered separately) for volume control.

Functions assignable to the buttons C4IO:

- Increase / decrease in volume
- Inputs / outputs
- Mute and deactivation switch
- Preset recall
- Forward/backward track player
- Stop
- Play / Pause player
- Play USB (priority)

Cables to be used:

- MICRO2.50 system cable for analog inputs and preout outputs
- Red-black cable 2x0,75 or equivalent for speaker connection and power supply
- LAN cable cat5e/cat6
- KNX bus cable

Dimensions (WxHxD): 106x91x62mm, 6 DIN modules.

Weight: 0,250 kg

Power supply : 24Vdc / 150W max (AL6B)

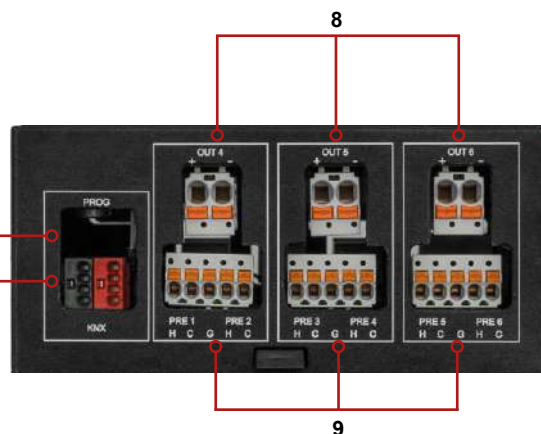
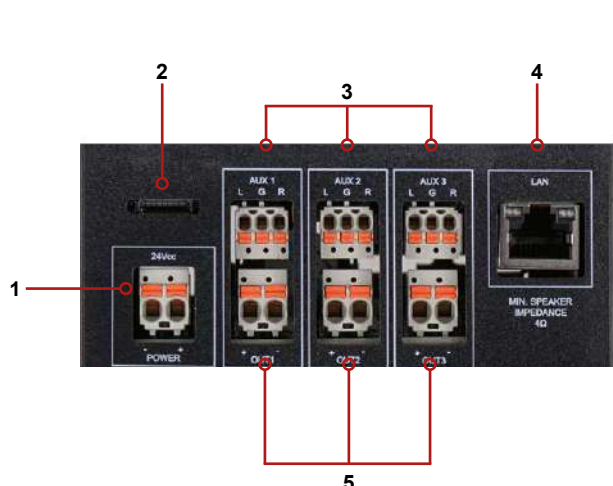

1
Ingresso alimentazione 24Vdc
24Vdc power input

2
Slot per MicroSD Card
MicroSD Card slot

3
Ingressi ausiliari stereo sbilanciati
Unbalanced stereo auxiliary inputs

4
Porta RJ45 per connessione a rete LAN
RJ45 port for LAN network connection

5
Uscite amplificate per collegamento
diffusori zone 1-2-3
Amplified outputs for connecting zone
1-2-3 loudspeakers

6
Connettore bus KNX
KNX bus connector

7
Pulsante programmazione
indirizzo fisico KNX
KNX physical address
programming button

8
Uscite amplificate per
collegamento diffusori zone 4-5-6
Amplified outputs for connecting
zone 4-5-6 loudspeakers

9
Uscite pre bilanciate per espansioni
di potenza
Pre balanced outputs for power
expansions



VIVALDI

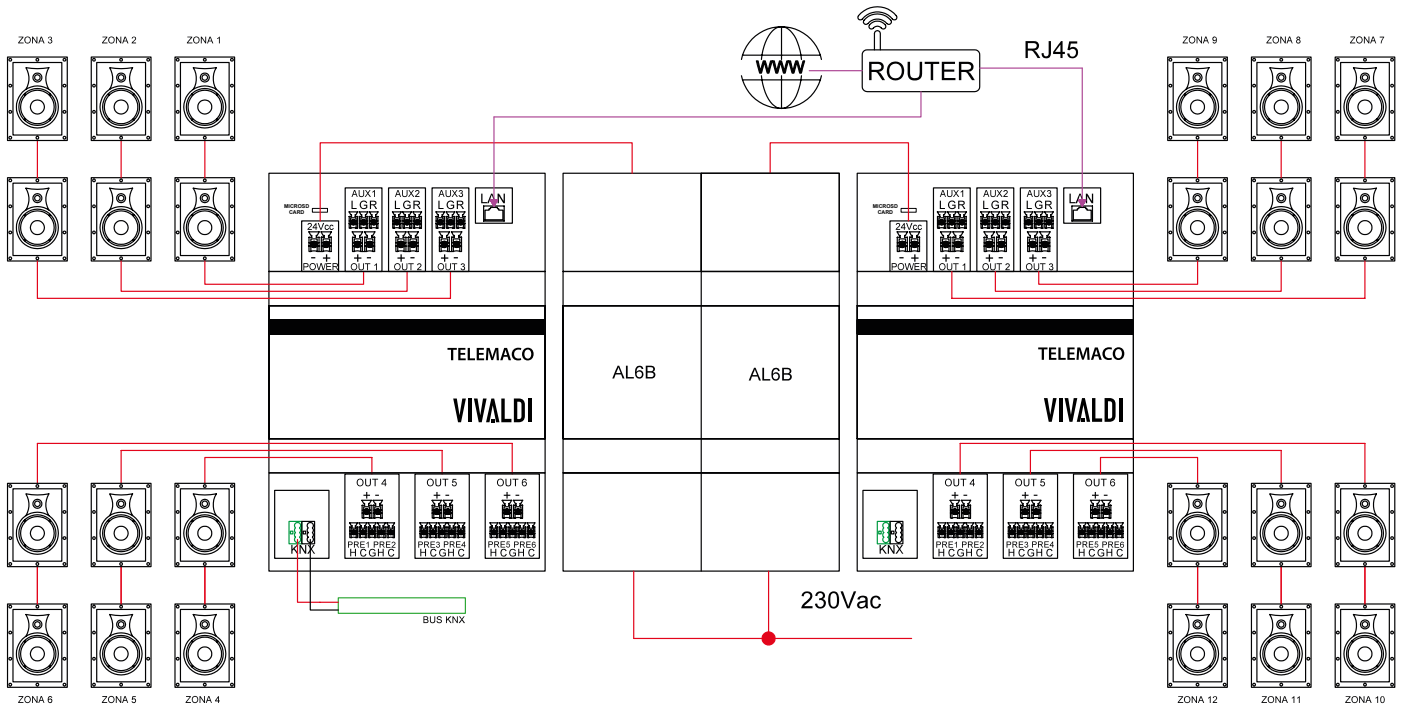



NEW 8052015550898 **C410**



IT - Interfaccia remota di comando per dispositivi P30S, P80S, MATRIX6, TELEMACO. Connettività WiFi. Webpage di configurazione.

INGRESSI

4 ingressi a pulsante con funzioni assegnabili tramite programmazione da webpage.
Pulsanti multifunzione (pressione breve e lunga) per associare due funzioni ad ogni singolo ingresso. I primi due ingressi possono essere utilizzati con encoder rotativo (accessorio TVE) per il controllo di volume tramite manopola.

Funzioni in abbinamento a P30S, P80S:

Incremento / decremento volume ingressi / uscite
Attivazione muto e disattivazione
Richiamo preset
Avanti/indietro traccia player
Stop
Play / Pausa player
Controllo volume separato canale sinistro e destro
Play USB (priorità)

Funzioni in abbinamento a MATRIX6:

Incremento / decremento volume ingressi / uscite
Attivazione muto e disattivazione
Richiamo preset
Avanti/indietro traccia player
Stop
Play / Pausa player
Play USB (priorità)

Funzioni in abbinamento a TELEMACO:

Incremento / decremento volume ingressi / uscite
Attivazione muto e disattivazione
Richiamo preset
Avanti/indietro traccia player
Stop
Play / Pausa player

USCITE

4 uscite per collegamento di LED 12V. 3 modalità luce: fissa, lampeggio lento, lampeggio veloce. Per le seguenti funzioni:
Stato di muto player, ingressi e uscite
Stato di riproduzione player
Stato della connessione WiFi

Feedback pressione tasto
Alimentazione 110 - 230Vac.
Dimensioni (LxHxP) 44x44x18 mm.
Peso: 0,50Kg

EN - Remote control interface for P30S, P80S, MATRIX6, TELEMACO. WiFi connectivity. Webpage configuration.

INPUTS

4 button inputs with functions assignable via webpage programming.
Multi-function buttons (short and long press) to associate two functions to each single input.
The first two inputs can be used with rotary encoder (TVE) for volume control via knob.

Functions in combination with P30S, P80S:

Increment / decreasing volume inputs/ outputs
Mute and deactivation switch
Preset recall
Forward/backward track player
Stop
Play / Pause player
Left and right channel separate volume control
Play USB (priority)

Functions in conjunction with MATRIX6:

Increment / decreasing volume inputs/ outputs
Mute and deactivation switch
Preset recall
Forward/backward track player
Stop
Play / Pause player
Play USB (priority)

Functions in conjunction with TELEMACO:

Increment / decreasing volume inputs/ outputs
Mute and deactivation switch
Preset recall
Forward/backward track player
Stop
Play / Pause player

OUTPUTS

4 outputs for 12V LED connection. 3 light modes: fixed, slow flashing, fast flashing. For the following functions:
Mute player status, inputs and outputs
Player playback status
WiFi connection status

Feedback button press
Power supply 110 - 230vac.
Dimensions (WxHxD) 44x44x18 mm.
Weight: 0,50kg

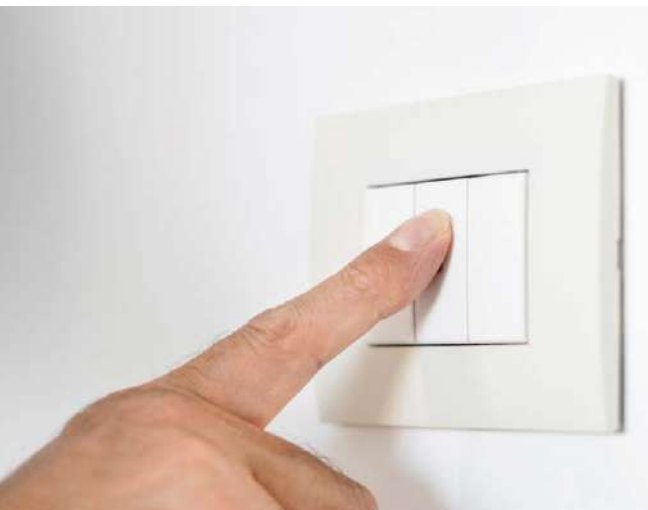

Esempio di pulsanti programmabili da C410.
Example of buttons programmable by C410.



EAN13 CODE



NEW 8052015550904 **TVE**



IT - Encoder per il controllo di volume, da associare al dispositivo C4IO. Fornito su tappo cieco. L'encoder è equipaggiato con un pulsante, il quale può essere associato ad una funzione di C4IO.

EN - Encoder for volume control, to be associated with the device C4IO. Supplied on blind cap. The encoder is equipped with a button, which can be associated with a function of C4IO.

Indicare al momento dell'ordine serie civile e colore desiderati.

Indicate when ordering civil series and color desired.

NEW 8051272189803 **AL6B**



IT - Alimentatore per 1 Telemaco. Da barra DIN (6 moduli). Input 100-240Vac 50Hz 1,8A. Output 24 Vdc 6,25A, 150W. Colore nero. Dimensioni (LxHxP) 103x58x90 mm. Peso 0,35Kg.

EN - DIN rail power supply for 1 Telemaco (6 modules) Input 100-240 Vac 50Hz 1,8A Output 24 Vdc 6,25A, 150W. Black colour. Dimensions 103x58x90 mm (WxHxD) Weight 0,35 Kg

8051272185270 **MICRO2.50** 50 mt

8051272185256 **MICRO2.100** 100 mt

8051272185263 **MICRO2.200** 200 mt



IT - Matassa di cavo microfonico 3mm (diametro esterno).

EN - Skein of microphone cable 3mm (outer diameter).





Keysol

Quando la tecnologia sposa lo stile, nasce l'emozione.

Vivaldi presenta una nuova gamma di prodotti con player multimediale Keysol integrato.

Vogliamo riempire la tua casa, il tuo giardino, il tuo ufficio, il tuo locale... di un suono brillante, potente, in ogni stanza.

Controlli WiFi.

Brani, podcast, web radio, audiolibri e molto altro, potrai riprodurre un audio diverso in ogni stanza o divertirti sincronizzando a piacere le zone, dando vita ad infinite combinazioni multiroom WiFi.

Scegli tra decine di servizi.

Svegli, timer, playlist, settaggi, programmazioni...

Vivaldi ti offre un'esperienza di gestione musicale, innovativa e semplice, mantenendo uno standard di alta qualità.

When technology is linked to style, emotion is born.

Vivaldi presents a new range of products with integrated Keysol multimedia player.

We want to fill your home, your garden, your office, your room... of a brilliant, powerful sound, in every room.

Wi-Fi controls.

Songs, podcasts, web radio, audiobooks and much more, you can play a different audio in each room or have fun synchronizing the areas at will giving life to infinite Wi-Fi multi room combinations.





L'App Vivaldi ti permette di accedere e gestire facilmente la musica preferita, le radio da tutto il mondo, i podcast, gli audiolibri o le prime parole di tua figlia. Potrai visualizzare le nostre news. Il design semplice ed intuitivo accompagna una tecnologia audio di ultima generazione.

Infinite "audiosoluzioni".

Vivaldi app comunica e interagisce con numerosi dispositivi Vivaldi senza cablaggi invasivi permette la ricerca di infiniti contenuti e la gestione personalizzata delle zone. Puoi intervenire su ogni singolo ambiente comodamente dal tuo dispositivo mobile.

Vivaldi App allows you to easily access and manage your favorite music, radios from all over the world, podcasts, audiobooks or your daughter's first words. You can view our news. The simple and intuitive design follows a latest generation of audio technology.

Endless "audio solutions".

Vivaldi app communicates and interacts with numerous Vivaldi devices without invasive wiring allows you to search for infinite contents and personalized management of zones. You can act on every single environment from the comfort of your mobile device.



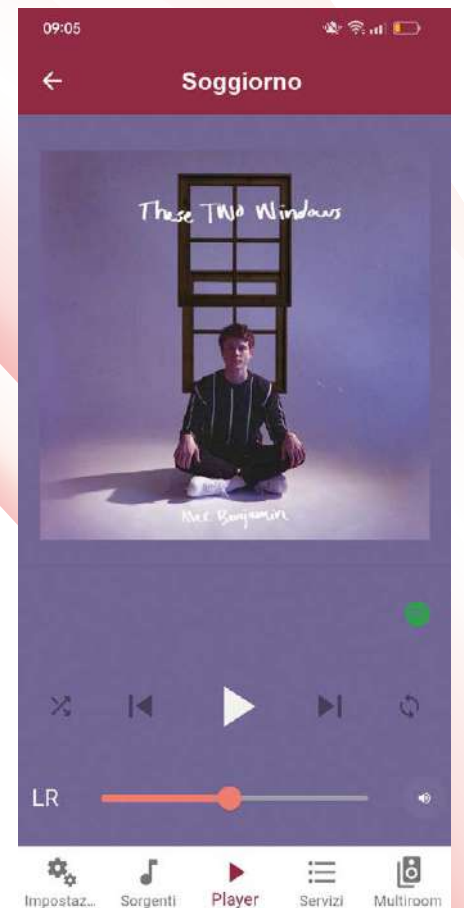
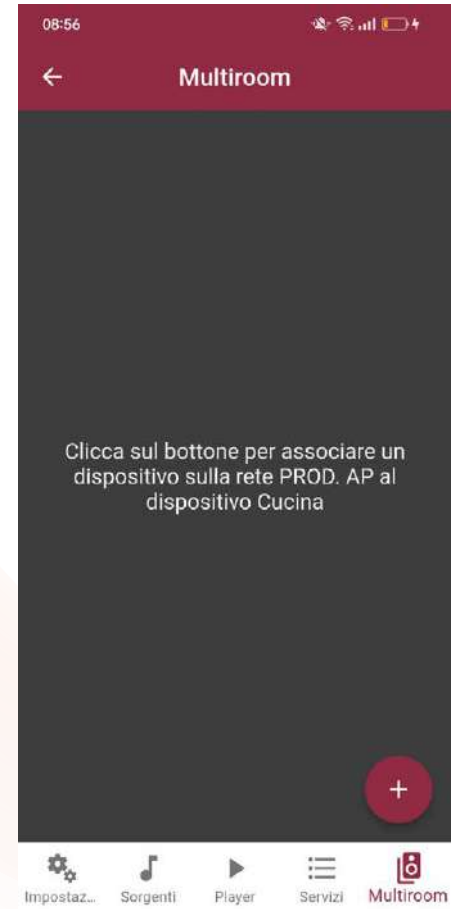
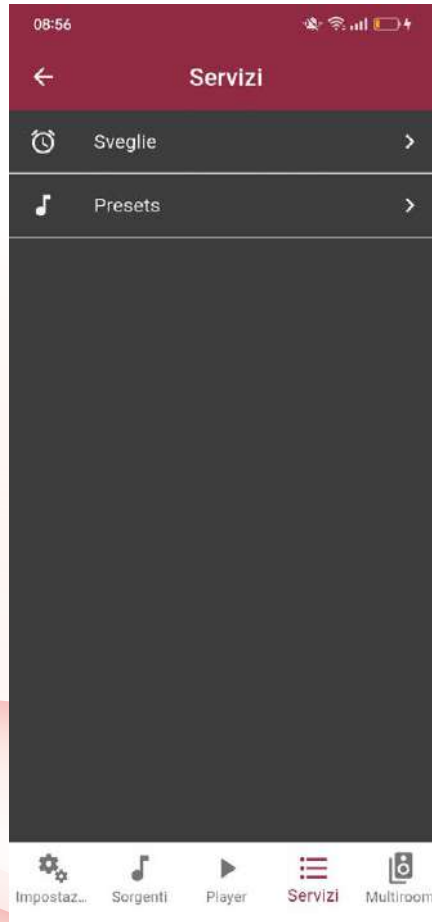
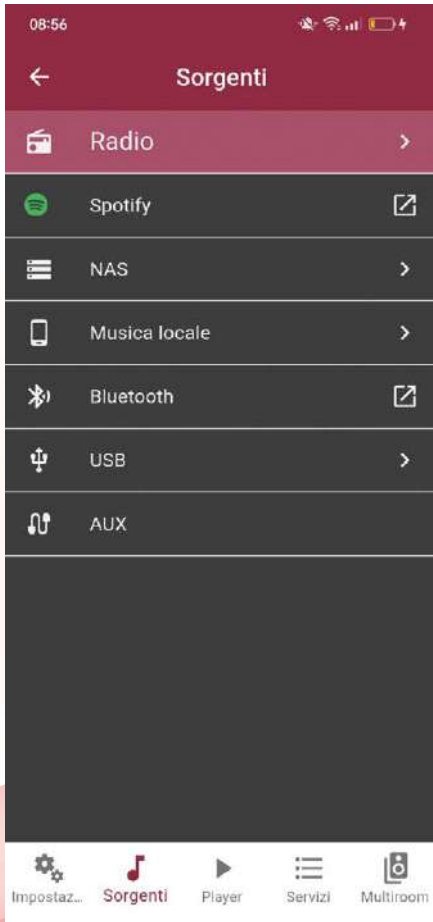



EAN13

CODE



8051272189766

KEYSOL-15S

8051272184563

KEYSOL tech data KEYSOL-15S without amplifiers, only source



IT - MEDIACENTER AUDIO ATTIVO SORGENTE MULTIMEDIALE WIFI E BLUETOOTH

HiFi Stereo 15W+15W RMS (30+30W musicali)

Riproduci musica da internet (Webradio, Spotify ...), dall'USB o dai tuoi dispositivi tramite il Bluetooth o la funzione AirPlay. Scarica l'App gratuita **Vivaldi** da Play Store e App Store.

CARATTERISTICHE TECNICHE

Attivo 15+15W.

APP di controllo gratuita: **Vivaldi** (compatibile con iOS - Android).

Supporta: Airplay, DLNA, WiFi DIRECT, Bluetooth.

Nome bluetooth "VIVALDI-KEYSOL".

Rete: 1xRJ45 per connessione alla rete LAN, WiFi Standard.

Ingressi Audio: 1x Analog Audio Input (Mini Jack Stereo 3,5mm).

Uscite Audio: 1x Analog Audio Output stereo (Mini Jack Stereo 3,5mm).

Sorgenti internet: Spotify, TuneIn, ecc.

Uscite audio amplificate 15W+15W per collegamento diffusori 4-8 Ω.

Sorgenti locali: musica residente nel proprio dispositivo mobile, streaming da NAS (disco di rete).

USB type A su frontale per riproduzione file audio

1x connettore alimentazione 15Vdc 2A (alimentatore fornito in dotazione).

Dimensioni 86x20x86 mm (LxHxP).

Peso 0,10 Kg.

Funzione sveglia con musica.
Telecomando fornito in dotazione.

EN - MEDIACENTER ACTIVE AUDIO MULTIMEDIA WIFI SOURCE AND BLUETOOTH

HiFi Stereo 15W+15W RMS (30+30W musical)

Play music from the internet (Webradio, Spotify ...), Bluetooth, Airplay, USB or from your devices. Download the free Vivaldi App from the Play Store and App Store.

TECHNICAL FEATURES

Active 15+15W.

Free control APP: **Vivaldi** (compatible with iOS - Android).

Supports: Airplay, DLNA, WiFi DIRECT, Bluetooth.

Bluetooth name "VIVALDI-KEYSOL".

Network: 1xRJ45 for LAN connection, WiFi Standard.

Audio Inputs: 1x Analog Audio Input (Mini Jack Stereo 3.5mm).

Audio Outputs: 1x Analog Audio Stereo Output (Mini Jack Stereo 3.5mm).

Internet sources: Spotify, TuneIn, etc.

Amplified audio outputs 15W+15W for connecting 4-8 Ω speakers.

Local sources: music in your mobile device, streaming from NAS (network disk).

USB type A on the front for audio file playback

1x 15Vdc 2A power connector (power supply included).

Size 86x20x86 mm (WxHxD).

Weight 0.10 kg.

Alarm clock function with music.
Remote control included.



MUSIC PLAYBACK



MULTI-CHANNEL



PLAYLIST PERSONALIZZATE



MULTIROOM



MULTI-SOURCE



AIRPLAY

KEYSOL



Tutti i marchi citati appartengono ai legittimi proprietari.
All trademarks mentioned belong to their legitimate owners.

KEOPE.S40, MINI8 or GIADA16F
SPEAKERS 8Ω
(MAX.2)

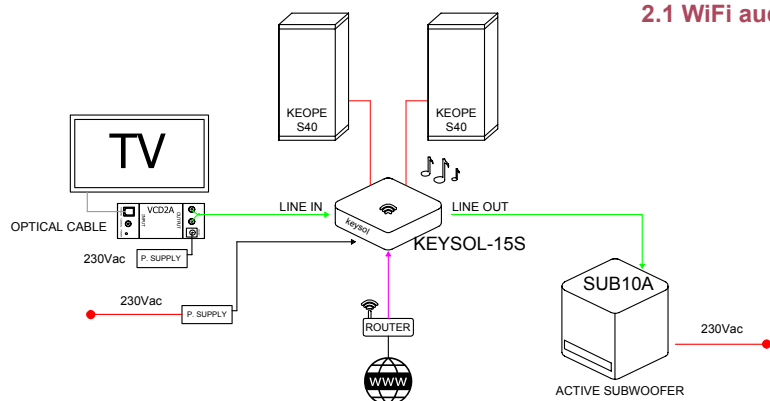

CABLE LEGEND

- CAVO DI ALIMENTAZIONE POLARIZZATO 2x1mm
POLARIZED CABLE FOR POWER SUPPLY 2x1mm
- CAVO MICRO2
MICRO2 CABLE
- CAVO OTTICO
OPTICAL CABLE
- CAVO CAT6
CAT6 CABLE

KEYSOL-15S ACTIVE 15+15W MULTIMEDIA PLAYER

- 2.1 WiFi audio streaming con ingresso per sorgente locale
- 2.1 WiFi audio streaming with local source input



bluetooth & WiFi streaming

APP (iOS & ANDROID)
gestione e controllo WiFi
WiFi manage and control



diffusori WiFi con player integrato
WiFi speakers with player built-in

VIVALDI

EAN13

CODE



8051272188097

KEOPE.S40WIFI

**calze colorate (da ordinare a parte)
colored covers (not included)**

pag.195-197



IT - Diffusore stereo ATTIVO multimediale con player Bluetooth & WiFi Keysol integrato.

APP di supervisione e controllo Vivaldi (scaricabile da iOS & Android).

Potenza amplificatore, con DSP, classe-D 40+40W RMS @ 8Ω.

Woofer 9 cm.

Tweeter 2,5 cm dome.

Risposta in frequenza 70-20000Hz +-5dB.

Max Output Level 101 dB. 104dB peak.

1 ingresso LINE.

1 ingresso Digitale (coax e optical toslink)

1 USB type A sul retro per riproduzione file audio MP3/WMA/AAC/AAC+/ALAC/FLAC/APE/WAV.

1 uscita di potenza per secondo diffusore passivo (slave speaker).

1 uscita di segnale mono (subwoofer attivi).

1 RJ45 per rete LAN.

Alimentatore input 100-240Vac, output 26Vdc (fornito in dotazione).

Dimensioni 110x235x130 mm (LxHxP).

Peso 3Kg.

Cabinet in legno.

Finiture alluminio spazzolato.

Calza colore di serie: nero.

Telecomando fornito in dotazione.

EN - ACTIVE multimedia stereo speaker kit with integrated Keysol WiFi & Bluetooth player.

Vivaldi supervision and control APP (downloadable from iOS & Android).

DSP, class-D power amplifier, 40+40W RMS @ 8Ω.

Woofer 9 cm.

Dome tweeter 2.5cm.

Frequency response 70-20000Hz +-5dB.

Maximum output level 101 dB. 104 dB peak.

1 LINE input.

1 TOSLINK optical and coax input.

1 USB Type-A on the rear for MP3/WMA/AAC/AAC+/ALAC/FLAC/APE/WAV audio file playback.

1 power output for second passive (slave) speaker.

1 mono signal output (active subwoofer).

1 RJ45 per LAN.

Power supply input 100-240Vac, output 26Vdc (included).Size 110x235x130 mm (WxHxD).

Weight 3Kg.

Wooden cabinet.

Brushed aluminium finishes.

Standard colored cover black.

Remote control included.



8051272188103

KEOPE.S80WIFI

**calze colorate (da ordinare a parte)
colored covers (not included)**

pag.195-197

IT - Come KEOPE.S40WIFI ma potenza amplificatore, con DSP, classe-D 70+70W RMS @ 4Ω.

Woofer 2x9 cm.

Tweeter 2,5 cm dome.

Risp. in freq. 65-20000Hz +-5dB.

Max Output Level 105dB.

108dB peak.

Dim. 110x450x130 mm (LxHxP).

Peso 4,5Kg.

EN - Like KEOPE. S40WIFI but DSP, class-D power amplifier 70+70W RMS @ 4Ω.

Woofer 2x9 cm.

Dome tweeter 2.5cm.

Frequency response 65-20000Hz +-5dB.

Max Output Level 105dB.

108dB peak.

Size 110x450x130 mm (WxHxD).

Weight 4,5Kg.

Tutti i marchi citati appartengono ai legittimi proprietari.
All trademarks mentioned belong to their legitimate owners.





EAN13

CODE



8051272188110

KEOPE.SOUNDB80WIFI

**calze colorate (da ordinare a parte)
colored covers (not included)**

pag.195-197

IT - Soundbar stereo ATTIVA multimediale con player Bluetooth & WiFi Keysol integrato.

APP di supervisione e controllo Vivaldi (scaricabile da iOS & Android).

Potenza amplificatore, con DSP, classe-D 40+40W RMS @ 8Ω.

Woofer 2x9 cm.

Tweeter 2x2,5 cm dome.

Risposta in frequenza 70-20000Hz +5dB.

Max Output Level 106 dB. 109dB peak.

1 ingresso LINE.

1 ingresso Digitale (coax e optical toslink)

1 USB type A sul retro per riproduzione

file audio MP3/WMA/AAC/AAC+/ALAC/

FLAC/APE/WAV.

1 uscita di segnale mono (subwoofer attivi).

1 RJ45 per rete LAN.

Alimentatore input 100-240Vac, output

26Vdc (fornito in dotazione).

Dimensioni 615x110x130 mm (LxHxP).

Peso 3,5Kg.

Cabinet in legno.

Finiture alluminio spazzolato.

Calza colore di serie: nero.

Telecomando fornito in dotazione.

EN - ACTIVE multimedia stereo soundbar kit with integrated Keysol WiFi & Bluetooth player.

Vivaldi supervision and control APP (downloadable from iOS & Android).

DSP, class-D power amplifier, 40+40W RMS @ 8Ω.

Woofer 2x9 cm.

Dome tweeter 2x2.5 cm.

Frequency response 70-20000Hz +5dB.

Maximum output level 106 dB. Peak of

109 dB.

1 LINE input.

1 Digital input (coaxial and toslink)

1 USB Type-A on the rear for MP3/WMA/

AAC/AAC+/ALAC/FLAC/APE/WAV audio

file playback.

1 mono signal output (active subwoofer).

1 RJ45 per LAN.

Power supply input 100-240Vac, output

26Vdc (included).

Size 615x110x130 mm (WxHxD).

Weight 3,5Kg.

Wooden cabinet.

Brushed aluminium finishes.

Standard colored cover black.

Remote control included.



8051272188127

KEOPE.SOUNDB160WIFI

**calze colorate (da ordinare a parte)
colored covers (not included)**

pag.195-197

IT - Come KEOPE.SOUNDB80WIFI ma potenza amplificatore, con DSP, classe-D 70+70W RMS @ 4Ω.

Woofer 4x9 cm. Tweeter 2x2,5 cm dome.

Risp. in freq. 70-20000Hz +5dB. Max

Output Level 111dB.

114dB peak. Dim. 915x110x130 mm

(LxHxP). Peso 7 kg.

EN - Like KEOPE. SOUNDB80WIFI with DSP, class-D power amplifier, 70+70W RMS @ 4Ω.

Woofer 4x9 cm. Dome tweeter 2x2.5 cm.

Frequency response. 70-20000Hz

+5dB. Maximum output level 111dB.

114 dB peak.

Size 915x110x130 mm (WxHxD).

Weight 7 kg.





diffusori WiFi con player integrato
WiFi speakers with player built-in

VIVALDI

EAN13

CODE

Spotify +tunein dlna



8051272189858

KEOPE.HP60WIFI

**calze colorate (da ordinare a parte)
colored covers (not included)**

pag.195-197



IT - Diffusore stereo ATTIVO multimediale con player Bluetooth & WiFi Keysol integrato.

APP di supervisione e controllo Vivaldi (scaricabile da iOS & Android).

Potenza amplificatore, con DSP, classe-D 40+40W RMS @ 8Ω.

Woofer 15 cm.

Tweeter 2,5 cm dome.

Risposta in frequenza 65-20000Hz +-5dB.

Max Output Level 106 dB. 109dB peak.

1 ingresso LINE.

1 ingresso Digitale (coax e optical toslink)

1 USB type A sul retro per riproduzione file audio MP3/WMA/AAC/AAC+/ALAC/FLAC/APE/WAV.

1 uscita di potenza per secondo diffusore passivo (slave speaker).

1 uscita di segnale mono (subwoofer attivi).

1 RJ45 per rete LAN.

Alimentatore input 100-240Vac, output 26Vdc (fornito in dotazione).

Dimensioni 172x275x210 mm (LxHxP)
Peso 6,5Kg

Cabinet in legno.

Finiture alluminio spazzolato.

Calza colore di serie: nero.

Telecomando fornito in dotazione.

EN - ACTIVE multimedia stereo speaker with integrated Keysol WiFi & Bluetooth player.

Vivaldi supervision and control APP (downloadable from iOS & Android).

DSP, class-D power amplifier, 40+40W RMS @ 8Ω.

Woofer 15 cm.

Dome tweeter 2.5cm.

Frequency response 65-20000Hz +-5dB.

Max Output Level 106 dB. 109dB peak.

1 LINE input.

1 Digital input (coax and optical toslink)

1 USB type A on the rear for MP3/

WMA/AAC/AAC+/ALAC/FLAC/APE/

WAV audio file playback.

1 power output for second passive (slave) speaker.

1 mono signal output (active subwoofer).

1 RJ45 per LAN.

Power supply input 100-240Vac, output 26Vdc (included).

Size 172x275x210 mm (WxHxD)
Weight 6,5Kg. Wooden cabinet.

Brushed aluminum finishes.

Standard colored cover black.
Remote control included.



8051272189865

KEOPE.M250WIFI

**calze colorate (da ordinare a parte)
colored covers (not included)**

pag.195-197

IT - Diffusore stereo ATTIVO multimediale con player Bluetooth & WiFi Keysol integrato.

APP di supervisione e controllo Vivaldi (scaricabile da iOS & Android).

Potenza amplificatore, con DSP, classe-D 70+70W RMS @ 4Ω.

Woofer 2x15 cm. Tweeter 2,5 cm dome. Risposta in frequenza 45-20000Hz +-5dB. Max Output Level 112dB. 115 peak.

1 ingresso LINE.

1 ingresso Digitale (coax e optical toslink)

1 USB type A sul retro per riproduzione file audio MP3/WMA/AAC/AAC+/ALAC/FLAC/APE/WAV.

1 uscita di potenza per secondo diffusore passivo (slave speaker).

1 uscita di segnale mono (subwoofer attivi).

1 RJ45 per rete LAN.

Alimentatore input 100-240Vac, output 26Vdc (fornito in dotazione).

Dimensioni 172x1015x210 mm (LxHxP).

Peso 14Kg. Cabinet in legno. Finiture alluminio spazzolato.

Calza colore di serie: nero.

Telecomando fornito in dotazione.

EN - ACTIVE multimedia stereo speaker kit with integrated Keysol WiFi & Bluetooth player.

Vivaldi supervision and control APP (downloadable from iOS & Android).

DSP, class-D power amplifier, 70+70W RMS @ 4Ω.

Woofer 2x15 cm. Dome tweeter 2.5cm. Frequency response 45-20000Hz +-5dB. Maximum output level 112dB. 115 peak.

1 LINE input.

1 Digital input (coaxial and Toslink)

1 USB Type-A on the rear for MP3/

WMA/AAC/AAC+/ALAC/FLAC/APE/

WAV audio file playback.

1 power output for second passive (slave) speaker.

1 mono signal output (active subwoofer).

1 RJ45 per LAN.

Power supply input 100-240Vac, output 26Vdc (included).

Size 172x1015x210 mm (WxHxD).
Weight 14Kg.

Wooden cabinet. Brushed aluminium finishes. Standard colored cover black.
Remote control included.

Tutti i marchi citati appartengono ai legittimi proprietari.
All trademarks mentioned belong to their legitimate owners.

EAN13

CODE



8051272187717 **KEYROUND16AF**

8051272187724 **KEYROUND16AF.R** (min 10pz)



KIT multimediale con tecnologia WiFi e Bluetooth composto da:
n. 1 diffusore KEYROUND16AF con integrazione multimediale Keysol.
n. 1 diffusore ROUND16F
n.1 telecomando

DETTAGLIO PRODOTTO

n. 01 - KEYROUND16AF MASTER

diffusore MASTER rotondo, serie design Frameless, semi-filomuro, da incasso a soffitto.

ATTIVO, 2 vie, 2x30W RMS, HI-FI, **con player multimediale WiFi Keysol e Bluetooth integrati.**

Porta LAN per connessione di rete (RJ45).

1 ingresso stereo RCA ausiliario per sorgente esterna.

1 uscita di potenza per diffusore SLAVE (30W RMS).

Alimentatore di sistema 24V, 2,5A (fornito in dotazione).

Woofer 16,5 cm

Tweeter da 1,9 cm a cupola orientabile, in titanio, magnete al neodimio

Potenza 2x30W RMS

Potenza musicale 2x60W

Risposta in frequenza 60-20000 Hz

Sensibilità 90 dB

Angolo di dispersione 120° (V/O)

Cabinet ABS V0 con griglia di protezione zincata verniciata.

Temperatura di lavoro da -20° a +65°.

Dimensioni (DxP) 227x100 mm

Foro da incasso (D) 210 mm

Peso 1,8 Kg

n. 01 - ROUND16F SLAVE

diffusore SLAVE rotondo, 2 vie da incasso, **HI-FI, Frameless**

Impedenza 8 Ω

Incasso su cartongesso, pareti di legno e simili: non servono accessori, il diffusore nel retro è dotato di ganci per l'ancoraggio stabile.

Incasso su muratura: non adatto.

Colore bianco RAL 9016, verniciabile

Cabinet ABS V0 con griglia di protezione zincata verniciata.

Temperatura di lavoro da -20° a +65°.

Telecomando fornito in dotazione.

Multimedia WiFi e Bluetooth speakers kit:
1pc KEYROUND16AF speaker with built-in Keysol
1pc ROUND16F
1pc remote control

SPECIFICATIONS

n. 01 - KEYROUND16AF MASTER

round MASTER speaker, Frameless design series, semi-flush wall, recessed ceiling.

ACTIVE, 2-way, 2x30W RMS, HI-FI, **with built-in multimedia player Bluetooth WiFi Keysol.**

Network LAN port for connection (RJ45).

1 auxiliary stereo RCA input for external source.

1 power output for SLAVE speaker (30W RMS).

System power supply 24V, 2.5A (included).

Woofer 16.5 cm.

Titanium adjustable dome tweeter with neodymium magnet 1.9 cm

RMS Power 2x30W

Musical Power 2x60W

Frequency response 60-20000 Hz

Sensitivity 90 dB

Dispersion angle 120° (V / H)

ABS V0 cabinet with painted galvanized protection grille.

Working temperature from -20° to +65°.

Size (DxD) 227x100 mm

Built-in hole (D) 210 mm

Weight 1,8 Kg

n. 01 - ROUND16F SLAVE

Round speaker, 2 way in-ceiling, **HI-FI, Frameless**

Impedance: 8Ω

Recessed on drywall, wood walls and similar: no accessories need, the speaker is provided with some hooks for stable anchoring in the rear side.

Installation in-wall: not suitable

White colour RAL 9016, paintable

ABS V0 cabinet with painted galvanized grille.

Working temperature from -20° to +65°.

Remote control included.



diffusori WiFi con player integrato
WiFi speakers with player built-in

VIVALDI

EAN13

CODE



8051272189940 **KBOX**



IT - Amplificatore multimediale Bluetooth e WiFi con player multimediale integrato. Con ingressi per sorgenti locali ed uscite per 1 o 2 diffusori.
Streaming musicale, riproduzioni e controlli tramite **VIVALDI APP**.

CARATTERISTICHE TECNICHE

- Ricevitore Bluetooth integrato.
- Ricevitore WiFi integrato.
- APP di controllo gratuita: Vivaldi APP (compatibile con iOS - Android).
- Supporta: Airplay, DLNA, WiFi DIRECT.
- Formati audio: AAC/LTP, HE-AACv1, HE-AACv2, AMR-NB, AMR, WB, FLAC, MP3, Vorbis, PCM/WAVE, ALAC.
- Rete: 1xRJ45, WiFi Standard: IEEE802.11b, IEEE802.11g, IEEE802.11n.
- Ingressi Audio: 1x Minijack stereo analogico.
- **Uscite Audio: Stereo con potenza amplificatore classe-D 40+40W @ 8-16Ω, non compatibile con diffusori a 4Ω.**
- **Sorgenti internet: Spotify, Tuneln, ecc.**
- Sorgenti locali: musica residente nel proprio dispositivo mobile, streaming da NAS (disco di rete).
- 3 Modalità di utilizzo:
 1. One song-One Room: utilizzo di un singolo dispositivo.
 2. One song-Multiple Rooms: utilizzo di più dispositivi per musiche differenti.
 3. One song-All Rooms: utilizzo di più dispositivi per la stessa musica sincronizzata.
- Alimentazione 24Vdc tramite alimentatore in dotazione.
- Contenitore stagno IP65, per installazione all'esterno.
- Colore grigio.
- 3x pressacavi in dotazione.
- Certificazioni: CE, ROHS.
- Dimensioni (LxHxP): 180x230x120 mm.
- Peso 0,45 Kg.

EN - Bluetooth and WiFi multimedia amplifier with integrated multimedia player. With input for external source and outputs for 1 or 2 speakers.
Music streaming, playback and controls via **VIVALDI APP**.

TECHNICAL FEATURES

- Built-in Bluetooth receiver.
- Built-in WiFi receiver.
- Free control APP: Vivaldi APP (compatible with iOS - Android).
- Supports: Airplay, DLNA, WiFi DIRECT.
- Audio formats: AAC/LTP, HE-AACv1, HE-AACv2, AMR-NB, AMR, WB, FLAC, MP3, Vorbis, PCM/WAVE, ALAC.
- Network: 1xRJ45, WiFi Standard: IEEE802.11b, IEEE802.11g, IEEE802.11n.
- Audio Input: 1x Analog stereo minijack.
- **Audio Output: Stereo power amplifier class-D 40+40W @ 8-16Ω, not compatible with 4Ω speakers.**
- **Internet sources: Spotify, Youtube, Tunein, etc.**
- Local sources: music residing on your mobile device, streaming from NAS (network disk).
- 3 How to use:
 1. One song-One Room: use of a single device.
 2. One song-Multiple Rooms: use of multiple devices for different music.
 3. One song-All Rooms: use multiple devices for the same synchronized music.
- 24vdc power supply included.
- IP65 watertight enclosure, for outdoor installation.
- Colour: grey.
- 3x supplied cable glands.
- Certifications: CE, ROHS.
- Dimensions (WxHxD): 180x230x120 mm.
- Weight 0.45 Kg.





IP56 8051272189780

KEYROCK20A



IT - Kit diffusore Wireless & Bluetooth per il giardino e gli spazi all'aperto.

Streaming bluetooth dal proprio dispositivo (smartphone, pc, tablet ...). Streaming WiFi tramite APP VIVALDI (iOS, Android) con YouTube, Spotify, WebRadio, NAS, ecc...

Composto da:

1) KBOX

Amplificatore multimediale Bluetooth e WiFi con player multimediale integrato.

Con ingressi per sorgenti locali. Streaming musicale, riproduzioni e controlli tramite VIVALDI APP.

Uscite Audio: Stereo con potenza amplificatore classe-D **40+40W @ 8-16Ω**, non compatibile con diffusori a 4Ω.

Alimentazione 24Vdc tramite alimentatore in dotazione.

Contenitore stagno IP65, per installazione all'esterno.

Colore grigio.

3x pressacavi in dotazione.

Dimensioni (LxHxP): 180x230x120 mm.

Peso 0,45 Kg.

1) ROCK20T

Diffusore simil roccia, 2 vie coax, **Hi-Fi**, da giardino **IP56** waterproof.

Woofers: 20 cm in polipropilene.

Tweeter: 2,5cm in titanio con magnete al neodimio.

Dimensioni (LxHxP) 440x300x300 mm.

Colore grigio simil roccia.

Cabinet: fibra di vetro verniciata.

Angolo di dispersione: 120°(O) x120°(V).

Temperatura di lavoro da -20° a +60°.

EN - Wireless & Bluetooth speaker kit for garden and outdoor environment.

Bluetooth streaming from your device (smartphone, pc, tablet ...).

WiFi streaming via VIVALDI APP (iOS, Android) with YouTube, Spotify, Webradio, NAS, etc...

Included:

1) KBOX

Bluetooth and WiFi amplifier with integrated multimedia player.

With input for external source. Music streaming, playback and controls via VIVALDI APP.

Audio Output: Stereo power amplifier class-D **40+40W @ 8-16Ω**, not compatible with 4Ω speakers.

24vdc power supply included. IP65 watertight enclosure, for outdoor installation.

Colour: Grey.

3x cable glands included.

Dimensions (WxHxD): 180x230x120 mm.

Weight 0.45 Kg.

1) ROCK20T

Rock-like speaker, 2-way coax, **Hi-Fi**, garden **IP56** waterproof.

Woofers: 20 cm in polypropylene.

Tweeter: 2.5cm titanium with neodymium magnet.

Dimensions (WxHxD) 440x300x300 mm.

Rock-like grey colour.

Cabinet: painted fiberglass.

Dispersion angle: 120° (H)x120° (V).

Working temperature from -20° to +60°.





EAN13

CODE



IP56 8052015550966 **KEYGREEN16A**



IT - Kit diffusore Wireless & Bluetooth per il giardino e gli spazi all'aperto.

Streaming bluetooth dal proprio dispositivo (smartphone, pc, tablet ...). Streaming WiFi tramite APP VIVALDI (iOS, Android) con YouTube, Spotify, WebRadio, NAS, ecc...

Composto da:

1) KBOX

Amplificatore multimediale Bluetooth e WiFi con player multimediale integrato. Con ingressi per sorgenti locali.

Streaming musicale, riproduzioni e controlli tramite VIVALDI APP.

Uscite Audio: Stereo con potenza amplificatore classe-D **40+40W @ @ 8-16Ω**, non compatibile con diffusori a 4Ω.

Alimentazione 24Vdc tramite alimentatore in dotazione.

Contenitore stagno IP65, per installazione all'esterno.

Colore grigio.

3x pressacavi in dotazione.

Dimensioni (LxHxP): 180x230x120 mm.

Peso 0,45 Kg.

1) GREEN16T

Diffusore, 2 vie coax, **Hi-Fi**, da giardino **IP56** waterproof.

Woofer: 16,5 cm in polipropilene.

Tweeter: 3 cm in titanio magnete neodimio.

Dimensioni (DxH) 365x409 mm.

Peso 3 Kg.

Colore verde.

Cabinet: polipropilene UV.

Angolo di dispersione: 360°(O)x40°(V).

Temperatura di lavoro da -20° a +60°.

EN - Wireless & Bluetooth speaker kit for garden and outdoor environment.

Bluetooth streaming from your device (smartphone, pc, tablet ...).

WiFi streaming via VIVALDI APP (iOS, Android) with YouTube, Spotify, Webradio, NAS, etc...

Included:

1) KBOX

Bluetooth and WiFi amplifier with integrated multimedia player.

With input for external source. Music streaming, playback and controls via VIVALDI APP.

Audio Output: Stereo power amplifier class-D **40+40W @ 8-16Ω**, not compatible with 4Ω speakers.

24vdc power supply included.

IP65 watertight enclosure, for outdoor installation.

Colour: Grey.

3x cable glands included.

Dimensions (WxHxD): 180x230x120 mm.

Weight 0.45 Kg.

1) GREEN16T

Speaker, 2-way coax, **Hi-Fi**, garden **IP56** waterproof.

Woofer: 16,5 cm in polypropylene.

Tweeter: 3 cm titanium with neodymium magnet.

Dimensions (WxH) 365x409 mm.

Colour: Green.

Cabinet: UV polypropylene.

Dispersion angle: 360°(H)x40°(V).

Working temperature from -20° to +60°.

EAN13

CODE



NEW IP65 8052015550973 **KEYZEN315A**



IT - Kit diffusore Wireless & Bluetooth per il giardino e gli spazi all'aperto.

Streaming bluetooth dal proprio dispositivo (smartphone, pc, tablet ...). Streaming WiFi tramite APP VIVALDI (iOS, Android) con YouTube, Spotify, WebRadio, NAS, ecc...

Composto da:

1) KBOX

Amplificatore multimediale Bluetooth e WiFi con player multimediale integrato.

Con ingressi per sorgenti locali. Streaming musicale, riproduzioni e controlli tramite VIVALDI APP.

Uscite Audio: Stereo con potenza amplificatore classe-D **40+40W @ @ 8-16Ω**, non compatibile con diffusori a 4Ω.

Alimentazione 24Vdc tramite alimentatore in dotazione.

Contenitore stagno IP65, per installazione all'esterno.

Colore grigio.

3x pressacavi in dotazione.

Dimensioni (LxHxP): 180x230x120 mm.

Peso 0,45 Kg.

1) ZEN315

Diffusore di design, HiFi, 2 vie, in acciaio Inox 316L, IP65, per diffusioni sonore ed arredamenti da esterno (terrazze, giardini, piscine...).

Woofer da 16,5cm.

Tweeter a cupola da 2,5cm.

Dimensioni 205x315 mm (DxH).

Flangia di ancoraggio 30 cm (D).

Fori di ancoraggio nr. 3.

Peso 7 Kg.

Colore acciaio spazzolato.

Personalizzazione colore su richiesta.

EN - Wireless & Bluetooth speaker kit for gardens and outdoor environments.

Bluetooth streaming from your device (smartphone, pc, tablet ...).

WiFi streaming via VIVALDI APP (iOS, Android) with YouTube, Spotify, Webradio, NAS, etc...

Included:

1) KBOX

Bluetooth and WiFi amplifier with integrated multimedia player.

With input for external source. Music streaming, playback and controls via VIVALDI APP.

Audio Output: Stereo power amplifier class-D **40+40W @ 8-16Ω**, not compatible with 4Ω speakers. 24vdc power supply included.

IP65 watertight enclosure, for outdoor installation.

Colour: Grey.

3x cable glands included.

Dimensions (WxHxD): 180x230x120 mm.

Weight 0.45 Kg.

1) ZEN315

Speaker design, hifi, 2-way, in 316L stainless steel, IP65, for sound broadcasting in outdoor environments (terraces, gardens, swimming pools...).

16.5 cm woofer.

2.5cm dome tweeter.

Dimensions 205x315 mm (WxH).

Anchor flange 30 cm (D).

Anchoring holes nr. 3.

Weight 7 Kg.

Colour brushed steel.

Color customization on request.

NEW IP65 8052015550980 **KEYZEN510A**



IT - Come KEYZEN315A ma composto da 1 ZEN510 Diffusore di design con illuminazione a LED integrata 66 Led, 13,8W, 1380lm, 3800K. Dimensioni 205x510 mm (DxH). Peso 8,2 Kg.

EN - Like KEYZEN315A but composed of 1 ZEN510 Design diffuser with integrated LED lighting 66 Led, 13.8W, 1380lm, 3800K. Dimensions 205x510 mm (WxH). Weight 8.2kg.



EAN13

CODE



NEW IP56 8052015550997 **KEYZEN730A**



IT - Kit diffusore Wireless & Bluetooth per il giardino e gli spazi all'aperto.

Streaming bluetooth dal proprio dispositivo (smartphone, pc, tablet ...). Streaming WiFi tramite APP VIVALDI (iOS, Android) con YouTube, Spotify, WebRadio, NAS, ecc...

Composto da:

1) KBOX

Amplificatore multimediale Bluetooth e WiFi con player multimediale integrato. Con ingressi per sorgenti locali.

Streaming musicale, riproduzioni e controlli tramite VIVALDI APP.

Uscite Audio: Stereo con potenza amplificatore classe-D **40+40W @ @ 8-16Ω**, non compatibile con diffusori a 4Ω.

Alimentazione 24Vdc tramite alimentatore in dotazione.

Contenitore stagno IP65, per installazione all'esterno.

Colore grigio.

3x pressacavi in dotazione.

Dimensioni (LxHxP): 180x230x120 mm.

Peso 0,45 Kg.

1) ZEN730

Diffusore di design, HiFi, 2 vie, in acciaio Inox 316L, IP65, per diffusioni sonore ed arredamenti da esterno (terrazze, giardini, piscine...).

Woofer da 16,5cm.

Tweeter da 2,5cm a compressione.

Dimensioni 205x725 mm (DxH).

Flangia di ancoraggio 30 cm (D).

Fori di ancoraggio nr. 3.

Peso 12,5 Kg.

Colore acciaio spazzolato.

Personalizzazione colore su richiesta.

EN - Wireless & Bluetooth speaker kit for gardens and outdoor environments.

Bluetooth streaming from your device (smartphone, pc, tablet ...).

WiFi streaming via VIVALDI APP (iOS, Android) with YouTube, Spotify, Webradio, NAS, etc...

Included:

1) KBOX

Bluetooth and WiFi amplifier with integrated multimedia player.

With input for external source. Music streaming, playback and controls via VIVALDI APP.

Audio Output: Stereo power amplifier class-D **40+40W @ 8-16Ω**, not compatible with 4Ω speakers. 24vdc power supply included.

IP65 watertight enclosure, for outdoor installation.

Colour: Grey.

3x cable glands included.

Dimensions (WxHxD): 180x230x120 mm.

Weight 0.45 Kg.

1) ZEN730

Speaker design, hifi, 2-way, in 316L stainless steel, IP65, for sound broadcasting in outdoor environments (terraces, gardens, swimming pools...).

16,5 cm woofer.

2,5cm dome tweeter.

Dimensions 205x725 mm (WxH).

Anchor flange 30 cm (D).

Anchoring holes nr. 3.

Weight 12,5 Kg.

Colour brushed steel.

Color customization on request.



esempio di personalizzazione nero opaco RAL 9005

example of customization black matt RAL 9005

EAN13 CODE

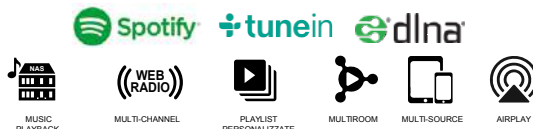

8051272189759 **KEYSOL-DIN**



IT - MEDIACENTER AUDIO da BARRA DIN SORGENTE MULTIMEDIALE WIFI
Riproduci musica da internet (Webradio, Spotify ...), dall'USB o dai tuoi dispositivi.
Scarica l'App gratuita Vivaldi su Play Store e App Store.

- APP gratuita: Vivaldi (compatibile con iOS - Android).
- Supporta: Airplay, DLNA, WiFi DIRECT.
- Formati audio: AAC/LTP, HE-ACCv1, HE-ACCv2, AMR-NB, AMR, WB, FLAC, MP3, Vorbis, PCM/WAVE, ALAC.
- Rete: 1xRJ45 per connessione alla rete LAN, WiFi Standard: IEEE802.11b, IEEE802.11g, IEEE802.11n.
- 1x Analog Audio Input stereo sbilanciato.
- 1x Analog Audio Output stereo bilanciata.
- Sorgenti internet: Spotify, TuneIn, ecc...
- Sorgenti locali: musica residente nel proprio dispositivo mobile, streaming da NAS (disco di rete).
- USB type A su frontale per riproduzione file audio MP3/WMA/AAC/AAC+/ALAC/FLAC/APE/WAV.
- 1x Morsetto alimentazione 24Vdc (alimentatore AL2B in dotazione).
- 1x SMA presa per connessione antenna 2.4Ghz WIFI.
- Personalizzazione nomi dispositivi.
- Gestione sveglia con musica.
- Certificazioni: CE, ROHS.
- Dimensioni (LxHxP) 18x90x63 mm (1 Modulo DIN)
- Peso 0.10 Kg.
- AL2B in dotazione

EN - MEDIACENTER AUDIO from DIN BAR. WIFI MULTIMEDIA SOURCE
Play music from the internet (Webradio, Spotify ...), from USB or from your devices.
Download the Vivaldi for free on Play Store and App Store.

- Free APP: Vivaldi (compatible with iOS - Android).
- Supports: Airplay, DLNA, WiFi DIRECT.
- Audio formats: AAC/LTP, HE-ACCv1, HE-ACCv2, AMR-NB, AMR, WB, FLAC, MP3, Vorbis, PCM/WAVE, ALAC.
- Network: 1xRJ45 for LAN connection, WiFi Standard: IEEE802.11b, IEEE802.11g, IEEE802.11n.
- Audio inputs: 1x Analog Audio Stereo Unbalanced.
- Audio outputs: 1x Analog Audio Stereo Balanced.
- Internet sources: Spotify, TuneIn, etc.
- Local sources: music residing in your mobile device, streaming from NAS (network disk).
- USB type A on front for audio playback MP3/WMA/AAC/AAC+/ALAC/FLAC/APE/WAV.
- 1x power supply clamp 24Vdc (power supply AL2B included).
- 1x SMA socket for 2.4Ghz antenna for WIFI connection.
- Customization device names.
- Alarm clock management with music.
- CE, ROHS certifications.
- Size (WxHxD) 18x90x63 mm (1 Module DIN)
- Weight 0.10 Kg.
- AL2B included

8051272180978 **P40SL**



IT - Amplificatore stereo multimediale con player Keysol integrato. Potenza classe-D 40+40W @ 8Ω, 70+70W @ 4Ω.
APP di supervisione e controllo Vivaldi (scaricabile da iOS & Android).
1 INGRESSO LINE.
1 INGRESSO DIGITALE TOSLINK e RCA.
1 USCITA STEREO BILANCIATA per espansioni di potenza (A25SBTC, E30S, E80S, finali di potenza Linea Vivaldi Ulisse a 8Ω/100V) o subwoofer attivi.
1x RJ45 per rete LAN.
1x cavo PATCH da 1mt.
Controllo parametri audio con gestione volumi/settaggi da App.
Alimentazione 24Vdc tramite AL5B (da ordinare a parte).
Standard DIN (6 moduli).
Dimensioni (LxHxP): 108x90x63 mm.
Peso 0.25 Kg.

EN - Multimedia class-D stereo power amplifier with integrated Keysol player. 40+40W @ 8Ω, 70+70W @ 4Ω.
Vivaldi supervision and control APP (downloadable from iOS & Android).
1 LINE INPUT.
1 TOSLINK and RCA DIGITAL INPUT.
1 BALANCED STEREO OUTPUT for power expansions (A25SBTC, E30S, E80S, 8Ω/100V Vivaldi Ulisse Line power amps) or active subwoofers.
1x RJ45 per LAN.
1x PATCH cable 1mt included.
Audio parameter control with volume/settings from App.
Power supply 24Vdc via AL5B (not included).
DIN standard (6 modules).
Size (WxHxD): 108x90x63 mm.
Weight 0.25 Kg.



dispositivi audio multimediali controllabili da APP
multimedia audio devices managed by APP

VIVALDI

EAN13 CODE



8051272188769 **MATRIX6**



IT - Matrice a 6 ingressi + 1 sorgente, domotica, con player multimediale integrato. APP di supervisione e controllo VIVALDI (scaricabile da iOS & Android). API disponibili:

- KNXnet-IP (KNX IP Router necessario non di nostra fornitura)
 - Protocollo MQTT 3.1 (tramite Broker esterno oppure integrato)
 - REST-API (HTTP GET/POST)
- 6x INGRESSI MIC/LINE selezionabili con Phantom attivabile (24Vdc), priorità assegnabile (attivabile con contatto). USB type A su frontale per riproduzione file audio MP3/WMA/AAC/AAC+/ALAC/FLAC/APE/WAV. Equalizzatore a 3 bande. Uscite per espansioni di potenza E30S, E80S o finali di potenza Linea Vivaldi Ulisse a 80Ω o 100V. 1x RJ45 per rete LAN. 1x cavo PATCH da 1mt.

Controllo parametri audio con gestione volumi/settaggi/... da webpage. Integrabile a domotiche terze o ai dispositivi domotici multiprotocollo iCONTROL4.1L, iCONTROL4.0+ tramite rete LAN. Alimentazione 24Vdc tramite AL2B (non in dotazione). Standard DIN (6 moduli). Dimensioni (LxHxP): 106x90x63 mm. Peso 0.2 Kg.

EN - Multimedia stereo device with DSP and multimedia player embedded. Matrix 6 inputs + 1 source. VIVALDI supervision and control APP (downloadable from iOS & Android).

- API available:**
- KNXnet-IP (KNX IP mandatory Router is not provided)
 - Protocollo MQTT 3.1 (through external Broker or integrated)
 - REST-API (HTTP GET/POST)
- 6x SELECTABLE MIC/LINE INPUTS with activable Phantom (24Vdc), assignable priority (can be activated with contact). USB Type A on the front for MP3/WMA/AAC/AAC+/ALAC/FLAC/APE/WAV audio file playback. 3-band equalizer. Outputs for power expansions E30S, E80S or power amps Vivaldi Ulisse Line at 80Ω or 100V. 1x RJ45 per LAN. 1x PATCH cable 1mt. Audio parameter control with volume/settings/... from webpage. Can be integrated with home automation systems iCONTROL4.1L, iCONTROL4.0+ via LAN. Power Supply 24Vdc via AL2B (not included). DIN standard (6 modules). Dimensions (WxHxD): 106x90x63 mm. Weight 0.2 Kg.

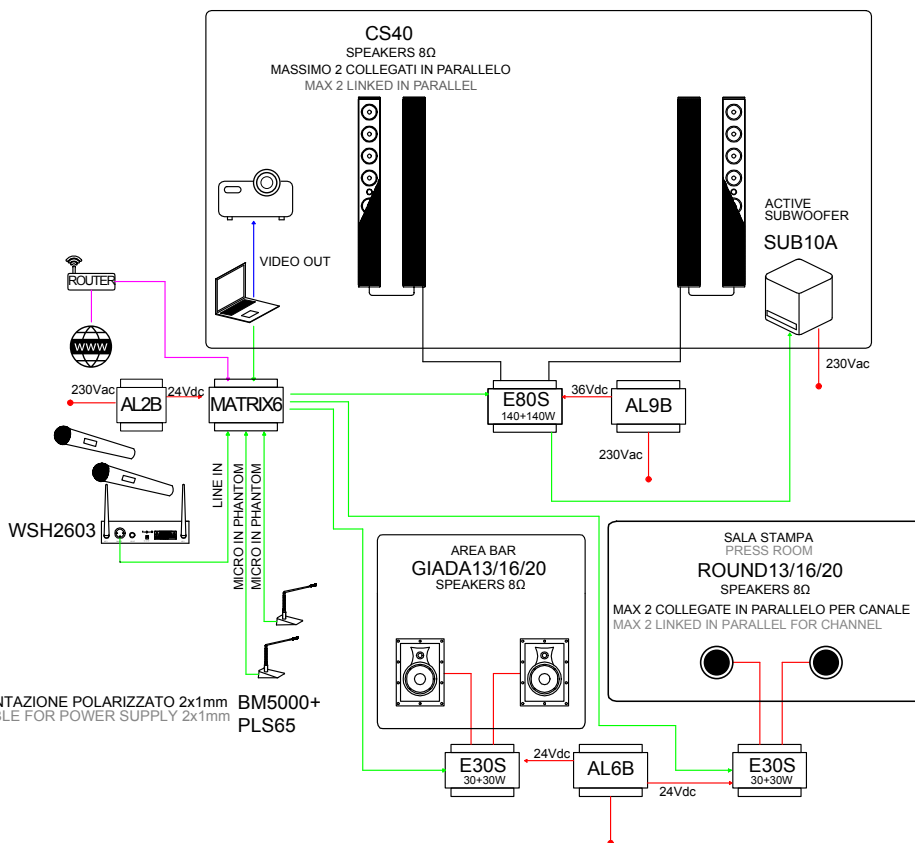

CABLE LEGEND

- CAVO DI ALIMENTAZIONE POLARIZZATO 2x1mm BM5000+ PLS65
- POLARIZED CABLE FOR POWER SUPPLY 2x1mm
- CAVO MICRO2 MICRO2 CABLE
- CAVO CAT6 CAT6 CABLE
- CAVO OTTICO OPTICAL CABLE
- CAVO HDMI HDMI CABLE

APP (iOS & ANDROID) gestione e controllo WiFi WiFi management and control

EAN13 CODE

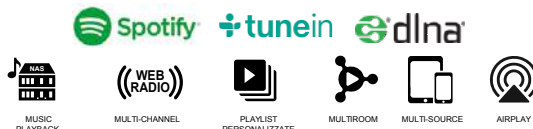

8051272188035 **P30S**



IT - Amplificatore di potenza, stereo, multicanale, domotico, con player multimediale integrato. Mixer amplificato con DSP a 4 canali mono + 1 stereo oppure 3ch stereo. Potenza amplificatore classe-D 30+30W @ 8Ω, 50+50W @ 4Ω.

APP di supervisione e controllo VIVALDI (scaricabile da iOS & Android).

API disponibili:

- KNXnet-IP (KNX IP Router necessario non di nostra fornitura)
- Protocollo MQTT 3.1 (tramite Broker esterno oppure integrato)
- REST-API (HTTP GET/POST)

4x INGRESSI MIC/LINE selezionabili con Phantom attivabile (24Vdc), priorità assegnabile (attivabile con contatto).

USB type A su frontale per riproduzione file audio MP3/WMA/AAC/AAC+/ALAC/FLAC/APE/WAV. Equalizzatore a 7 bande.

Uscita mono per subwoofer attivi.

Uscita stereo per espansioni di potenza E30S, E80S o finali di potenza Linea Vivaldi Ulisse a 8Ω o 100V.

1x RJ45 per rete LAN.

1x cavo PATCH da 1mt.

Controllo parametri audio con gestione volumi/settaggi... da webpage.

Integrabile a domotiche terze o ai dispositivi domotici multiprotocollo iCONTROL4.1L, iCONTROL4.0+ tramite rete LAN.

Alimentazione 24Vdc tramite AL5B (non in dotazione).

Standard DIN (6 moduli).

Dimensioni (LxHxP): 106x90x63 mm. Peso 0.2 Kg.

EN - Multimedia stereo device with built-in multimedia player. DSP amplified mixer with 4-channel mono + 1 stereo or 3 stereo ch.

Class-D amplifier power 30+30W @ 8Ω, 50+50W @ 4Ω.

VIVALDI supervision and control APP (downloadable from iOS & Android).

API available:

- KNXnet-IP (KNX IP mandatory Router is not provided)
- Protocollo MQTT 3.1 (through external Broker or integrated)
- REST-API (HTTP GET/POST)

4x SELECTABLE MIC/LINE INPUTS with activable Phantom (24Vdc), assignable priority (can be activated with contact).

USB Type A on the front for MP3/WMA/AAC/AAC+/ALAC/FLAC/APE/WAV audio file playback.

7-band equalizer.

Mono output for active subwoofers.

Stereo output for power expansions E30S, E80S or power amps Vivaldi Ulisse Line at 8Ω or 100V.

1x RJ45 per LAN.

1x PATCH cable 1mt.

Audio parameter control with volume/settings/... from webpage. Can be integrated with home automation systems

iCONTROL4.1L, iCONTROL4.0+ via LAN.

Power Supply 24Vdc via AL5B (not included).

DIN standard (6 modules).

Size (WxHxD): 106x90x63 mm.

Weight 0.2 Kg.

8051272188042 **P80S**



IT - Come P30S ma potenza amplificatore classe-D 80+80W @ 8Ω, 140+140W @ 4Ω.

Alimentazione 36Vdc tramite AL9B (non in dotazione). Standard DIN (6 moduli). Dimensioni 106x90x63 mm (LxHxP) Peso 0.23 Kg.

EN - Like P30S with class-D amplifier power 80+80W @ 8Ω, 140+140W @ 4Ω.

Power supply 36Vdc via AL9B (not included). DIN standard (6 modules). Size 106x90x63 mm (WxHxD) Weight 0.23 Kg.





EAN13

CODE

8051272188059 **E30S**



IT - Amplificatore stereo con DSP. Potenza amplificatore classe-D 30+30W @ 8Ω, 50+50W @ 4Ω.
Ingresso stereo bilanciato.
Uscita amplificata configurabile come segue:
- Stereo lineare con regolazione volume per singolo canale, interna con Trimmer o esterna con Potenziometri (mono TVM, stereo TVS);
- Modalità Subwoofer con regolazione frequenza di taglio e volume da Trimmer.
Uscita di linea stereo bilanciata per connessione subwoofer attivo o amplificatore ausiliario E30S, E80S; Possibilità di selezionarne il volume master o fisso. Il dispositivo può essere impostato in modalità stereo o mono dal Dip Switch a bordo.
Alimentazione 24Vdc tramite AL5B (non in dotazione).
Standard DIN (6 moduli).
Dimensioni (LxHxP): 106x90x63 mm.
Peso 0.14 Kg.

EN - DSP stereo amplifier. D - class power ampl 30+30W @ 8Ω, 50+50 @ 4Ω.
Balance stereo input.
Amplifier output customisable as below:
- Linear stereo with volume adjustment for single channel, internal with trimmer or external with potentiometers (mono TVM, stereo TVS);
- Subwoofer mode with cut frequency adjustment and trimmer volume.
- Balance stereo line output for active subwoofer connection or auxiliar amp E30S, E80S;
- Possibility to select if linked to the master volume or fixed.
- The device can be set in stereo or mono mode by the dip switch on board.
Power supply 24Vdc via Vivaldi Giove AL5B (not included)
Standard DIN (6 modules)
Size (WxHxD): 106x90x63 mm
Weight 0.14 kg.

8051272188066 **E80S**



IT - Come E30S ma potenza amplificatore classe-D 80+80W @ 8Ω, 140+140W @ 4Ω.
Alimentazione 36Vdc tramite AL9B (non in dotazione). Standard DIN (6 moduli). Dimensioni 106x90x63 mm (LxHxP) .Peso 0.14 Kg.

EN - Like E30S with class-D amplifier power 80+80W @ 8Ω, 140+140W @ 4Ω. Power supply 36Vdc via AL9B (not included). DIN standard (6 modules). Size 106x90x63 mm (WxHxD) Weight 0.14 Kg.



8051272186550 **TVM***



IT - Coppia potenziometri mono con connessioni a morsetto montati su tappo copriforo.

EN - Pair of mono potentiometers with clamp mounted on a hole cap.



8051272186567 **TVS***



IT - Potenziometro stereo con connessioni a morsetto montato su tappo copriforo.

EN - Stereo potentiometer with clamp mounted on a hole cap.

* Indicare al momento dell'ordine serie civile e colore desiderati. Cavo da utilizzare MICRO2 o MICRO4

* Please, indicate when ordering the desired civil series adapter and colour. Important: use cable MICRO2 or MICRO4

	EAN13	CODE		
	 8051272189353	AL2B nero / black	<p>IT - Alimentatore da barra DIN (2 moduli). Input 100-240 Vac 50-60Hz 0,80A. Output 24 Vdc 1,25A. 30W. Dimensioni 34x57x90 mm (LxHxP) Peso 0,18 Kg.</p>	<p>EN - DIN rail power supply (2 modules). Input 100-240 Vac 50-60Hz 0.80A. Output 24 Vdc 1.25A. 30W. Size 34x57x90 mm(WxHxD). Weight 0,18 Kg.</p>
	 8051272189360	AL3B nero / black	<p>IT - Alimentatore da barra DIN (4,5 moduli). Input 100-240 Vac 50-60Hz 1,8A. Output 24 Vdc 2,5A. Dimensioni 80x100x60 mm (LxHxP) Peso: 0,3 Kg.</p>	<p>EN - DIN rail power supply (4.5 modules). Input 100-240 Vac 50-60Hz 1.8A. Output 24 Vdc 2.5A. Size 80x100x60 mm(WxHxD) Weight: 0,3 Kg.</p>
	 8051272189377	AL5B nero / black	<p>IT - Alimentatore da barra DIN (7,5 moduli) Input 100-240 Vac 50Hz 1,2A. Output 24 Vdc 4,16A, 100W. Dimensioni 138x88x65 mm (LxHxP). Peso 0,33 Kg.</p>	<p>EN - DIN rail power supply (7.5 modules) Input 100-240 Vac 50Hz 1.2A. Output 24 Vdc 4.16A, 100W. Size 138x88x65 mm (WxHxD). Weight 0,33 Kg.</p>
	 8051272189803	AL6B nero / black	<p>IT - Alimentatore da barra DIN (6 moduli) Input 100-240 Vac 50Hz 1,8A Output 24 Vdc 6,25A, 150W Dimensioni 103x58x90 mm (LxHxP) Peso 0,35 Kg.</p>	<p>EN - DIN rail power supply (6 modules) Input 100-240 Vac 50Hz 1,8A Output 24 Vdc 6.25A, 150W Size 103x58x90 mm (WxHxD) Weight 0,35 Kg.</p>
	 8051272189810	AL7B nero / black	<p>IT - Alimentatore da barra DIN Input 100-240 Vac 50/60Hz 2,8A Output 24 Vdc 10A, 240W Dimensioni 65x126x110 mm (LxHxP) Peso 1,1 Kg.</p>	<p>EN - DIN rail power supply. Input 100-240 Vac 50/60Hz 2,8A. Output 24 Vdc 10A, 240W. Size 65x126x110 mm (WxHxD). Weight 1,1 Kg.</p>
	 8051272189827	AL9B nero / black	<p>IT - Alimentatore da barra DIN (6 moduli) Input 100-240 Vac 50Hz 1,8A Output 36 Vdc 4,17A, 150W Dimensioni 103x58x90 mm (LxHxP) Peso 0,35 Kg.</p>	<p>EN - DIN rail power supply (6 modules) Input 100-240 Vac 50Hz 1,8A Output 36 Vdc 4.17A, 150W Size 103x58x90 mm (WxHxD) Weight 0,35 Kg.</p>
	 8051272189834	AL10B nero / black	<p>IT - Alimentatore da barra DIN Input 100-240 Vac 50/60Hz 2,8A Output 36 Vdc 6,6A, 240W Dimensioni 65x126x110 mm (LxHxP) Peso 1,1 Kg.</p>	<p>EN - DIN rail power supply Input 100-240 Vac 50/60Hz 2,8A Output 36 Vdc 6.6A, 240W Size 65x126x110mm(WxHxD) Weight 1,1 Kg.</p>
	8051272180312	AL203	<p>IT - Alimentatore ventilato. Input 180-264 Vac 50-60Hz 9,7A, 350W. Output 36 Vdc 9,7A. Dimensioni 215x115x50 mm (LxHxP). Peso 1 Kg.</p>	<p>EN - Ventilated power supply. Input 180-264 Vac 50-60Hz 9.7A, 350W. Output 36 Vdc 9.7A. Size 215x115x50 mm (WxHxD). Weight 1 Kg.</p>



AREA COMMERCIALE - SALES AREA

VIVALDI

INVISIBLE65 SPEAKERS 8Ω

MAX 2 COLLEGATE IN PARALLELO PER CANALE
MAX 2 LINKED IN PARALLEL FOR CHANNEL

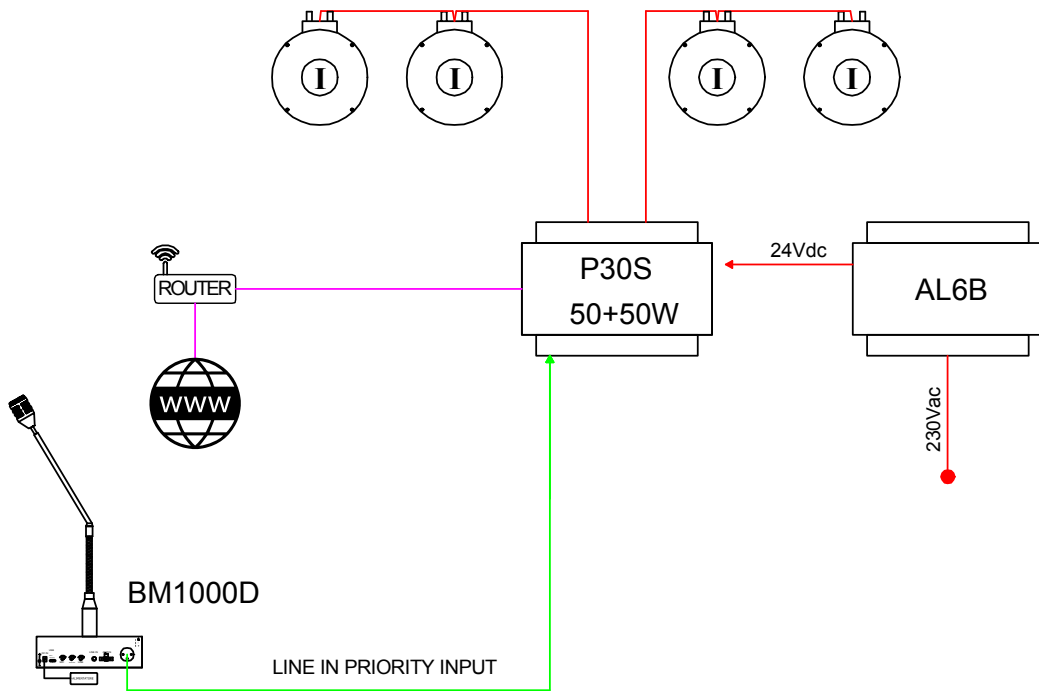

3 ZONE CON PLAYER PER MUSICA INDIPENDENTE O SINCRONIZZATA 3 ZONES WITH AUDIO PLAYER FOR INDEPENDENT OR SYNCHRONIZED MUSIC Il sistema può essere ampliato in più zone - The system can be expanded in several zones

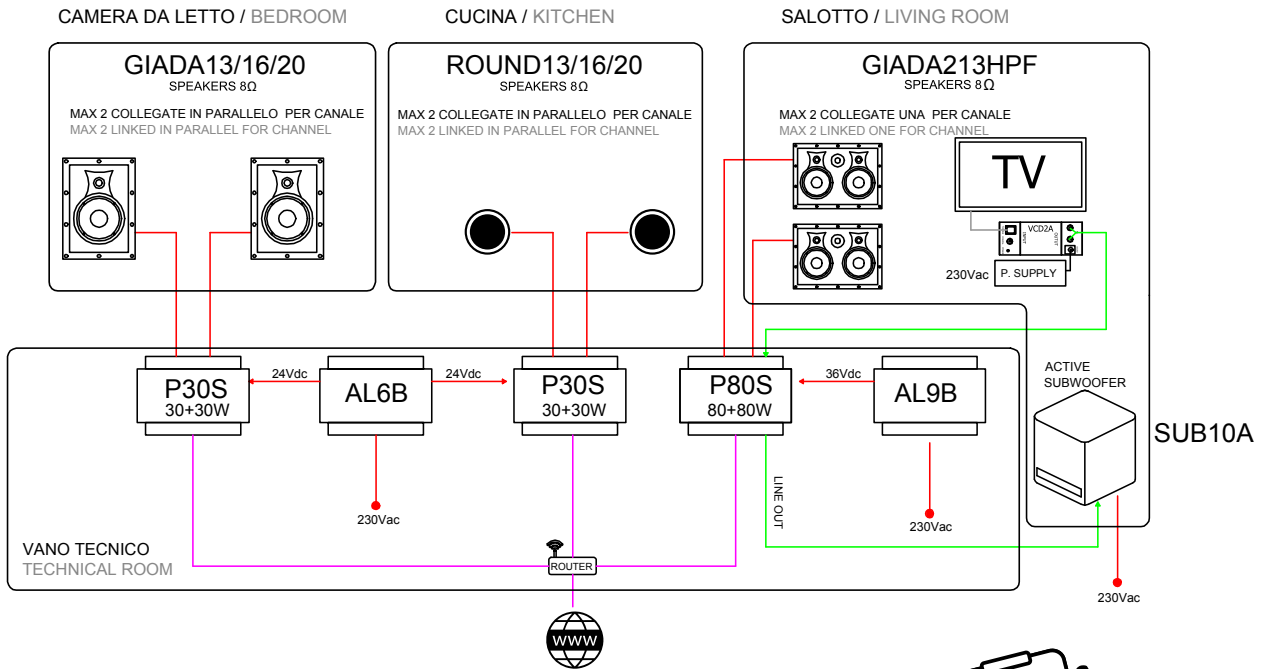

CABLE LEGEND

- CAVO DI ALIMENTAZIONE POLARIZZATO 2x1mm
POLARIZED CABLE FOR POWER SUPPLY 2x1mm
- CAVO MICRO2
MICRO2 CABLE
- CAVO CAT6
CAT6 CABLE
- CAVO OTTICO
OPTICAL CABLE



APP (iOS & ANDROID)
gestione e controllo WiFi
WiFi management and control



Bluetooth music

Hotel room b&b offices





EAN13

CODE



8051272189773

A25SBTC



8051272189995

PBT prolunga antenna Bluetooth/extension



PBT

Prolunga antenna Bluetooth da usare oltre i 10mt di portata dell'antenna interna.
Bluetooth antenna extension to be used over 10mt A25SBTC internal antenna range.



IT - Amplificatore di potenza 25+25W RMS, stereo, con ingresso audio analogico e sorgente Bluetooth integrata.

Fornito con PIN standard o personalizzato (codice PIN programmato in fabbrica: nome max 30 caratteri, password max 4 numeri) da comunicare in fase d'ordine.
Funzione mono/stereo selezionabile da DIP switch.
Selezione modalità controllo volume da DIP switch. Volume interno (trimmer) o potenziometri esterni (mono TVM, stereo TVS).
La sorgente bluetooth integrata ha priorità sul segnale proveniente dall'ingresso.
Regolazione sensibilità rilevatore audio integrato.
LED DI STATO:
blu: bluetooth attivo
verde: presenza di segnale musicale
rosso: accensione
PULSANTI: play, pausa
DATI TECNICI:
1x morsetto Ingresso audio locale (stereo) e alimentazione 24Vdc.
1x morsetto connessione speaker 25W @ 4-8Ω per canale (impedenza minima 4Ω/canale).
2x morsetti connessione potenziometro remoto esterno.
1x connettore SMA per antenna bluetooth esterne (se installato non in stanza, ma in un vano tecnico).
Controllo di sensibilità ingresso a seconda del tipo di sorgente esterna.
Alimentazione tramite AL3B (da ordinare a parte).
Corrente 1,2A.
Dimensioni 54x90x63 (3 Moduli) mm (LxHxP).
Peso 0.10 Kg.

EN - 25+25W RMS power stereo amplifier, with analog audio input and integrated Bluetooth source.

Included with standard or custom PIN (PIN code programmed at the factory: name max 30 characters, password max 4 numbers) to be communicated when ordering.
Mono/stereo function selectable from DIP switch.
Select volume control mode from DIP switch. Internal volume (trimmer) or external potentiometers (mono TVM, TVS stereo).
The built-in bluetooth source takes priority over the signal coming from the input.
Built-in audio detector sensitivity adjustment.
STATUS LED:
Blue: Bluetooth Active
green: presence of music signal
Red: Ignition
BUTTONS: play, pause
TECHNICAL DATA:
1x Clamp Local audio input (stereo) and 24Vdc power supply.
1x speaker connection terminal 25W @ 4-8Ω per channel (minimum impedance 4Ω/channel).
2x external remote potentiometer connection terminals.
1x SMA connector for external bluetooth antenna (if installed not in the room, but in a technical compartment).
Input sensitivity control depending on the type of external source.
Power supply via AL3B (not included).
Current 1.2A.
Size 54x90x63 (3 Modules) mm (WxHxD).
Weight 0.10 Kg.

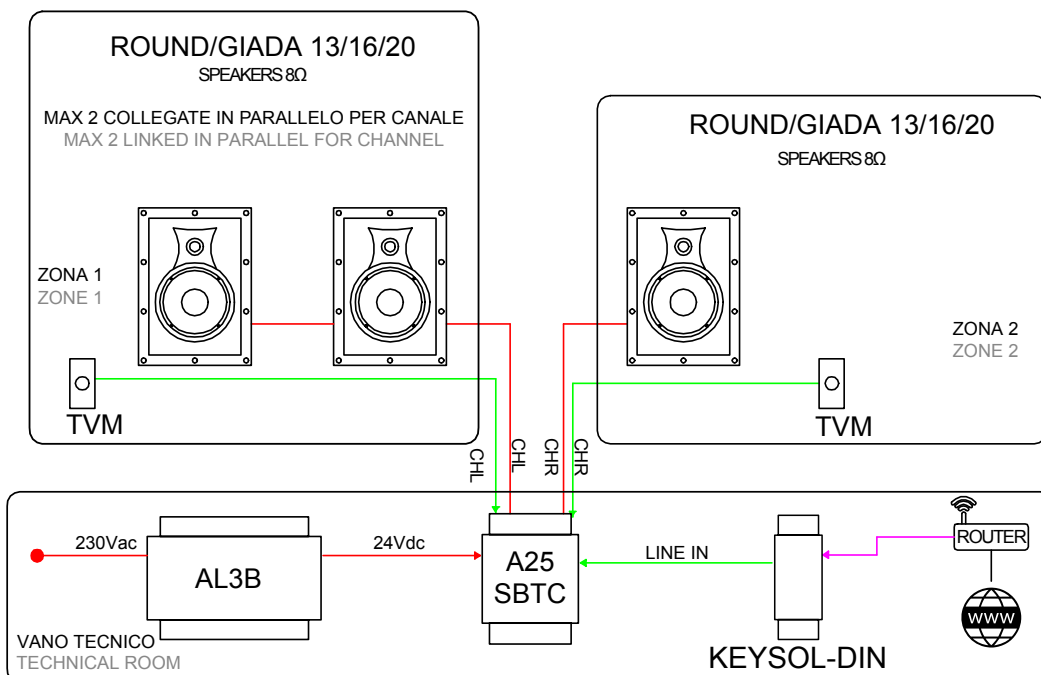

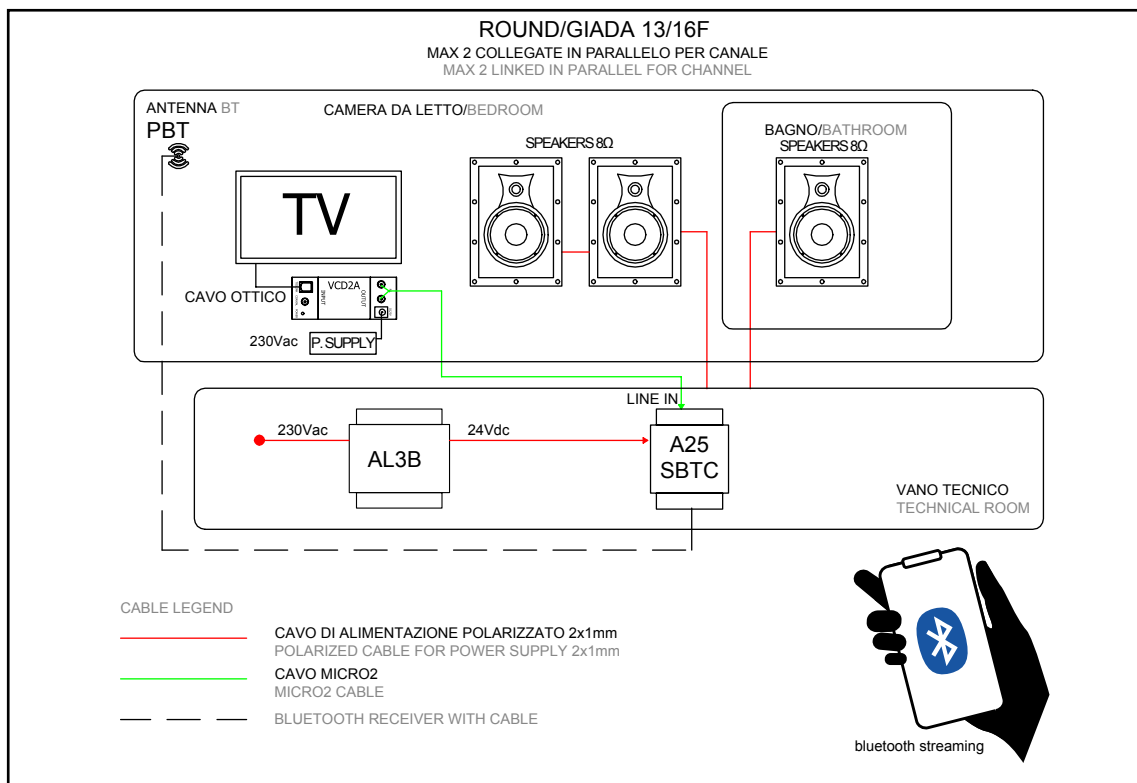

EAN13 CODE



8051272186550 TVM*

IT - Coppia potenziometri mono con connessioni a morsetto montati su tappo copriforo.

EN - Pair of mono potentiometers with clamp mounted on a hole cap.



8051272186567 TVS*

IT - Potenziometro stereo con connessioni a morsetto montato su tappo copriforo.

EN - Stereo potentiometer with clamp mounted on a hole cap.



8051272189360 AL3B nero / black

IT - Alimentatore da barra DIN (4,5 moduli). Input 100-240 Vac 50-60Hz 1,8A. Output 24 Vdc 2,5A. Colore nero. Dimensioni 80x100x60 mm (LxHxP). Peso 0,3 Kg.

EN - DIN bar power supply (4.5 modules). Input 100-240 Vac 50-60Hz 1.8A. Output 24 Vdc 2.5A. Black color. Size 80x100x60 mm (WxHxD). Weight 0,3 Kg.



8051272189377 AL5B nero / black

IT - Alimentatore da barra DIN (7,5 moduli) Input 100-240 Vac 50Hz 1,2A. Output 24 Vdc 4,16A, 100W. Colore nero. Dimensioni 138x88x65 mm (LxHxP).Peso 0,33 Kg.

EN - DIN rail power supply(7.5 modules) Input 100-240 Vac 50Hz 1.2A. Output 24 Vdc 4.16A, 100W. Size 138x88x65 mm (WxHxD). Weight 0,33 Kg.



8051272183535 AL8

IT - Alimentatore da barra DIN (4 moduli, installazione da retro quadro). Input 100-240 Vac 50-60Hz 3,3A. Output 24 Vdc 5A. Dimensioni 65x126x110 mm (LxHxP). Peso 1,1 Kg.

EN - DIN bar power supply (4 modules, installation from back panel). Input 100-240 Vac 50-60Hz 3.3A. Output 24 Vdc 5A. Size 65x126x110 mm (WxHxD). Weight 1,1 Kg.

* Indicare al momento dell'ordine serie civile e colore desiderati. Cavo da utilizzare MICRO2 o MICRO4
 * Please, indicate when ordering the desired civil series adapter and colour. Important: use cable MICRO2 or MICRO4



Smart
multimedia

Home &
automation building



EAN13

CODE



8051272187366 | **FREECONTROL**

IT - Dispositivo di supervisione e controllo per FREEMK3, FREELIGHT.
Funzione di ricerca dispositivi.
10 scenari registrabili a piacere.
Dimensioni (LxHxP) 54x90x63 mm
Alimentatore AL2B da ordinare a parte.

EN - Supervision and control device for FREEMK3, FREELIGHT.
Auto-setting.
10 scenarios that can be recorded as desired.
Size (WxHxD) 54x90x63 mm.
AL2B Power supply not included.



8051272187359 | **iCONTROL4.1L**



IT - Dispositivo di supervisione e controllo per FREENETMK3, FREESOURCEMK3, iFREEMK3.55, iFREEMK3.70, Universal Gateway, video 4K.
Dimensioni (LxHxP) 54x90x63 mm.
Alimentatore AL2B fornito in dotazione.

EN - Supervision and control device for FREENETMK3, FREESOURCEMK3, iFREEMK3.55, iFREEMK3.70, Universal Gateway, 4K video devices.
Size (WxHxD) 54x90x63 mm.
AL2B Power supply included.



8051272184112 | **iCONTROL4.0UPG**

Upgrade licenza da iCONTROL4.1L ad iCONTROL4.0+.

EN - License upgrade from iCONTROL4.1L to iCONTROL4.0+.

8051272185423 | **MY6**

on demand

Configurazione personalizzata dei supervisori iCONTROL ed EVO.VISION

EN - Custom configuration of iCONTROL supervisors and EVO.VISION

8051272187342 | **EVO.VISION**



IT - Dispositivo di supervisione e controllo per centrali Vivaldi di evacuazione vocale EN54 e FREESOURCEMK3.
Dimensioni (LxHxP) 54x90x63 mm.
Alimentatore AL2B da ordinare a parte.

EN - Supervision and control device for Vivaldi EN54 voice evacuation control panels and FREESOURCEMK3.
Size (WxHxD) 54x90x63 mm.
AL2B Power supply not included.





supervisione e controllo tramite APP
supervision and control via APP

VIVALDI

EAN13

CODE

8051272182774 **iCONTROL4.0+**



IT - Dispositivo di supervisione e controllo multiprotocollo per la gestione degli impianti Domotici, Audio, Video, Vivaldi e dei protocolli più diffusi (KNX, IESS, Vimar By-Me, BTicino Legrand, Ave Domina Plus, ModBus RTU, ...).

Illimitato numero di dispositivi integrabili.
Più di 500 accessi in contemporanea.
Licenza d'uso senza scadenza.
Dimensioni (LxHxP) 106x90x63 mm.
Alimentatore AL2B fornito in dotazione.

EN - Multiprotocol supervision and control device for management of Home Automation, Audio, Video, Vivaldi systems and the most popular protocols (KNX, IESS, Vimar By-Me, BTicino Legrand, Ave Domina Plus, ModBus RTU, ...). Unlimited number of integrable devices.
More than 500 accesses at the same time.
License of use without expiration.
Size (WxHxD) 106x90x63 mm.
AL2B Power supply included.



*tramite programmazione specifica (MY6)
*through specific programming (MY6)



JPG / MJPG // H264
H265 / RTSP / HTTP





EAN13

CODE



8051272187335 | **EVO.BRIDGE**



IT - Dispositivo di comunicazione tra dispositivi EVAC e protocollo ModBus RTU.
Configurazione indirizzo ModBus tramite DipSwitch frontale.
Diagnostica a LED della comunicazione Modbus e LINK.
Allarme sonoro in caso di mancata comunicazione o connessione LINK di EVAC.
PROTOCOLLI GESTITI:
- EVAC (RJ45 LINK)
- ModBus RTU (Supervisione)
CONNESSIONI:
- 1x RS485 (ModBus RTU)
- 1x RJ45 (EVAC LINK)
- 1x Alimentazione 12-24 VDC
Dimensione: 36x90x63 mm (LxHxP)
2 moduli barra DIN
Alimentazione: 12-24 Vdc (tramite AL2B, fornito in dotazione)

EN - Communication device between EVAC equipment and ModBus RTU protocol.
ModBus address configuration via front DipSwitch.
LED diagnostics of Modbus and LINK communication.
Audible alarm in case of non-communication or EVAC LINK connection.
PROTOCOLS MANAGED:
- EVAC (RJ45 LINK)
- ModBus RTU (Supervision)
CONNECTIONS:
- 1x RS485 (ModBus RTU)
- 1x RJ45 (EVAC LINK)
- 1x Power supply 12-24 VDC
Size: 36x90x63 mm (WxHxD)
2 DIN rail modules
Power supply: 12-24 Vdc (via AL2B, included)

8051272185416 | **MUSICO** versione 1.079 del 240521



IT - MEDIACENTER AUDIO. SORGENTE MULTIMEDIALE PER SISTEMA VIVALDI.
Utilizza MUSICO su qualsiasi browser o tramite iCONTROL4.1L, iCONTROL4.0+ . **MUSICO è un vero riproduttore musicale digitale HI-FI: un sistema audio di alta qualità progettato appositamente per offrire riproduzione Bit-perfect, e qualità audio senza compromessi.**
Le possibilità sono infinite.
Un DAP (Digital Audio Player) per tutta la tua musica: MP3, FLAC, AAC, ALAC, DSD, e molti altri. Inoltre avrai a disposizione UPNP DLNA, Airplay, Spotify e Web Radio tutto in un singolo dispositivo, e potrai sincronizzare la musica da ciascuna zona.
Rete: 1xRJ45, WiFi. Ingressi Audio: 1x Audio analogico
Uscite Audio: 1x Audio analogico, 2x Audio analogico bilanciato
Sorgenti locali: 4x USB
Formati audio: FLAC, Alac, Aac, Vorbis, Mp3, DSD ecc...
Supporta: DLNA/UPNP
Streaming audio Bluetooth
Web Radio integrate
Spotify Connect, HIGHRESAUDIO, Tidal e Qobuz, per lo streaming di musica, podcast.
Funzione Airplay integrata per ascoltare tutto ciò che vuoi dal tuo dispositivo Apple (es. Youtube)
Gestione archivi di rete CIFS e NFS con funzione auto discovery
Supporto multilingua
Sfondo personalizzabile
Funzioni sveglia e sleep
Funzione multiroom
Alimentazione: Jack o morsetto estraibile 12/24V Max.10W (a seconda delle periferiche USB connesse)
Alimentatore AL2B fornito in dotazione
Dimensioni 105x33x90 mm (LxHxP)
Peso 0.6 Kg

EN - MEDIACENTER AUDIO. MULTIMEDIA SOURCE FOR VIVALDI SYSTEM.
Use MUSICO on any browser or via iCONTROL4.1L, iCONTROL4.0+ . **MUSICO is a true HI-FI digital music player: a high-quality audio system designed specifically to offer Bit-perfect playback, and uncompromising audio quality.**
The possibilities are endless.
A DAP (Digital Audio Player) for all your music: MP3, FLAC, AAC, ALAC, DSD, and many more. Moreover, you'll have UPNP DLNA, Airplay, Spotify, and Web Radio all in one device, and you can sync music from each zone.
Network: 1xRJ45, WiFi. Audio Inputs: 1x Analog Audio
Audio Outputs: 1x Analog audio, 2x balanced analog audio
Local sources: 4x USB
Audio formats: FLAC, Alac, Aac, Vorbis, Mp3, DSD etc...
Supports: DLNA/UPNP
Streaming audio Bluetooth
Integrated Web Radios
Spotify Connect, HIGHRESAUDIO, Tidal and Qobuz, for streaming music, podcasts.
Airplay function enables to listen anything you want from your Apple device (eg. Youtube)
CIFS and NFS network archive management with auto discovery function
Multi-language support
Customizable background
Alarm clock and sleep functions
Multiroom function
Power supply: Jack or removable clamp 12/24V Max.10W (depending on the USB connected)
AL2B power supply included
Size 105x33x90 mm (WxHxD)
Weight 0.6 Kg

alcune screnn / some screens

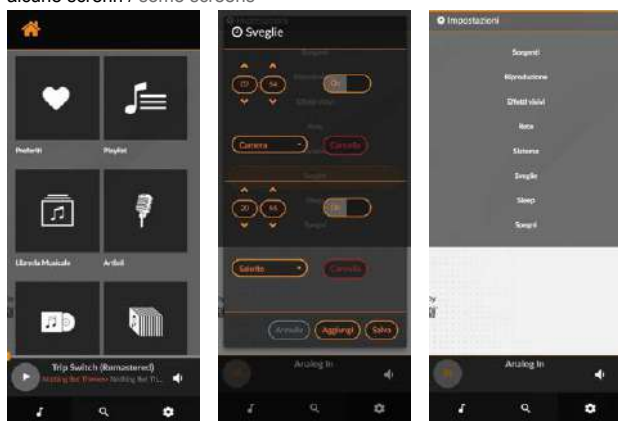



EAN13

CODE



MUSICOUPG

IT - Upgrade del MUSICO per versioni precedenti alla 1.079 del 240521

EN - Upgrade of the MUSICO for preceding versions to 1.079 of the 240521

8051272187038 MOD4i



IT - Interfaccia 4 ingressi ModBus per pulsanti tradizionali. Installazione su scatola di derivazione. Dimensioni (LxHxP) 43x59x19 mm. Peso 0,15 Kg. Colore nero.

EN - Interface 4 ModBus inputs for traditional buttons. Installation on junction box. Size (WxHxD) 43x59x19 mm. Weight 0,15 Kg. Black color.

8051272181401 AC5



IT - Dispositivo per la gestione remota di 5 contatti (5A Max) Contatti in deviazione NC/NO su morsetti europlug 3 vie Collegamento Ethernet 10/100 tramite porta RJ45 Configurazione attraverso web server integrato Possibilità di espansione fino ad un massimo di 5 apparecchi in cascata (via RS485), per un totale di 25 contatti. Possibilità d'installazione su guida DIN. Tensione di alimentazione 12/24Vdc. Assorbimento MAX 200mA Dimensioni (LxHxP) 90x72x60 mm Peso 0,2 Kg Predisposizione guida DIN 4 moduli

EN - Device for remote management of 5 contacts (5A Max) NC/NO deviation contacts on 3 way europlug terminals Ethernet connection 10/100 via RJ45 port Configuration through integrated web server Possibility of expansion up to a maximum of 5 devices in daisy chain (via RS485), for a total of 25 contacts Possibility of installation on DIN rail Power supply 12/24Vdc Absorption MAX 200mA Size (WxHxD) 90x72x60 mm Weight 0,2 Kg DIN rail predisposition 4 modules

8051272183849 DRIVERLED



IT - Driver led 3 canali, MAX. 5A/CH. Tipo di uscita: open-drain, positivo comune Alimentazione 12:24Vdc Potenza: 60VA/CH Alimentazione 12Vdc, 120VA/CH, 24Vdc Tipo di controllo: Modbus RTU su RS485 Dimensioni (LxHxP) 90x54x60 mm Peso 0,4 Kg

EN - Driver led 3 channels, MAX. 5A/CH. Output Type: Open-drain, Common Positive Power Supply 12:24Vdc Power: 60VA/CH Power supply 12Vdc, 120VA/CH, 24Vdc Control type: Modbus RTU on RS485 Size (WxHxD) 90x54x60 mm Weight 0,4 Kg



8051272189872 GATEWAYKNX



IT - Gateway tra lo standard mondiale KNX per la home & building automation ed il protocollo di comunicazione VIVANET. 1x Alimentazione 1x Connessione KNX 1x Bus VivaNET Supporta Fino ad un massimo di 16 dispositivi Giove Free. Dimensione (LxHxP) 36x90x63mm Standard DIN (2 moduli) Alimentazione 12-24Vdc Consumo massimo 150mA

EN - Gateway between the KNX world standard for home & building automation and VIVANET protocol used by Vivaldi devices. 1x Power supply 1x KNX connection 1x VivaNET Bus Supports Up to a maximum of 16 Giove Free devices. Size (WxHxD) 36x90x63mm DIN standard (2 modules) Power supply 12-24Vdc Maximum consumption 150mA



	FREECONTROL	iCONTROL4.1L
Descrizione Description	supervisione e controllo tramite la rete WiFi/LAN per FREEMK3 e FREELIGHT monitoring and control via WiFi/LAN network for FREEMK3 and FREELIGHT	supervisione e controllo tramite la rete WiFi/LAN per sistemi MULTIMEDIALI AUDIO VIDEO LUCI, CINEMA, SALE MEETING monitoring and control via WiFi/LAN network for multimedia systems audio, video, lights, cinema, meeting rooms
Compatibilità comandi Controls compatibility	FREEMK3, FREELIGHT	FREENETMK3, FREESOURCEMK3, iFREEMK3
Nr. comandi massimi gestiti Maximum nr. of managed controls	32	32 (per ciascuna porta RS485) 32 (for each RS485 port)
Compatibilità centrali Main units compatibility	CA48	CA48
Compatibilità domotica Domotics compatibility	---	si / yes (UDP DATAGRAM, MODBUS RTU)
Upgrade	---	si, ad iCONTROL4.0+ tramite iCONTROL4.0UPG yes, to iCONTROL4.0+ with iCONTROL4.0UPG
Principali funzioni Main functions	supervisione e controllo comandi di zona chiamate microfoniche selettive o generali tramite PM2 10 scenari registrabili accensione e spegnimento con timer scheduler interno per scenari management and control of zones devices selective or general (via PM2) paging messages 10 recordable macro on-off with timer internal scheduler for macro	supervisione e controllo comandi di zona matrici audio, video, MUSICO, AC5, sintoamplificatori, blu-ray... gestione chiamate microfoniche indirizzate chiamate microfoniche selettive o generali tramite PM2 management and control of zones devices audio matrix, video, MUSICO, AC5, sintoamplifier, blu-ray selective or general (via PM2) paging messages
Altre funzioni tramite programmazione custom Further functions via custom programming	---	timer per accensioni e spegnimenti programmati. 10 scenari registrabili. Scheduler interno per programmazione timer degli scenari. Configurazione liberamente modificabile tramite software iCONTROL MANAGER disponibile per PC WIN/MAC sul sito Vivaldi. timer for scheduled on and off. 10 recordable scenarios. Internal scheduler for scenario timer programming. Configuration freely editable through iCONTROL MANAGER software available for PC WIN/MAC on Vivaldi website.
Controllo in rete Network control	locale, remoto (necessario IP pubblico) local, remote (public IP is necessary)	locale, remoto (necessario IP pubblico) local, remote (public IP is necessary)
Controlli vocali Voice control	---	si / yes Google/Amazon Alexa
Programmazione custom Custom programming	---	si / yes
Grafici statistici Statistical graphs	---	---
Info meteo	---	si / yes
Software di programmazione Programming software	---	si, scaricabile da Vivaldigroup.it yes, downloadable from Vivaldigroup.it
Autoindirizzamento zone Zone auto-addressing	si / yes	si / yes
Creazione scenari Scenario creation	si (in modalità scenari utente) yes (in User Scenarios mode)	si / yes
Nr. scenari configurabili Nr. of customizable scenarios	10 (registrabili) 10 (recordable)	illimitati / unlimited
Protocolli integrati Integrated protocols	FREEMK3, FREELIGHT	FREENETMK3, FREESOURCEMK3, iFREEMK3, UDP Datagram MODBUS RTU



iCONTROL4.0+	EVO.VISION
supervisione e controllo tramite la rete WiFi/LAN per sistemi DOMOTICI, MULTIMEDIALI, AUDIO VIDEO LUCI, CINEMA, SALE MEETING monitoring and control via WiFi/LAN network for domotic and multimedia systems, audio, video, lights, cinema, meeting rooms	supervisione e controllo per sistemi di evacuazione vocale EN54 MULTIMEDIALI Monitoring and control system for EN54 vocal evacuation multimedia systems
FREENETMK3, FREESOURCEMK3, iFREETMK3	FREESOURCEMK3
32 (per ciascuna porta RS485) / 32 (for each RS485 port)	32 (per ciascuna porta RS485) / 32 (for each RS485 port)
CA48	EVO500 2/4/6, EVO500M 2/4/6, EVO1000M 4/6, EVO+
si / yes (KNX, MODBUS RTU, VIMAR, BTICINO, AVE, IESS)	---
---	---
supervisione e controllo dei sistemi domotici KNX, MODBUS RTU, VIMAR, BTICINO, AVE, IESS supervisione e controllo comandi di zona matrici audio e video, MUSICO, AC5, sintoamplificatori, blu-ray... gestione chiamate microfoniche indirizzate chiamate microfoniche selettive o generali tramite PM2 management and control of domotic systems KNX, MODBUS RTU, VIMAR, BTICINO, AVE, IESS management and control of zones devices audio video matrix, MUSICO, AC5, sintoamplifier, blu-ray selective or general (via PM2) paging messages	supervisione e controllo delle sorgenti compatte di zona, delle centrali EVAC EN54 ricezione feedback sullo stato impianto attraverso EVO.BRIDGE (ModBus RTU) gestione ed invio notifiche mail o push sullo stato impianto, anomalie e guasti integrazione dispositivi con Web Page management and control of zones compact sources management and control of EVAC EN54 CENTRAL UNITS feedback on the system status via EVO.BRIDGE (Modbus RTU) management and notification sending (mail or push) about system status, anomalies and failures devices integration via Web Page
inserimento web interface di altri dispositivi (es. GRM1, MUSICO) controllo matrici video HDMI* interfacce grafiche personalizzabili* fornire info Meteo ai dispositivi FREENETMK3* fornire info di temperatura e umidità della stanza provenienti da una domotica esterna* gestione cronotermostato, climatizzazione, prese comandate, telecamere IP, gestione eventi, scenari virtuali, statistiche di consumo, messaggi di allarme, irrigazione, notifiche mail o notifiche push, crepuscolare astronomico, stazione Meteo web, ... tramite programmazione specifica web insertion interfaces of other devices (e.g. GRM1, MUSICO) HDMI video matrix control* customizable graphical interfaces* provide Weather info to FREENETMK3* devices provide information on the temperature and humidity of the room coming from an external home automation* chronothermostat management, air conditioning, controlled sockets, IP cameras, event management, virtual scenarios, consumption statistics, alarm messages, irrigation, mail notifications or push notifications, astronomical twilight, web weather station, ... through specific programming	supervisione impianti EN54, invio notifiche guasti. Esempio di azioni su dispositivi tecnologici FREESOURCEMK3: accensione/spengimento, regolazione volume, toni, cambio frequenza Tuner FM, cambio sorgente, cambio Traccia/Album lettore USB integrato nel FREESOURCEMK3, gestione chiamate microfoniche selettive, autoricerca dei comandi di zona FREESOURCEMK3 installati nell'impianto con creazione automatica di un'interfaccia base, interfacce grafiche personalizzabili Supervision of EN54 systems, sending fault notifications. Example of actions on FREESOURCEMK3 technological devices: on/off, volume adjustment, tones, FM Tuner frequency change, source change, Track/Album change USB player integrated in the FREESOURCEMK3, management of selective microphone calls, self-search of FREESOURCEMK3 zone commands installed in the system with creation automatic of a basic interface, customizable graphical interfaces
locale, remoto (necessario IP pubblico) local, remote (public IP is necessary)	locale, remoto (necessario IP pubblico) local, remote (public IP is necessary)
si / yes Google/Amazon Alexa	---
si / yes	si / yes
si, personalizzabili / yes, customizable	si, personalizzabili / yes, customizable
si / yes	no
si, scaricabile da Vivaldigroup.it yes, downloadable from Vivaldigroup.it	si, scaricabile da Vivaldigroup.it yes, downloadable from Vivaldigroup.it
si / yes	si / yes
si / yes	si / yes
illimitati / unlimited	illimitati / unlimited
FREENETMK3, FREESOURCEMK3, iFREETMK3, -21, PIONEER, UDP Datagram, KNX, IESS, MODBUS RTU, VIMAR BY-ME, BTICINO LEGRAND, AVE DOMINA PLUS	FREESOURCEMK3, MODBUS (EVO.BRIDGE)



	FREECONTROL	iCONTROL4.1L
Dispositivi integrabili Integrable devices	---	si, es. matrici video Vivaldi ed accessori yes, exp.Vivaldi Video matrices and accessories
Connessioni Connections	2x RS485 1x RJ45 (LAN 10/100) 1x Alimentazione / Power supply 12-24 VDC	2x RS485 1x RJ45 (LAN 10/100) 1x Alimentazione / Power supply 12-24 VDC
Accessori / Accessories	---	MUSICO, AC5, DRIVERLED
Cavo / Cable	VG10	VG10
Licenza / License	inclusa / included	inclusa / included
Scadenza licenza / License expiration	nessuna scadenza / no expiry	nessuna scadenza / no expiry
Accessi utenti User accesses	fino a 20 anche in contemporanea up to 20 at the same time	fino a 512 anche in contemporanea / up to 512 at the same time
Personalizzazione livelli accessi utenti Customization of user access levels	---	si / yes
App di controllo gratuita / Free control App	si / yes, iCONTROL	si / yes, iCONTROL
Interfaccia grafica Graphical interface	a lista (NON personalizzabile) / list (NOT customizable)	a lista (personalizzabile) a mappe (personalizzabile) list (customizable), maps (customizable)
Dimensioni (LxHxP) mm / Size (WxHxD) mm	54x90x63	54x90x63
Standard DIN	si, 3 moduli / yes, 3 modules	si, 3 moduli / yes, 3 modules
Peso Kg / Weight Kg	0,11	0,11
Alimentazione Power supply	12-24 Vdc (alimentatore AL2B da ordinare a parte) 12-24 Vdc (AL2B not included)	12-24 Vdc (AL2B in dotazione) 12-24 Vdc (AL2B included)
Compatibilità sistemi operativi App App compatibility with operating system	iOS/Android/Windows/MacOSX	iOS/Android/Windows/MacOSX
Compatibilità sistemi operativi software Software compatibility with operating system	---	iOS/Android/Windows/MacOSX
Certificazioni / Certifications	RoHS, CE	RoHS, CE
Composizione kit Kit composition	FREECONTROL e quickstart	iCONTROL4.1L, Alimentatore (AL2B), Cavo Ethernet Cat5E da 1mt, manuale iCONTROL4.1L, Power supply (AL2B), 1mt Cat5E Ethernet cable, manual
Requisiti ambientali Environmental requirements	temperatura d'esercizio da +5 a +55°Cumidità relativa da 5% a 95% (senza condensa) operating temperature: from +5° to +55°C allowable relative humidity ranging : from 5% to 95% (non-condensing)	

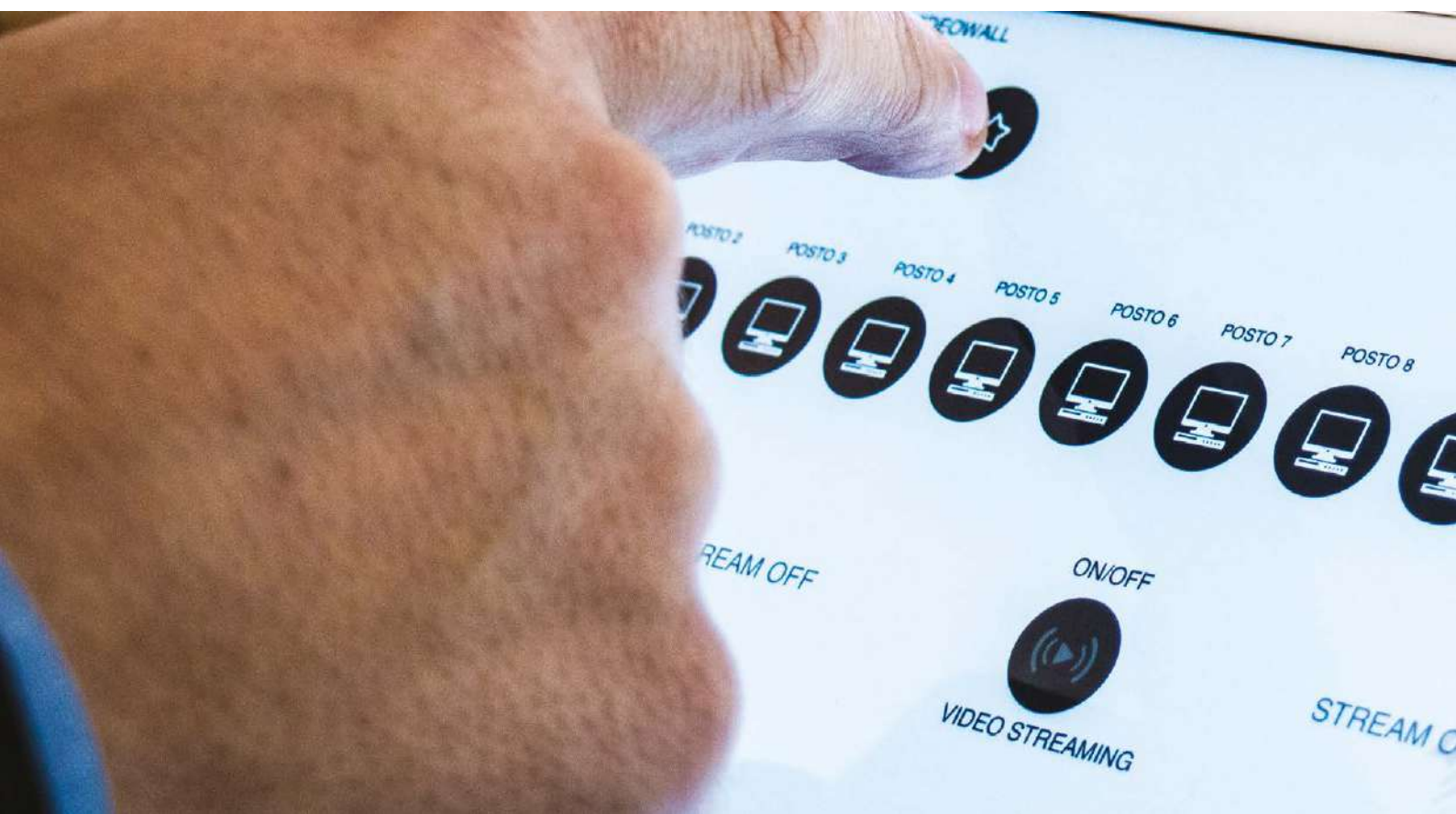



iCONTROL4.0+	EVO.VISION
si, illimitati yes, unlimited	---
Alimentazione / Power supply 24Vcc Ethernet 10/100 USB di servizio / Service USB 2x RS232 2x RS485 Porta bus / Bus port EIB/KNX	2x RS485 1x RJ45(LAN 10/100) 1x Alimentazione / Power supply 12-24 VDC 1x Ethernet 10/100 1x USB di servizio / Service USB
MUSICO, AC5, DRIVERLED	EVO.BRIDGE, MUSICO
VG10	VG10
inclusa / included	inclusa / included
nessuna scadenza / no expiry	nessuna scadenza / no expiry
fino a 512 anche in contemporanea / up to 512 at the same time	fino a 512 anche in contemporanea / up to 512 at the same time
si / yes	si / yes
si / yes, iCONTROL	si / yes, iCONTROL
a lista (personalizzabile) a mappe (personalizzabile) list (customizable), maps (customizable)	a lista (personalizzabile) a mappe (personalizzabile) list (customizable), maps (customizable)
106x90x63	54x90x63
si, 6 moduli / yes, 6 modules	si, 3 moduli / yes, 3 modules
0,187	0,11
24 Vdc (AL2B in dotazione) 24 Vdc (AL2B included)	12-24 Vdc (AL2B in dotazione) 12-24 Vdc (AL2B included)
iOS/Android/Windows/MacOSX	iOS/ Android/Windows/MacOSX
iOS/Android/Windows/MacOSX	iOS/ Android/Windows/MacOSX
RoHS, CE	RoHS, CE
iCONTROL4.0+, Alimentatore (AL2B), Cavo Ethernet Cat5E da 1mt, manuale iCONTROL4.0+, Power supply (AL2B), 1mt Cat5E Ethernet cable, manual	EVO.VISION, Alimentatore (AL2B), Cavo Ethernet Cat5E da 1mt, manuale EVO.VISION, Power supply (AL2B), 1mt Cat5E Ethernet cable, manual
temperatura d'esercizio da +5 a +55°C umidità relativa da 5% a 95% (senza condensa) operating temperature: from +5° to +55°C allowable relative humidity ranging : from 5% to 95% (non-condensing)	





Multiroom

systems

Audio video
multimedia

HiFi &
home cinema



EAN13 **CODE**

	8051272189513	FREELIGHT.B antracite / anthracite
	8051272189520	FREELIGHT.S silver
	8051272189537	FREELIGHT.SABBIA sand
	8051272189544	FREELIGHT.W bianco / white



IT - Dispositivo multimediale compatto per 503 Made in Italy, HiFi Stereo, 25W+25W RMS (50+50W musicali) con Bluetooth, USB, 2 ingressi ausiliari, uscite PRE per subwoofer/diffusori ATTIVI/espansioni. APP di controllo FREECONTROL da ordinare a parte. Alimentazione tramite alimentatore da ordinare a parte: AL3B fino a 2 diffusori AL5B fino a 4 diffusori

EN - Compact multimedia device for box 503 Made in Italy, HiFi Stereo, 25W+25W RMS (50+50W music) with Bluetooth, USB, 2 auxiliary inputs, PRE outputs for subwoofers/ACTIVE speakers/expansions. FREECONTROL control APP not included. Power supply not included: AL3B up to 2 speakers AL5B up to 4 speakers

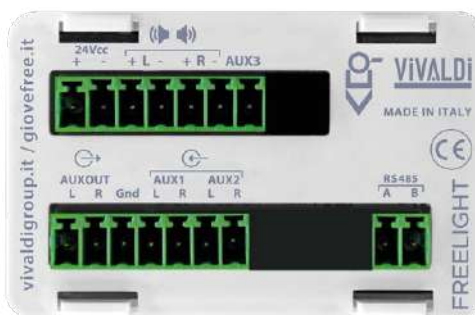

ordinare l'adattatore per la serie civile desiderata (vedi pag. 54-55)
order the adapter for the desired civil series (see p. 54-55)

8051272188158	FREEMK3.B antracite / anthracite
8051272188172	FREEMK3.S silver
8051272188400	FREEMK3.SABBIA sand
8051272188165	FREEMK3.W bianco / white

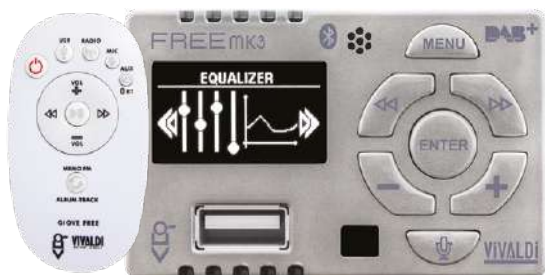

IT - Dispositivo multimediale compatto per 503 Made in Italy, HiFi Stereo, 25W+25W RMS (50+50W musicali) con Bluetooth, USB, Radio FM, Radio DAB+, Microfono, 2 ingressi ausiliari, uscite PRE per subwoofer/diffusori ATTIVI/espansioni. APP di controllo FREECONTROL da ordinare a parte. Telecomando in dotazione. Alimentazione tramite alimentatore da ordinare a parte: AL3B fino a 2 diffusori AL5B fino a 4 diffusori

EN - Compact multimedia device for box 503 Made in Italy, HiFi Stereo, 25W+25W RMS (50+50W music) with Bluetooth, USB, FM Radio, DAB+ Radio, Microphone, 2 auxiliary inputs, PRE outputs for subwoofers/ACTIVE speakers/expansions. FREECONTROL control APP not included. Remote control included. Power supply not included: AL3B up to 2 speakers AL5B up to 4 speakers

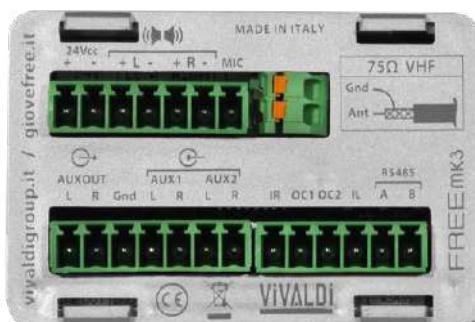

ordinare l'adattatore per la serie civile desiderata (vedi pag. 54-55)
order the adapter for the desired civil series (see p. 54-55)



EAN13 CODE

order the adapter for the desired civil series (see p. 54-55)

8051272188189	FREENETMK3.B* antracite / anthracite
8051272188202	FREENETMK3.S* silver
8051272188417	FREENETMK3.SABBIA* sand
8051272188196	FREENETMK3.W* bianco / white

compatibility BERKER B.7, BERKER S.1, GIRA STANDARD 55, GIRA E2, GIRA EVENT, GIRA ESPIRIT.

8051272189049	iFREETMK3.55B 55x55mm - antracite / anthracite
8051272189056	iFREETMK3.55S 55x55mm - silver
8051272189063	iFREETMK3.55W 55x55mm - bianco / white

compatibility JUNG LS990, JUNG LS DESIGN, JUNG LS PLUS.

8051272189230	iFREETMK3.70B 70x70mm - antracite / anthracite
8051272189247	iFREETMK3.70S 70x70mm - silver
8051272189254	iFREETMK3.70W 70x70mm - bianco / white

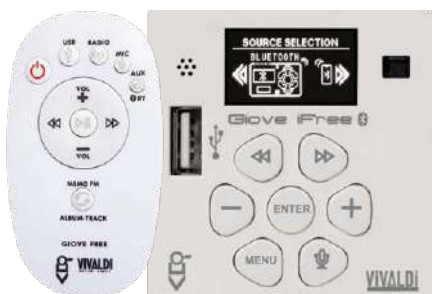

IT - come FREEMK3 ma per iCONTROL o integrazioni a domotiche terze.

EN - like FREEMK3 but for iCONTROL or integrations to third-party home automation.

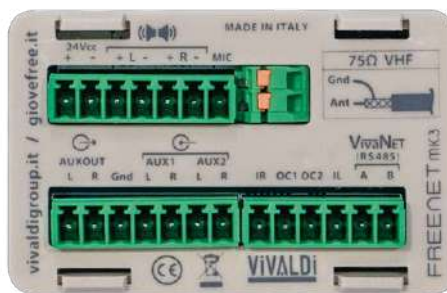

8051272188219	FREESOURCEMK3.B antracite / anthracite
8051272188226	FREESOURCEMK3.W bianco / white



IT - Multisorgente compatta con Bluetooth, USB, Radio FM, Radio DAB+, Microfono, 2 ingressi ausiliari. Uscita bilanciata. Telecomando in dotazione. Alimentazione tramite AL2B (da ordinare a parte).

EN - Compact multisource with Bluetooth, USB, FM Radio, DAB+ Radio, Microphone, 2 auxiliary inputs. Remote control included. Balanced output. Power supply via AL2B (not included).



SCHEMA DI COLLEGAMENTO FREE DIFFUSORI (MAX4) CONNECTION DIAGRAM SPEAKERS (TO FREE DEVICES) MAX 4 PCS

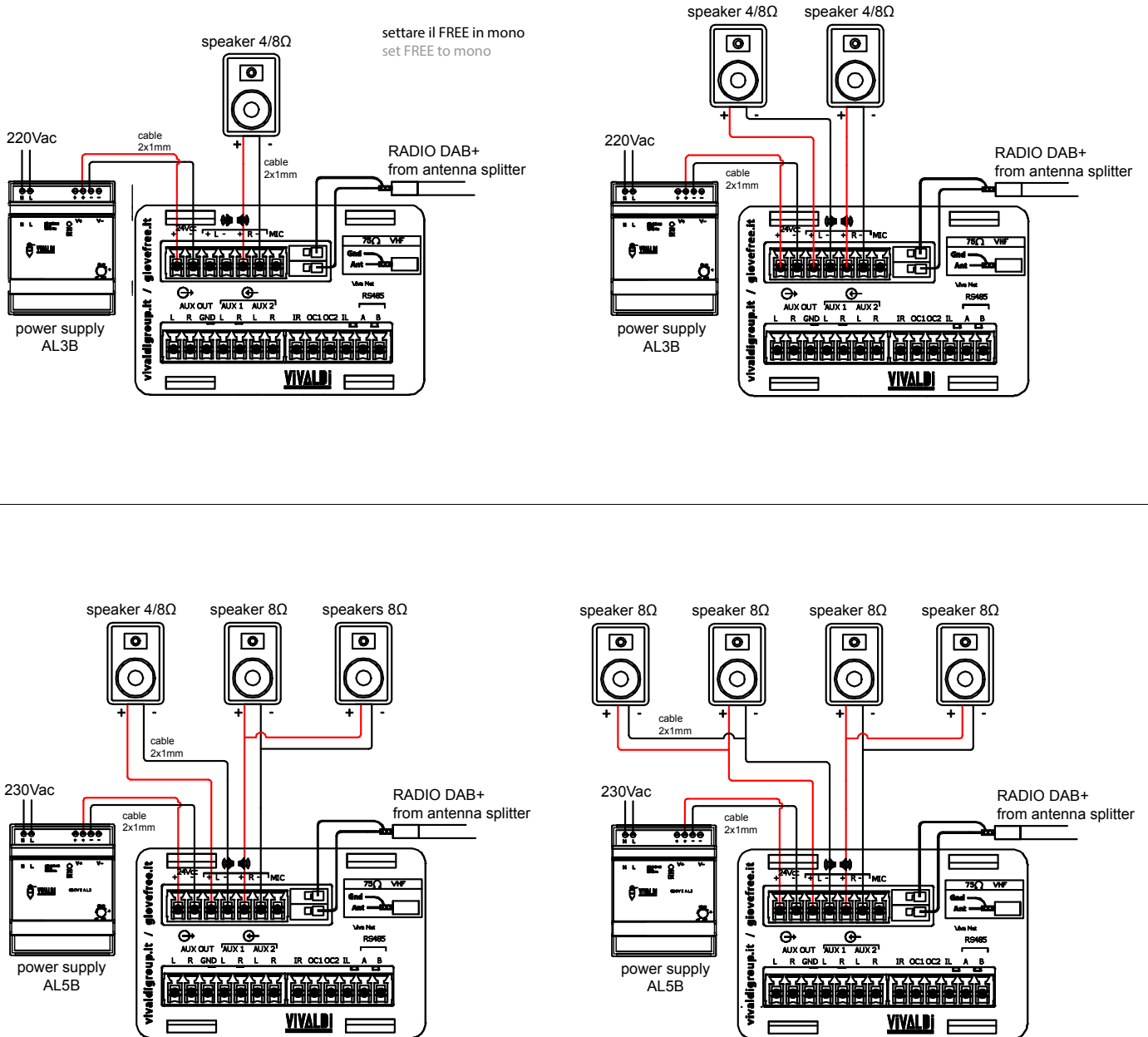





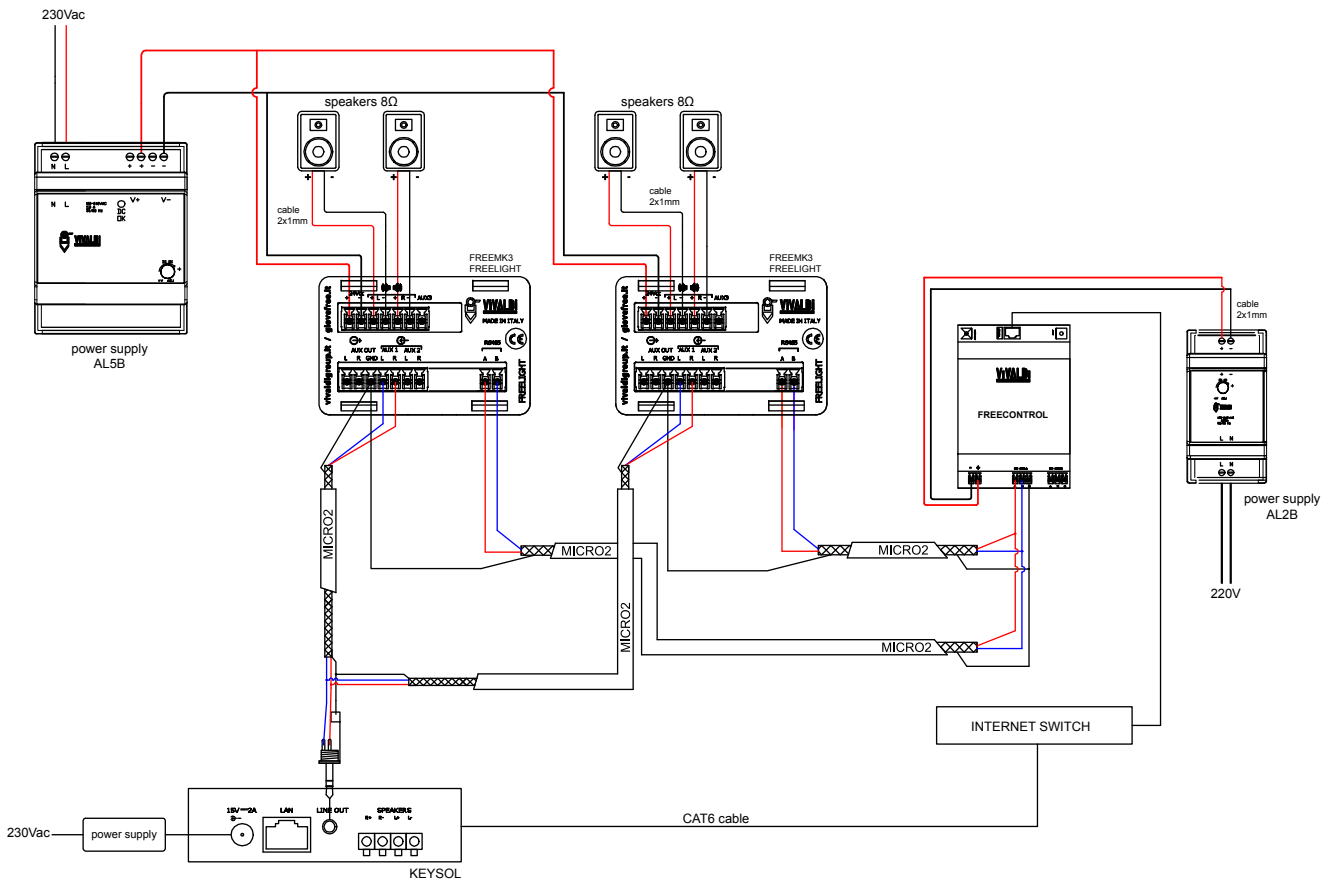



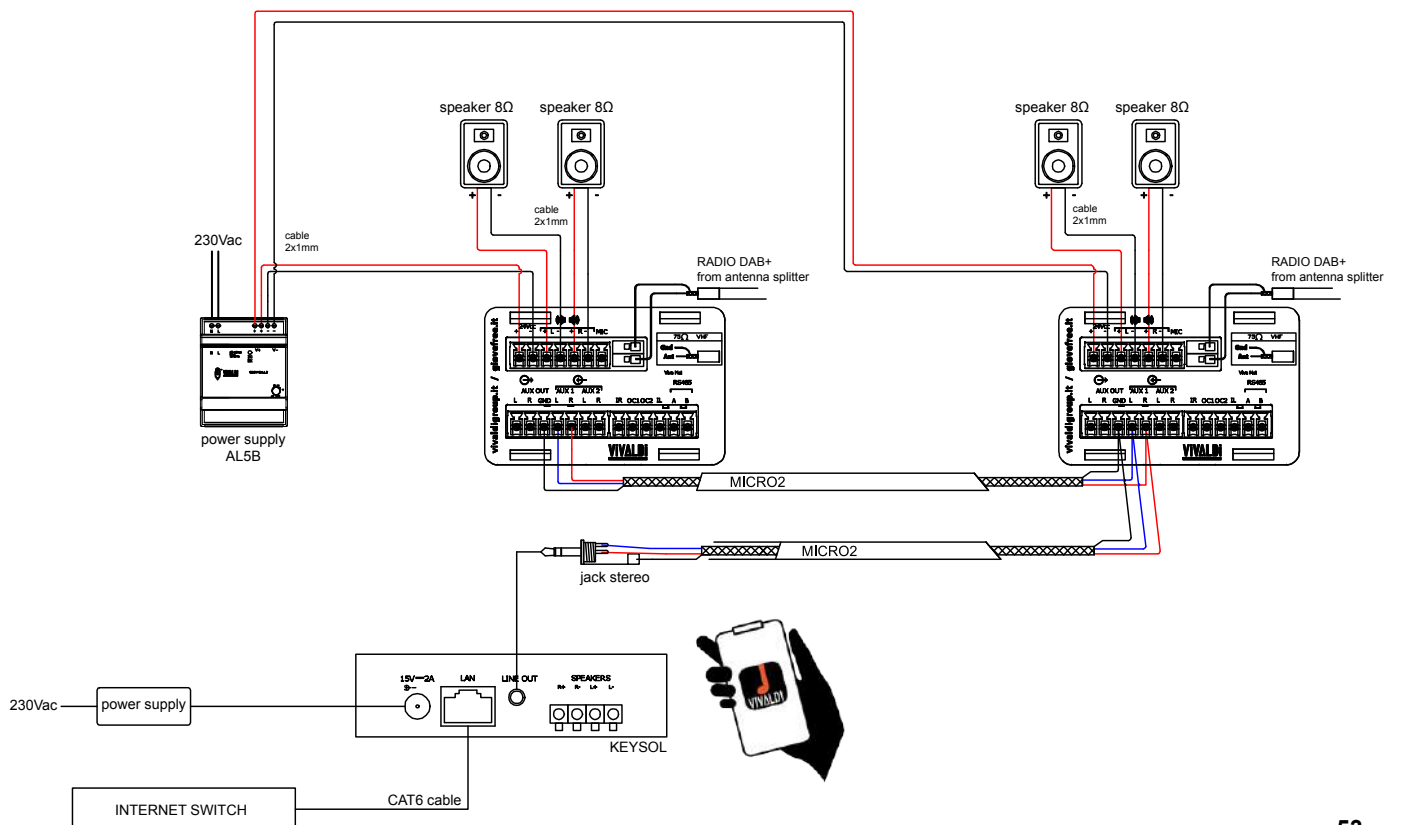







SCHEMA DI COLLEGAMENTO FREEMK3 O FREELIGHT CON FREECONTROL CONNECTION DIAGRAM FOR FREELIGHT OR FREEMK3 CABLED WITH FREECONTROL









SCHEMA DI COLLEGAMENTO KEYSOL CON 2 FREE CONNECTION DIAGRAM FOR 2 FREE CABLED WITH KEYSOL WIFI PLAYER



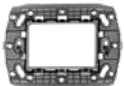





		EAN13	CODE
Vimar Idea Gewiss Playbus Abb Elos		8051272181760	AD1W adattatore bianco / white adapter
		8051272181746	AD1B adattatore nero / anthracite adapter
		8051272181753	AD1S adattatore silver / silver adapter
Ticinolnt / Air / Liv / Luna Modo / Master / Feb		8051272181791	AD2W adattatore bianco / white adapter
		8051272181777	AD2B adattatore nero / anthracite adapter
		8051272181784	AD2S adattatore silver / silver adapter
Ave Sistema 45		8051272181821	AD3W adattatore bianco / white adapter
		8051272181807	AD3B adattatore nero / anthracite adapter
		8051272181814	AD3S adattatore silver / silver adapter
Vimar Plana		8051272181852	AD4W adattatore bianco / white adapter
		8051272181838	AD4B adattatore nero / anthracite adapter
		8051272181845	AD4S adattatore silver / silver adapter
Legrand Vela (quadra e tonda)		8051272181883	AD5W adattatore bianco / white adapter
		8051272181869	AD5B adattatore nero / anthracite adapter
		8051272181876	AD5S adattatore silver / silver adapter
Axolute BTicino Axolute Air		8051272181913	AD6W adattatore bianco / white adapter
		8051272181890	AD6B adattatore nero / anthracite adapter
		8051272181906	AD6S adattatore silver / silver adapter
Eikon / Eikon EVO / Arkè		8051272181944	AD7W adattatore bianco / white adapter
		8051272181920	AD7B adattatore nero / anthracite adapter
		8051272181937	AD7S adattatore silver / silver adapter
Gewiss Chorus / Geo / Ice		8051272181975	AD8W adattatore bianco / white adapter
		8051272181951	AD8B adattatore nero / anthracite adapter
		8051272181968	AD8S adattatore silver / silver adapter
fornito montato su supporto a 3 moduli (503)* included mounted on 3-module support (503)*			
AVE sistema 44 / Life44 Domus100		8051272182002	AD9W adattatore bianco / white adapter
		8051272181982	AD9B adattatore nero / anthracite adapter
		8051272181999	AD9S adattatore silver / silver adapter
fornito montato su supporto a 3 moduli (503)* included mounted on 3-module support (503)*			
Matix e MatixGO		8051272181616	AD10W adattatore bianco / white adapter
		8051272181593	AD10B adattatore nero / anthracite adapter
		8051272181609	AD10S adattatore silver / silver adapter
Feel		8051272181647	AD11W adattatore bianco / white adapter
		8051272181623	AD11B adattatore nero / anthracite adapter
		8051272181630	AD11S adattatore silver / silver adapter
Urmet Nea / Simon / Expi		8051272181678	AD12W adattatore bianco / white adapter
		8051272181654	AD12B adattatore nero / anthracite adapter
		8051272181661	AD12S adattatore silver / silver adapter
fornito montato su supporto a 3 moduli (503)* included mounted on 3-module support (503)*			
ABB Myloss		8051272181708	AD13W adattatore bianco / white adapter
		8051272181685	AD13B adattatore nero / anthracite adapter
		8051272181692	AD13S adattatore silver / silver adapter
fornito montato su supporto a 3 moduli (503)* included mounted on 3-module support (503)*			



		EAN13	CODE
ABB Chiara		8051272181739	AD14W adattatore bianco / white adapter
		8051272181715	AD14B adattatore nero / anthracite adapter
		8051272181722	AD14S adattatore silver / silver adapter
Living Now		8051272187984	AD15W adattatore bianco / white adapter
		8051272187960	AD15B adattatore nero / anthracite adapter
		8051272188394	AD15SABBIA adattatore sabbia / sand adapter
Vimar Linea		 8052015550720	AD16W adattatore bianco / white adapte
		 8052015550737	AD16B adattatore nero / anthracite adapter
		 8052015550744	AD16C adattatore hemp / anthracite adapter

* produzione standard su supporto 3 moduli. Per abbinamenti a AUXIN o HDS, specificare al momento dell'ordine: "montato su supporto 4 moduli".
* standard production on support 3 modules. For pairings with AUXIN or HDS, specify when ordering: "mounted on 4 modules support"

		8051272189353	AL2B nero / black
			<p>IT - Alimentatore 2 moduli DIN. Input 100-240 Vac 50-60Hz 0,80A. Output 24 Vdc 1,25A. 30W. Peso: 0,18 Kg.</p> <p>EN - Power supply 2 DIN modules. Input 100-240 Vac 50-60Hz 0,80A. Output 24 Vdc 1.25A. 30W. Weight: 0,18 Kg.</p>

		8051272189360	AL3B nero / black
			<p>IT - Alimentatore 4,5 moduli DIN. Input 100-240 Vac 50-60Hz 1,8A. Output 24 Vdc 2,5A. Peso: 0,3 Kg.</p> <p>EN - Power supply 4.5 DIN modules. Input 100-240 Vac 50-60Hz 1.8A. Output 24 Vdc 2.5A. Weight: 0,3 Kg.</p>

		8051272180312	AL203
			<p>IT - Alimentatore ventilato. Input 180-264 Vac 50-60Hz 9,7A, 350W. Output 36 Vdc 9,7A. Dimensioni 215x115x50 mm (LxHxP). Peso 1 Kg.</p> <p>EN - Ventilated power supply. Input 180-264 Vac 50-60Hz 9.7A, 350W. Output 36 Vdc 9.7A. Size 215x115x50 mm (WxHxD). Weight 1 Kg.</p>



	EAN13	CODE		
	 8051272189377	AL5B nero / black	<p>IT - Alimentatore 7,5 moduli DIN. Input 100-240 Vac 50Hz 1,2A. Output 24 Vdc 4,16A, 100W. Peso: 0,33 Kg.</p>	<p>EN -Power supply 7.5 DIN modules. Input 100-240 Vac 50Hz 1.2A. Output 24 Vdc 4.16A, 100W. Weight: 0,33 Kg.</p>
	8051272183535	AL8 grigio / grey	<p>IT - Alimentatore 4 moduli DIN. Input 100-240 Vac 50-60Hz 3,3A. Output 24 Vdc 5A. Peso: 1,1 Kg.</p>	<p>EN - Power supply 4 DIN modules. Input 100-240 Vac 50-60Hz 3.3A. Output 24 Vdc 5A. Weight: 1,1 Kg.</p>
	8051272183511	AL201D bianco / white	<p>IT - Alimentatore da barra DIN da barra DIN (7,5 moduli) Input 100-240 Vac 50Hz 1,2A Output 36 Vdc 2,78A, 100W Dimensioni 138x88x65 mm (LxHxP) Peso 0,33 Kg</p>	<p>EN - DIN rail DIN rail (7.5 modules) Input 100-240 Vac 50Hz 1,2A Output 36 Vdc 2.78A, 100W Size 138x88x65 mm (WxHxD) Weight 0,33 Kg</p>
	8051272180336	TCIR5B nero / black	<p>IT - Telecomando ad infrarosso per GIOVE FREE. 11 pulsanti/funzioni.</p>	<p>EN - Infrared remote control for GIOVE FREE. 11 buttons/functions.</p>
	8051272180329	TCIR5W bianco / white		
	8051272184105	HDS*	<p>IT - Presa cuffie. Fornito montato su tappo copriforo. Indicare in ordine, serie civile e colore. Peso: 0,014 Kg.</p>	<p>EN - Headphone jack. Included mounted on hole cap. Indicate in order, civil series and color. Weight: 0,014 Kg.</p>
	8051272183542	AUXIN*	<p>IT - Ingresso AUX audio jack 3,5mm. Fornito montato su tappo copriforo. Cavo da 0,40 mt in dotazione. Indicare in ordine, serie civile e colore. Peso: 0,010 Kg.</p>	<p>EN - Input AUX audio jack 3.5mm. Included mounted on hole cap. 0.40 mt cable included. Indicate in order, civil series and color. Weight: 0,010 Kg.</p>
	8051272183634	BT01*	<p>IT - Tappo Bluetooth. Fornito montato su tappo copriforo. Indicare in ordine, serie civile e colore. Peso: 0,025 Kg.</p>	<p>EN - Bluetooth cap. Included mounted on hole cap. Indicate in order, civil series and color. Weight: 0,025 Kg.</p>

* Indicare al momento dell'ordine serie civile e colore desiderati. Cavo da utilizzare MICRO2 o MICRO4

* Please, indicate when ordering the desired civil series adapter and colour. Important: use cable MICRO2 or MICRO4



SCHEMA DI COLLEGAMENTO iCONTROL4.1L CON 2 FREENETMK3, DOMOTICA E MICROFONO iCONTROL4.1L WITH 2 FREENETMK3, CABLED FOR HOME AUTOMATION AND MICROPHONE

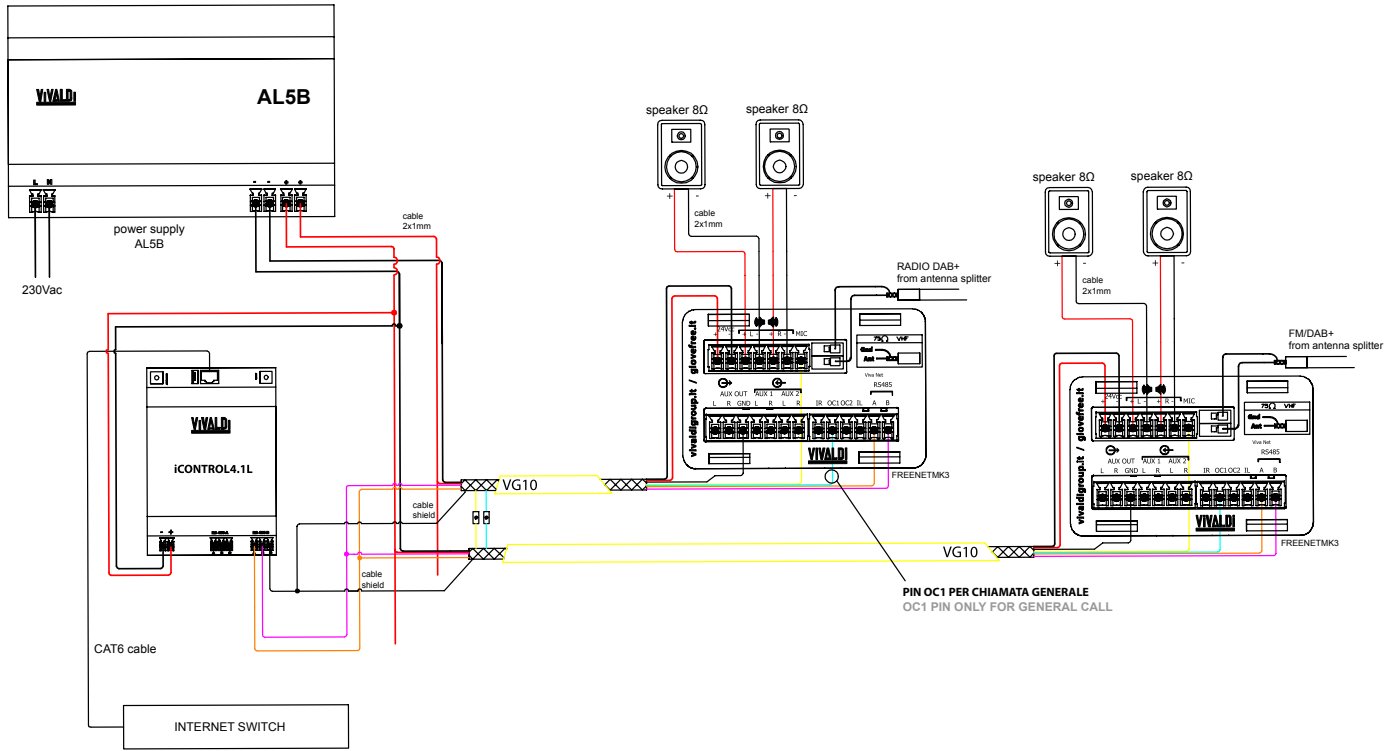

SCHEMA DI COLLEGAMENTO FREENETMK3 CON iCONTROL4.0+, MUSICO, DOMOTICA E PLAYER WIFI MULTIMEDIALE CONNECTION DIAGRAM OF FREENETMK3 WITH iCONTROL4.0+, MUSICO, HOME AUTOMATION AND WIFI MULTIMEDIA PLAYER

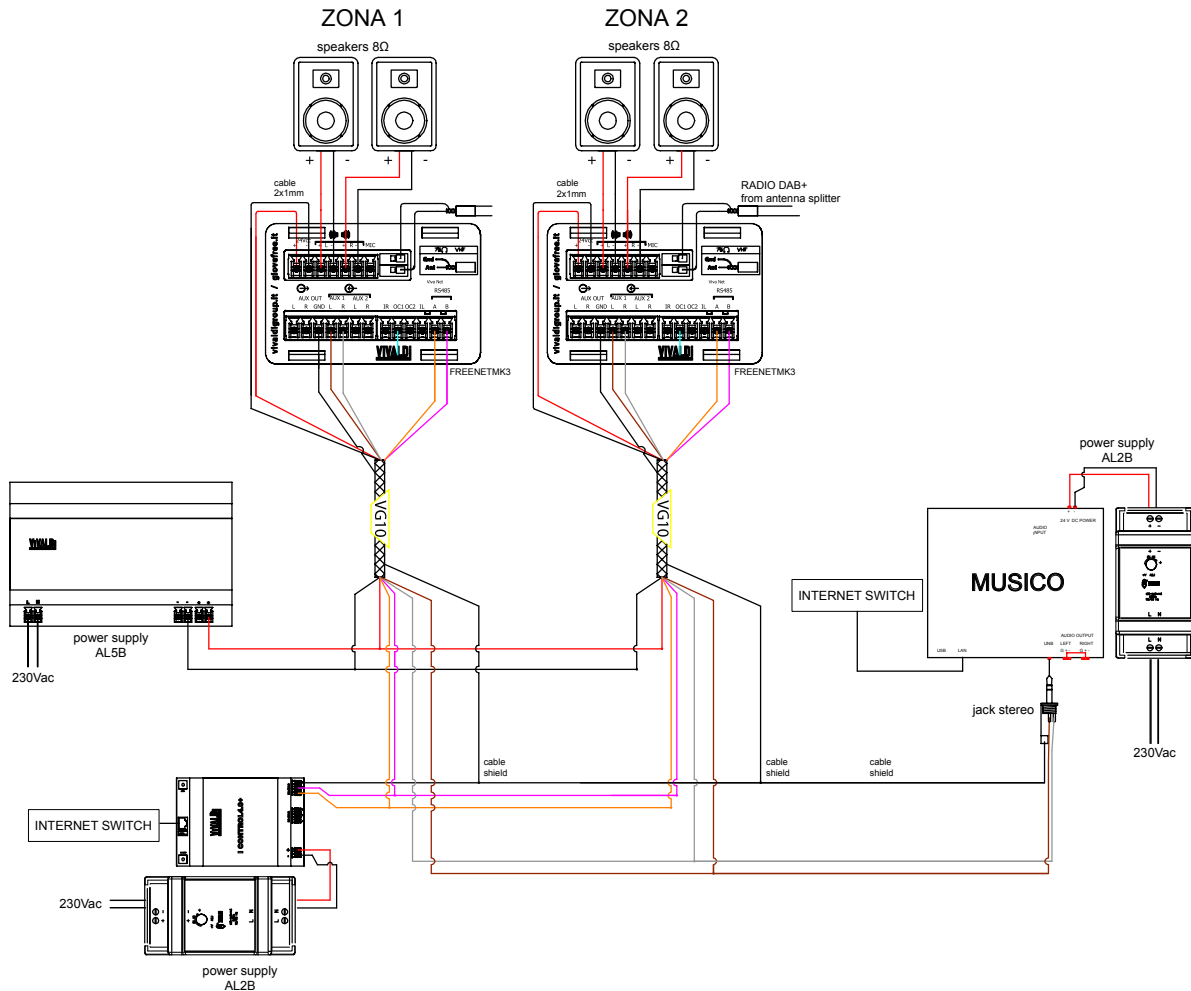



EAN13 CODE

8052015550294 CA48



IT - Centrale multimediale audio per FREELIGHT, FREEMK3, FREENETMK3, iFREEMK3.55, iFREEMK3.70. Predisposta per la gestione di 8 zone. 8 uscite, max 1 FREE per ogni uscita. Permette la gestione di 4 sorgenti in comune per tutto il sistema. 4 ingressi stereo analogici. Pulsante on/off sul pannello frontale con LED di stato. Dimensioni 483x44x305mm (LxHxP). Peso 2 Kg. 1 unita' rack, per alloggiamento a rack ordinare a parte P2G. Cavo di sistema VG10.50, VG10.100, VG10.200. Note: abbinabile a Vivaldi MULTIMEDIA KEYSOL-DIN, FREECONTROL, iCONTROL4.1L, iCONTROL4.0+.

EN - Multimedia audio center for FREELIGHT, FREEMK3, FREENETMK3, iFREEMK3.55, iFREEMK3.70. Prepared for the management of 8 powered zones. 8 outputs, max 1 FREE for each output. It allows the management of 4 sources in common throughout the system. 4 analog stereo inputs. On/off button on the front panel with status LED. Size 483x44x305mm (WxHxD). Weight 2 Kg. 1 rack unit, for rack mounting order separately Vivaldi Ulisse P2G. System cable VG10.50, VG10.100, VG10.200. Notes: can be combined with Vivaldi MULTIMEDIA KEYSOL-DIN, FREECONTROL, iCONTROL4.1L, iCONTROL4.0+.

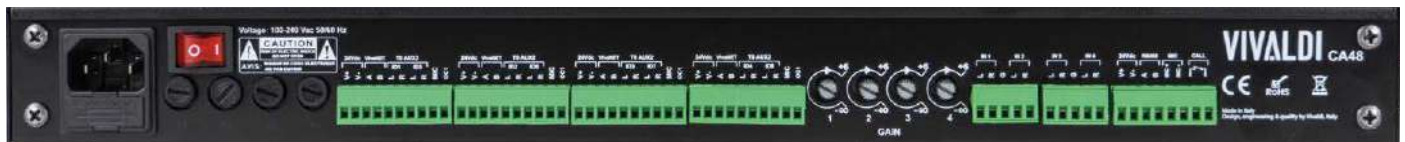

8051272186604 UNIVERSALGW



IT - Gateway RS232 + RS485, LAN. Kit completo di: UNIVERSALGW In dotazione: patch CAT5E 1mt, cavo RS232, alimentatore. Dimensioni (LxHxP) 93x84x26 mm. Peso: 0,25 Kg.

EN - Gateway RS232 + RS485, LAN. Kit with: UNIVERSALGW Included: patch CAT5E 1mt, RS232 cable, power supply. Size (WxHxD) 93x84x26 mm. Weight: 0,25 Kg.

8051272185560 PM2



IT - Base microfonica da tavolo, attiva. 192 zone. Display retroilluminato blu. Tipologia di chiamate generali: selettive o gruppi preprogrammati. Abbinabile ai sistemi multiroom o a FREECONTROL / iCONTROL. Dimensioni (LxHxP) 120x210x90mm. Peso: 2 Kg.

EN - Table microphone base, active. 192 zones. Blue backlit display. Type of general calls selective or pre-programmed groups. Can be combined with multiroom systems or FREECONTROL / iCONTROL. Size (WxHxD) 120x210x90mm. Weight: 2 Kg.

8051272182941 PS7



IT - Scheda commutatore/interruttore diffusori. Tipologia di utilizzo: sistemi Home Cinema. Uscite: 7x diffusori + 1 x subwoofer. Funzioni: commuta il collegamento di 4 diffusori + 1 subwoofer, dall'amplificatore del sistema surround al FREEMK3, FREENETMK3, iFREEMK3, Interrompe il collegamento di 3 diffusori. Dimensioni 150x50x130 (LxHxP) mm. Peso 0,45 Kg.

EN - Speakers switching/disconnecting system. Use: Home Cinema systems. Outputs: 7 x speakers, 1 x subwoofer. Functions: switching functioning of 4 speakers + 1 subwoofer, from the surround system amplifier to the FREEMK3, FREENETMK3, iFREEMK3. Disconnecting signal of 3 speakers. Dimensions 150x50x130 (WxHxD) mm. Weight 0,45 Kg.



8051272186369 **SIR1**



IT - Cavo infrarosso da 3 metri con sensore IR singolo. Colore nero. Dimensioni 10x10x3000 (LxHxP) mm. Peso 0,1 Kg.

EN - 3 meter infrared cable with single IR sensor. Black colour. Size 10x10x3000 (WxHxD) mm. Weight 0,1 Kg.

8051272182583 **VG10.50**

8051272182453 **VG10.100**

8051272182545 **VG10.200**

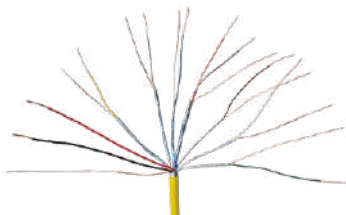

IT - Matassa cavo di sistema (adatto a vari cablaggi), 6 mm (diametro esterno). Disponibile in matassa da 50, 100, 200 mt.

EN - System cable skein (suitable for various wiring), 6 mm (external diameter). Available in skeins of 50, 100, 200 meters.





Video professional

EAN13

CODE

8051272186734 | **VM44HS Seamless**

IT - Matrice HDMI 4x4 seamless con scaler in uscita; permette di distribuire 4 sorgenti HDMI/VGA più audio analogico in ingresso a 4 uscite video HDMI, possibilità di fissare la risoluzione in uscita. Funzione multiview e videowall. Porta TX-Rx RS-232 per il controllo remoto. Gestione tramite pannello e display frontale. RS-232, IR, TCP/IP. Dimensioni (LxHxP) 440x45x200 mm. Peso: 2,4 Kg.

EN - 4x4 seamless HDMI matrix with output scaler; allows you to address 4 HDMI/VGA sources plus analog audio input to 4 HDMI video outputs, possibility to fix the output resolution. Multiview and video wall function. TX-Rx RS-232 port for remote control. Front panel and display, RS-232, IR, TCP/IP. Size (WxHxD) 440x45x200 mm. Weight: 2,4 Kg.





EAN13

CODE

8051272180640 **VM88H70E**



IT - Matrice HDMI/HDBaseT 8x8 completa di 8 ricevitori 70mt; permette di indirizzare 8 sorgenti HDMI audio/video in ingresso a 8 uscite video HDMI/HDBT. Ogni uscita dispone di una porta HDBT, una uscita HDMI (mirrored), una uscita audio L/R analogica, una uscita audio digitale coax, una porta TX-Rx RS-232. Uscite HDBT portata fino a 70mt con risoluzione 1080p60 con POC (alimentazione remota via cavo cat 5e/6). EDID configurabili. Gestione tramite pannello e display frontali, RS-232, IR e TCP/IP. Dimensioni (LxHxP) 440x88x362 mm. Peso: 6,7 Kg.

EN - HDMI/HD BaseT 8x8 matrix complete with 8 receivers 70mt ; Allows you to address 8 HDMI audio/video input sources to 8 HDMI/HDBT video outputs. Each output has an HDBT port, an HDMI (mirrored) output, an analog L/R audio output, a coax digital audio output, a TX-Rx RS-232 port. HDBT outputs up to 70mt with range 1080p60 resolution with POC (remote power supply via cat 5e/6 cable). Configurable EDIDs. Management via panel and front display, RS-232, IR and TCP/IP. Size (WxHxD) 440x88x362 mm. Weight: 6,7 Kg.



ricevitori HDBaseT
HDBaseT receiver

8051272180657 **VE70R**



IT - Ricevitore HDBaseT per matrice VM88H70E. Ingressi: 1x RJ45 (HDMI & Proprietary Data). 1x 3.5mm Stereo Mini-jack (IR). Uscite: 1x HDMI. 1x 3.5mm Stereo Mini-jack (IR). 1x RS232 Cabinet metallo verniciato nero. Dimensioni (LxHxP) 65x17x115 mm. Peso: 0,2 Kg.

EN - HD BaseT receiver for matrice VM88H70E. Inputs: 1x RJ45 (HDMI & Proprietary Data). 1x 3.5mm Stereo Mini-jack (IR). Outputs: 1x HDMI. 1x 3.5mm Stereo Mini-jack (IR). 1x RS232 Black painted metal cabinet. Size (WxHxD) 65x17x115 mm. Weight: 0,2 Kg.

EAN13 CODE

8051272181135 **VM44H100E**



IT - Kit matrice HDMI/HDBaseT 4x4 completa di 4 extender 100mt; permette di indirizzare 4 sorgenti HDMI audio/video in ingresso a 4 uscite video HDMI/HDBT. EDID configurabili. Gestione tramite pannello e display frontali, RS-232, IR, TCP/IP. Dimensioni (LxHxP) 440x45x200 mm. Peso: 1,82 Kg.

EN - Matrix HDMI/HD BaseT 4x4 kit, complete with 4 extenders 100mt; allows you to address 4xHDMI audio/video input to 4xHDMI/HDBT. Configurable EDID. Management through front panel display, RS-232, IR, TCP/IP. Size (WxHxD) 440x45x200 mm. Weight: 1,82 Kg.



8052015551093 **VM88H150E**



IT - Kit matrice HDMI/HDBaseT 8x8 completa di 8 extender 150mt; permette di indirizzare 8 sorgenti HDMI audio/video in ingresso a 8 uscite video HDMI/HDBT fino a 150m con risoluzione 1080p60 con POC (alimentazione remota via cavo cat 5e/6/7). Supporta il formato HDMI 2.0 con HDCP 2.2 e risoluzioni fino a 4K2K@60Hz(YUV4:4:4) su tutte le porte HDMI e HDBaseT. Supporta fino a 7.1 canali di High Definition audio (LPCM, Dolby TrueHD, e DTS-HD Master Audio). EDID configurabili. Gestione tramite pannello e display frontali, RS-232, IR, TCP/IP e protocollo ethernet (LAN), controllo CEC. Cabinet metallo verniciato black. Dimensioni 440x88x362 mm (LxHxP). Peso 6,7 Kg.

EN - HDMI/ HDBbaseT 8x8 Matrix kit, complete with 8 extender 150mt; it allows to address 8 HDMI audio/video input sources to 8 HDMI/HDBT video outputs up to 150m with 1080p60 resolution with POC (remote cat 5e/6/7 power supply). It supports HDMI 2.0 format with HDCP 2.2 and resolutions up to 4K2K@60hz(YUV4:4:4) on all HDMI and hdbaset ports. It supports up to 7.1 channels of High Definition audio (LPCM, Dolby truehd, and DTS-HD Master Audio). Configurable EDID. Management via front panel and display, RS-232, IR, TCP/IP and ethernet protocol (LAN), CEC control. Black painted metal cabinet. Dimensions 440x88x362 mm (WxHxD). Weight 6.7 Kg.

funzione sincro Audio Video
synchro Audio Video function

8051272180671 **VM66H70+**



IT - Matrice HDMI/HDBaseT 6x4+2; permette di indirizzare 6 sorgenti HDMI audio/video in ingresso a 4 uscite HDBaseT e 2 uscite HDMI. 6 uscite audio di linea L+R con mini Jack da 3,5mm e 6 uscite digitali Coax mirrored. Uscite HDBaseT portata fino a 70mt con risoluzione 1080p60 con POC (alimentazione remota via cavo cat 5e/6/7). La matrice ha 18 ingressi audio (6 HDMI + 2 audio analogici L+R + 2 audio coax + 2 audio toslink + 6 audio ARC) e 12 uscite audio (6 HDMI + 6 analogiche e coax). DSP per mute, gestione volume e delay per la sincronizzazione dell'audio col video. EDID configurabili. Gestione tramite pannello e display frontali, RS-232, IR e TCP/IP. Cabinet metallo verniciato black. Dimensioni (LxHxP) 483x45x303 mm. Peso 2,4 Kg.

EN - HDMI/HDBaseT 6x4+2 matrix; allows you to address 6 HDMI audio/video input sources to 4 HDBaseT outputs and 2 HDMI outputs. 6 L+R line audio outputs with 3.5mm mini jack and 6 mirrored Coax digital outputs. HDBaseT outputs up to 70mt with 1080p60 resolution and POC (remote power supply via cat 5e/6/7 cable). The matrix has up to a total of 18 audio inputs (6 HDMI + 2 analog audio L+R + 2 audio coax + 2 audio toslink + 6 arc audio) and 12 audio outputs (6 HDMI + 6 analog and coax). DSP for mute, volume management and delay for synchronizing audio with video. Configurable EDIDs. Management via panel and front display, RS-232, IR and TCP/IP. Cabinet metal painted black. Size (WxHxD) 483x45x303 mm. Weight 2,4 Kg.





extender HDMI per matrici HDMI HDBaseT
extender HDMI for matrix HDMI HDBaseT

VIVALDI

EAN13

CODE



8052015550102 **VE150H**



IT - Kit Extender
(ricevitore + trasmettitore).
HDBaseT da 150mt su singolo cavo cat 5e/6/7 con IR bidirezionale e RS-232. Supporta risoluzioni fino a 4K2K@60Hz(4:2:0), 4K2K@30Hz, 1080P@120Hz e 1080P 3D@60Hz. Supporta fino a 7.1 canali audio ad alta definizione (LPCM, Dolby TrueHD, e DTS-HD Master Audio). Supporta alimentazione 24V bidirezionale POC. Cabinet metallo verniciato nero. Dimensioni R/T 140x18x65 mm (LxHxP).
Peso 0,32 Kg.

EN - Kit Extender
(receiver + transmitter).
150mt HDBaseT on single cat 5e/6/7 cable with bidirectional IR and RS-232. Supports resolutions up to 4K2K@60Hz(4:2:0), 4K2K@30Hz, 1080P@120Hz and 1080P 3D@60Hz. Supports up to 7.1 channels of high-definition audio (LPCM, Dolby TrueHD, and DTS-HD Master Audio). Supports 24V bidirectional POC power supply. Black painted metal cabinet. Size R/T 140x18x65 mm (WxHxD).
Weight 0,32 Kg.



8052015550119 **VE150IP**



IT - Kit Extender
(ricevitore+trasmettitore).
Supporta risoluzioni 1920x1200@60Hz CAT5e/6 fino a 150mt. HDMI compliance 1.3. HDCP compliance 1.4. HDMI audio format: LPCM2.0CH, 32KHZ, 44.1KHz, 48KHz. Alimentazione 5V (alimentatore in dotazione). Cabinet metallo verniciato nero. Dimensioni R/T 88x16,5x61,2 mm (LxHxP).
Peso 0,32 Kg.

EN - Extender kit
(receiver+transmitter).
Supports 1920x1200@60Hz CAT5e/6 resolutions up to 150mt. HDMI compliance 1.3. HDCP compliance 1.4. HDMI audio format: LPCM2.0CH, 32KHZ, 44.1KHz, 48KHz. Power supply 5V (included). Black painted metal cabinet. Size R/T 88x16,5x61,2 mm (WxHxD).
Weight 0,32 Kg

8051272188868 **VE50IPH** in esaurimento / EOL



IT - Kit Extender WIRELESS
(ricevitore+trasmettitore).
Portata max 50mt.
Risoluzione massima 1920x1200@60Hz.
HDMI/HDCP.
Connessioni:
trasmettitore: Ingressi 1 x HDMI
Uscite 1 x IR + 1 x WiFi (antenna)
ricevitore: ingressi 1 x IR + 1 x WiFi (antenna)
uscite 1 x HDMI
Cabinet metallo verniciato nero.
Dimensioni R/T (LxHxP) 125x16x72 mm. In dotazione: doppio alimentatore.
Peso kit 0,53 Kg.

EN - WIRELESS Extender Kit
(receiver+transmitter).
Max range 50mt.
Maximum resolution 1920x1200@60Hz.
HDMI/HDCP.
Connections:
Transmitter: 1 x HDMI Inputs
Outputs 1 x IR + 1 x WiFi (antenna)
Receiver: 1 x IR + 1 x WiFi inputs (antenna)
1 x HDMI outputs
Black painted metal cabinet.
Size R/T (WxHxD) 125x16x72 mm.
Double power supply included.
Weight Kit 0,53 Kg.

EAN13 CODE

NEW 8052015550096 **VSP14HA**



IT - Splitter HDMI 1x4; duplica un segnale HDMI in ingresso su 4 uscite. Supporta segnali fino a 4K2K 60Hz con 24bit RGB/YCBCR 4:4:4/YCBCR 4:2:2. Supporta audio LPCM 7.1CH, Dolby TrueHD e DTS-HD Master Audio. Uscita analogica audio L/R stereo. Uscita audio digitale toslink. Alimentazione 5V (alimentatore in dotazione). Cabinet metallo verniciato nero. Dimensioni 180x14x62 mm (LxHxP). Peso 0,227Kg.

EN - HDMI splitter 1x4; duplicates an hdmi input signal on 4 outputs. Supports signals up to 4K2K 60Hz with 24bit RGB/YCBCR 4:4:4 YCBCR 4:2:2. Supports LPCM 7.1CH, Dolby TrueHD, and DTS-HD Master Audio. Analog audio output L/R stereo. Toslink digital audio output. Power supply 5V (included). Black painted metal cabinet. Size 180x14x62 mm (WxHxD). Weight 0,227Kg.



8051272180602 **VSP18H**



IT - Splitter HDMI 1x8; duplica un segnale HDMI in ingresso su 8 uscite. Dimensioni (LxHxP) 23x20x84 mm. Peso: 0,36Kg.

EN - HDMI Splitter 1x8; Duplicate an HDMI input signal on 8 outputs. Size (WxHxD) 23x20x84 mm. Weight: 0,36Kg.



8051272180619 **VSW41H**



IT - Switch HDMI 4x1; Indirizza uno dei 4 segnali HDMI in ingresso su una uscita HDMI. Controllabile tramite porta RS-232, IR e pulsantiera. Dimensioni (LxHxP) 180x116x85 mm. Peso: 0,3Kg

EN - HDMI Switch 4x1; Route one of the 4 input HDMI signals to an HDMI output. Control via RS-232 port, IR and push-button panel. Size (WxHxD) 180x116x85 mm. Weight: 0,3Kg





EAN13 CODE

8052015551062 **VSW41HSMK2**



IT - Switch seamless video UHD multiviewer 4K60 4x1. Controllabile tramite i pulsanti del pannello frontale, telecomando IR, navigazione del menu OSD, software del controller, comandi RS-232. Dimensioni 118x32x250 mm (LxHxP). Peso 0,75Kg.

EN - 4K60 4x1 UHD multiviewer seamless video switch. Controllable via front panel buttons, IR remote control, OSD menu navigation, controller software, RS-232 commands. Dimensions 118x32x250 mm (WxHxD). Weight 0.75Kg

8051272180626 **VPS70A**



IT - Kit Presenter Switch con ricevitore. Presenter Switch HDMI-HD BaseT 5x1 con 3 ingressi HDMI 1 ingresso Display Port e 1 ingresso VGA. 1 uscita HDMI e HDBaseT "mirrored" da 70mt. Mixer audio con un ingresso analogico L+R per ogni ingresso HDMI/DP/VGA. Ricevitore VE70R compreso. Dimensioni (LxHxP) 150x44x220 mm. Peso: 1,25 Kg.

EN - Kit Presenter Switch with Receiver. Presenter Switch HDMI-HD BaseT 5x1 with 3 HDMI inputs 1 Display Port input and 1 VGA input. 1 HDMI and HD BaseT "mirrored" 70mts range. Audio mixer with one L+R analog input for each HDMI/DP/VGA input. VE70R receiver included. Size (WxHxD) 150x44x220 mm. Weight: 1,25 Kg.



8051272186352 **SDIHDMI**



IT - Convertitore video da 3G-HD-SDI a HDMI.

EN - Converter video 3G-HD-SDI to HDMI.

8051272184099 **HDMISDI**



IT - Convertitore video da HDMI a 3G-HD-SDI.

EN - Converter video 3G-HD-SDI to HDMI.

8051272186765 **VREC50** in esaurimento / EOL



IT - Recorder HDMI su memoria di massa (non inclusa) da connettere tramite porta USB 2.0. Ingressi: 1x HDMI + 2x USB. Uscite: 1x HDMI. Dimensioni (LxHxP) 134x24x78 mm. Peso: 0,12 Kg.

EN - HDMI Recorder on Memory Mass (not included) to be connected via USB 2.0 port. Inputs: 1x HDMI + 2x USB. Outputs: 1x HDMI. Size (WxHxD) 134x24x78 mm. Weight: 0,12 Kg.

EAN13 CODE

8051272188134 **VAEXT2**



IT - HDMI audio extractor.
Estrae il segnale audio da una sorgente HDMI su una uscita audio L/R analogica e una digitale multicanale spdif optical.
Dimensioni (LxHxP) 130x19x75 mm.
Peso 0,2 Kg.

EN - HDMI audio extractor.
Extracts the audio signal from an HDMI source over an analog L/R audio output and a digital multichannel spdif optical.
Size (WxHxD) 130x19x75 mm.
Weight 0,2 Kg.



8051272186611 **VCD2A**



IT - Convertitore audio DAC da ingresso digitale coassiale e/o Toslink ad analogico L+R.
Ingresso 1x RCA [Coaxial Audio]
1x Optical [S/PDIF].
Uscite 2x RCA [Stereo Audio].
Dimensioni (LxHxP) 51x26x41 mm.
Peso: 0,78 Kg.

EN - DAC audio converter from coaxial and/or Toslink to analog L+R digital input.
1x RCA Input [Coaxial Audio]
1x Optical [S/PDIF].
2x RCA [Stereo Audio] outputs.
Size (WxHxD) 51x26x41 mm.
Weight: 0,78 Kg.



8052015550089 **VDAC**

IT - Convertitore audio DAC da ingresso analogico L/R a uscita digitale coassiale e/o Toslink.
Ingresso 2x RCA [Stereo Audio].
Uscita 1x RCA [Coaxial Audio].
1x Optical [S/PDIF].
Colore nero.
Dimensioni 51x26x41 mm (LxHxP).
Peso 0,78 Kg.

EN - DAC audio converter from analog L/R input to coaxial digital output and/or Toslink.
2x RCA [Stereo Audio] input.
1x RCA [Coaxial Audio] output.
1x Optical [S/PDIF].
Black Color.
Size 51x26x41 mm (WxHxD).
Weight 0,78 Kg

8051272186703 **VHRPT** in esaurimento / EOL



IT - Repeater HDMI con funzione di UP e DOWN scaling.
Amplifica ed equalizza il segnale HDMI consentendone il trasporto su cavo HDMI fino a 10mt in 4K o 20mt in 1080p.
Ingressi 1x HDMI + 1x DC power connector + 1x USB Connector + 1x Scaling Button.
Uscite 1x HDMI.
Dimensioni (LxHxP) 80x20x50 mm.
Peso: 0,2 Kg

EN - HDMI repeater with UP and DOWN scaling function.
Amplifies and equalizes the HDMI signal allowing it to be transported on HDMI cable up to 10mt in 4K or 20mt in 1080p.
1x HDMI + 1x DC power connector + 1x USB Connector inputs + 1x Scaling Button.
1x HDMI outputs.
Size (WxHxD) 80x20x50 mm.
Weight: 0,2 Kg



cavi HDMI, versione 1.4 intestato
HDMI cable, version 1.4 headed

VIVALDI

		EAN13	CODE
	8051272184020		HDMI0.5 - 0.5 mt
	8051272184037		HDMI1 - 1 mt
	8051272184068		HDMI2 - 2 mt
	8051272184075		HDMI3 - 3 mt
	8051272184082		HDMI5 - 5 mt
	8051272184044		HDMI10 - 10 mt
	8051272184051		HDMI15 - 15 mt





Device

for professional

& Public

Address solutions



	EAN13	CODE
	8051272188875	MA5060BTK
	8051272188882	MA5120BTK
	8051272188899	MA5240BTK



	MA5060BTK	MA5120BTK	MA5240BTK
Descrizione / Description	mixer amplificato con player integrato per l'ascolto di sorgenti WiFi, radio FM, MP3 USB, SD, Bluetooth amplifier mixer 60W with player KEYSOL, BLUETOOTH source, FM TUNER, USB and SD CARD integrated		
Potenza / Power	60W	120W	240W
Ingressi / IN	6 ingressi miscelabili + sorgenti 6 IN mixable + sources	6 ingressi miscelabili + sorgenti 6 IN mixable + sources	6 ingressi miscelabili + sorgenti 6 IN mixable + sources
Uscite altoparlanti / Out speakers	4-8-16 Ω, 70/100V	4-8-16 Ω, 70/100V	4-8-16 Ω, 70/100V
CH1	mic XLR 5-8mV 600Ω, phantom talkover (sel.)		
CH2	mic Jack 5-8mV 600Ω / line RCA 150-470mV 10KΩ (comm.)		
CH3	mic Jack 5-8mV 600Ω / line RCA 150-470mV 10KΩ (comm.)		
CH4	line RCA	line RCA	line RCA
CH5	line RCA	line RCA	line RCA
CH6	tel. 600Ω 100mV	tel. 600Ω 100mV	tel. 600Ω 100mV
Line out RCA	0,775V (0dBV)	0,775V (0dBV)	0,775V (0dBV)
Alimentazione / Power supply	AC110-240V & 24Vdc	AC110-240V & 24Vdc	AC110-240V & 24Vdc
Toni / Tones	alti/bassi / high/low	alti/bassi / high/low	alti/bassi / high/low
Consumo / Consumption	100VA	200VA	310VA
Dimensioni (LxHxP) / Size (WxHxD)	300x88x275 mm	300x88x275 mm	488x88x405 mm
Peso / Weight	4 kg	4,6 kg	9 kg
Accessori in dotazione / Accessories included	telecomando / remote control	telecomando / remote control	telecomando / remote control
Standard rack	tramite PSK / via PSK (2U)	tramite PSK / via PSK (2U)	2U
Cabinet	metallo / metal	metallo / metal	metallo / metal
Colore / Colour	nero, serigrafie arancioni / black, orange serigraphs		



mixer multizona 6 zone con sorgenti integrate, volumi indipendenti
multizone mixer, 6 zones, with integrated sources and independent volumes

VIVALDI

EAN13	CODE
-------	------



	8051272188905	MZ6120BTK
	8051272188912	MZ6240BTK
	8051272187168	MZ6350BT EOL senza player Keysol ma con DAB+
	8051272188929	MZ6350BTK
	8051272187175	MZ6500BT EOL senza player Keysol ma con DAB+
	8052015550003	MZ6500BTK
BM6	8051272187182	BM6 base microfonica multizona / multizone microphone base



	MZ6120BTK	MZ6240BTK	MZ6350BTK	MZ6500BTK
Descrizione / Description	mixer amplificato multizona, volumi indipendenti su 6 zone, con player integrato per l'ascolto di sorgenti WiFi, radio FM, MP3 USB, SD, Bluetooth. multizones mixer amplifier with independent volumes on 6 zones and integrated with player KEYSOL, BLUETOOTH source, FM TUNER, USB and SD CARD integrated			
Potenza / Power	120W	240W	350W	500W
Ingressi / IN	6 ingressi miscelabili + sorgenti + ingresso emergenza prioritario + base microfonica multizona 6 mix. Inputs + sources + priority emergency input + multi-zone desk microphone			
Uscite altoparlanti / Out speakers	100V	100V	100V	100V
Antenna 75Ω	per ricezione / for reception RADIO FM	per ricezione / for reception RADIO FM	per ricezione / for reception RADIO FM	per ricezione / for reception RADIO FM
CH1 (priority)	mic Jack 5-8mV 600Ω	mic Jack 5-8mV 600Ω	mic Jack 5-8mV 600Ω	mic Jack 5-8mV 600Ω
CH2-3-4	mic XLR 5-8mV 600Ω alimentazione phantom (selezionabile) / line XLR 150-470mV 10KΩ (commutabili) mic XLR 5-8mV 600Ω, phantom supply (selectable) / line XLR 150-470mV (switchable)			
CH5-6	line RCA	line RCA	line RCA	line RCA
CH7 EMC	ingresso di emergenza prioritario per messaggi di evacuazione o di servizio priority emergency input for evacuation or service messages			
CH8	paging ingresso base microfonica multizona BM6 / paging multi-zone desk microphone input BM6			
Line out RCA	0,775V (0dBV) uscita dipendente dai canali di ingresso e indipendente dal volume 0,775V (0dBV) output dependent on input channels and independent on volume			
Alimentazione / Power supply	AC110-240V & 24Vdc	AC110-240V & 24Vdc	AC110-240V & 24Vdc	AC110-240V & 24Vdc
Funzione / Function	mute regolabile / mute adjustable	mute regolabile / mute adjustable	mute regolabile / mute adjustable	mute regolabile / mute adjustable
Toni / Tones	alti/bassi / high/low	alti/bassi / high/low	alti/bassi / high/low	alti/bassi / high/low
Consumo / Consumption	200VA	400VA	500VA	650VA
Messaggistica / Messages	BM6 Base microfonica multizona 6 zone / BM6 Multizones microphone base 6 zones			
Dimensioni (LxHxP) / Size (WxHxD)	484x88x405 mm	484x88x405 mm	484x88x405 mm	484x88x405 mm
Peso / Weight	8,6 kg	9,4 kg	9,8 kg	10,25 kg
Accessori / Accessories	telecomando / remote control	telecomando / remote control	telecomando / remote control	telecomando / remote control
Standard rack	2U	2U	2U	2U
Cabinet	metallo / metal	metallo / metal	metallo / metal	metallo / metal
Colore / Colour	nero, serigrafie arancioni / black, orange serigraphs			



EAN13	CODE
-------	------



8051272187991	MS6060BT EOL senza player Keysol ma con DAB+
8051272187199	MS6120BT EOL senza player Keysol ma con DAB+
8051272189735	MS6120BTK
8051272189742	MS6240BTK
8051272187205	BS6 base microfonica multizona / multizone microphone base
8051272187212	CR1 controllo remoto di zona / remote zone control



	MS6120BTK	MS6240BTK
Descrizione / Description	matrice amplificata multizona con player integrato per l'ascolto di sorgenti WiFi, radio FM, MP3 USB, SD e Bluetooth, selezione sorgenti (player) e volumi indipendenti in ogni zona matrix with player KEYSOL, BLUETOOTH source, FM TUNER, USB and SD CARD integrated for MP3 audio files reading source selection and independent volumes on each zone	
Potenza / Power	6x120W	6x240W
Ingressi / Inputs	3 IN MIC/LINE + 1 AUX IN	3 IN MIC/LINE + 1 AUX IN
Uscite altoparlanti / Out speakers	4-16 Ω, 100V	4-16 Ω, 100V
Antenna 75Ω	per ricezione / for reception RADIO FM	
CH1 MP3	player WiFi KEYSOL, BLUETOOTH, TUNER FM, USB, SD CARD gestioni delle zone tramite pulsanti. internal sources WiFi KEYSOL, BLUETOOTH, FM TUNER, USB, SD CARD zone management by buttons	
CH2-3-4	mic COMBO 5-8mV 600Ω alimentazione phantom (selezionabile) / line XLR 150-470mV 10KΩ (commutabili) mic COMBO 5-8mV 600Ω Phantom power (selectable) / line XLR 150-470mV 10KΩ (switchable)	
CH5	ingresso / input AUX RCA	ingresso / input AUX RCA
CH6 EMC	ingresso di emergenza prioritario per messaggi di evacuazione o di servizio GRM1 priority emergency input for service or evacuation messages GRM1	
Line out RCA	0,775V (0dBV), ogni uscita è controllata dal volume di zona 0,775V (0dBV), each output is controlled by the volume zone.	
Uscite / Outputs	6 uscite RJ45 per comandi di zona CR1 o basi microfoniche multizona BS6 2 uscite monitor con controllo volume e pulsante (pannello frontale) per seleziona zona JACK 6,3mm per cuffia sul pannello frontale RCA per diffusori attivi sul pannello posteriore le 6 uscite supportano anche 12 dispositivi collegando 6 CR1 sul COM02 delle basi BS6 6 RJ45 Outputs for CR1 controls or BS6 multi-zone paging station 2x Monitor Outputs for volume adjustment and button (front panel) for zone selection JACK 6,3 mm for headphone on front panel RCA for active speaker on back panel 6 outputs also support 12 devices by connecting 6 CR1 on COM02 of BS6 bases	
Morsetti Horn	applicando una tensione continua di 24V si attiva il messaggio preregistrato (interno) per l'evacuazione. activating a 24V continuous voltage activates the pre-recorded (internal) evacuation message	
Alimentazione / Power supply	AC110-230V & 24Vdc	AC110-230V & 24Vdc
Funzione / Function	mute	mute
Toni / Tones	alti e bassi sugli ingressi C2, C3, C4, C5 tramite trimmer / treble/bass controls via trimmer on inputs C2, C3, C4, C5	
Consumo / Consumption	900VA	900VA
Dimensioni (LxHxP) / Size (WxHxD)	448x88x405 mm - 8 kg	448x88x405 mm - 8 kg
Accessori in dotazione / Accessories included	telecomando e cavo antenna FM / remote control and FM cable	
Standard rack	tramite PSK / via PSK (2U)	tramite PSK / via PSK (2U)
Cabinet e colore / Cabinet and Colour	metallo nero, serigrafie arancioni / metal black, orange serigraphs	



EAN13 CODE

8051272187182 **BM6**



IT - Base microfonica multizona, paging, remota, da tavolo, con pulsanti, per amplificatori MZ6120BTK, MZ6240BTK, MZ6350BT, MZ6350BTK, MZ6500BT e MZ6500BTK.

Chiamata a 6 zone. Priorità tramite gli interruttori dip switch. 6 pulsanti selezione zona. Connettore microfono gooseneck. Indicatori alimentazione, comunicazione, occupato, zona. Pulsante chiama/parla. Interruttore ON/OFF. Porta RJ45 per connettere la base successive in cascata. Porta RJ45 di comunicazione con l'amplificatore. Controllo gain microfono. Asta da 41cm. Ingresso Aux locale. Alimentazione tramite link all'amplificatore con cavo CAT6 connettore RJ45.

Linkabile in cascata (fino a 6 basi) per una lunghezza massima di 300mt (amplificatore - ultima base). Peso 0,9 Kg.

EN - Multi-zone, paging, remote, desktop, push button microphone base for MZ6120BTK, MZ6240BTK, MZ6350BT, MZ6350BTK, MZ6500BT and MZ6500BTK amplifiers.

6-zone call. Priority via dip switches. 6 zone selection buttons. Gooseneck microphone connector. Indicators power, communication, busy, zone. Call/speak button. ON/OFF switch. RJ45 port to connect the next base station in daisy chain. RJ45 port to communicate with the amplifier. Microphone gain control. 41cm rod. Local Aux entrance. Power supply via link to the amplifier with CAT6 cable RJ45 connector. **Daisy chain linkable (up to 6 bases) for a maximum length of 300mt (amplifier - last base).** Weight 0,9 Kg.

8051272187205 **BS6**



IT - come BM6 ma per matrici MS6060BT, MS6120BT, MS6120BTK e MS6240BTK

EN - as BM6 for MS6060BT, MS6120BT, MS6120BTK and MS6240BTK matrices

8051272187212 **CR1**



IT - Controllo remoto di zona, touch panel, da incasso. Per matrici MS6060BT, MS6120BT, MS6120BTK e MS6240BTK.

Ogni matrice gestisce fino a 6 CR1 (controlli di zona indipendenti). Alimentazione tramite link all'amplificatore con cavo CAT5E/CAT6 connettore RJ45, lunghezza massima di 200mt per singola linea. Dimensioni (LxHxD) 86x86x35 mm. Peso 0,2kg. Colore bianco satinato, serigrafato, retroilluminato. Necessita di scatola da incasso SC100 (da ordinare a parte). Note: il controllo remoto di zona CR1 viene indirizzato di fabbrica (assegnazione numero di zona). In fase d'ordine indicare il numero di zone richieste. La centrale supporta fino a 6 dispositivi tra CR1 e basi microfoniche BS6.

EN - Remote zone control, touch panel, recessed. For MS6060BT, MS6120BT, MS6120BTK e MS6240BTK arrays.

Each matrix handles up to 6 CR1s (independent zone controls). Power supply via link to the amplifier with CAT5E/CAT6 cable RJ45 connector, maximum length of 200mt per single line. Size (WxHxD) 86x86x35 mm. Weight 0,2kg. Satin white color, silk-screened, backlit. Requires built-in box SC100 (not included). Note: CR1 zone remote control should be addressed from the factory (zone number assignment). When ordering, indicate the number of zones required. The control panel supports up to 6 devices between CR1 and BS6 microphone bases.

8051272186321 **SC100** bianco / white



IT - Scatola da incasso per controllo remoto di zona, touch panel CR1
Peso: 0,15Kg.

EN - Built-in box for remote control of the area, CR1 touch panel
Weight: 0,15Kg.



EAN13	CODE
8051272188028	GRM1
8051272189353	AL2B

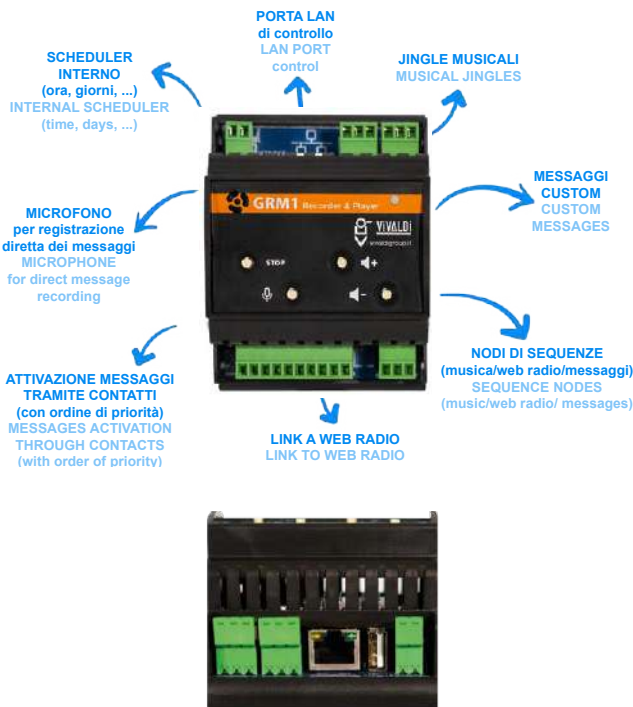

IT - Registratore, generatore di messaggi di evacuazione, allarme, sicurezza o pubblicità.

Possibilità:

- riprodurre Jingle musicali
- gestire WebRadio da timer
- creare nodi con sequenze musica/link web radio/messaggi a piacere
- messaggi tramite contatti (timer o impianti di sicurezza)

Numero messaggi registrabili: 100.
Tempo totale: 120 minuti.
Memoria interna 16GB.
Lettura MP3, FLAC, WAV.
Scheduler interno.
1 ingresso LAN per programmazioni.
Aggiornamenti da remoto.
8x ingresso per messaggi in ordine di priorità.
1x microfono integrato per registrazione messaggi.
1x uscita (contatto pulito) per attivazione di apparecchiature con contatto prioritario.
Batteria tampone.
Alimentazione 24 Vdc (tramite AL2B da ordinare a parte).
Dimensione (LxHxP) 72x90x63 mm.
Standard DIN (4 moduli).
Peso: 0,2 Kg.

EN - Recorder, generator of evacuation messages, alarm, security or advertising.

Possibility:

- make musical Jingles
- link WebRadio with timer
- create nodes with music sequences / web radio links / messages at will
- messages via contacts (timers or security systems)

Number of recordable messages: 100. Total time: 120 minutes.
16GB internal memory.
Read MP3, FLAC, WAV.
Internal scheduler.
1 LAN input for programming.
Remote updates.
8x input for messages in order of priority.
1x integrated microphone for message recording.
1x output (clean) contact for the activation of equipment with priority contact. Battery.
Power supply 24 Vdc (via AL2B not included).
Size (WxHxD) 72x90x63 mm.
DIN standard (4 modules).
Weight: 0,2 Kg.

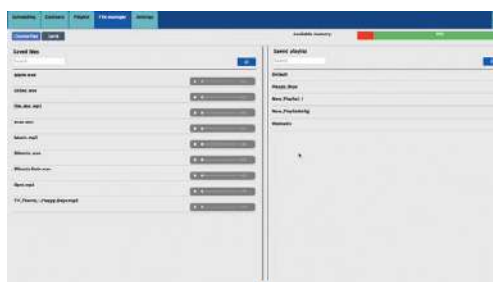
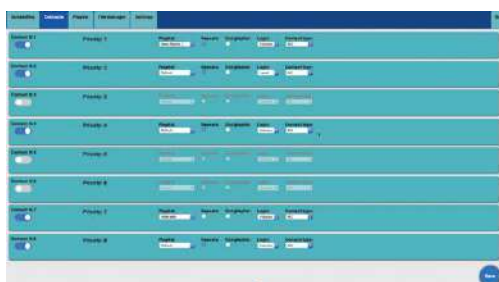
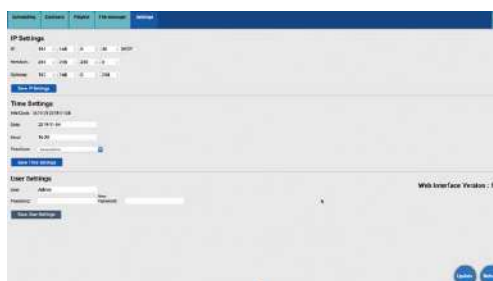



EAN13	CODE
8051272187236	PMA2120
8051272187243	PMA2240
8051272189032	PMA2500



	PMA2120	PMA2240	PMA2500
Descrizione / Description	finale di potenza stereo 100V classe D, a risparmio energetico 100V Class D stereo power amp		
Potenza / Power supply	120W x 2 a 8Ω / 100V	240W x 2 a 8Ω / 100V	500W x 2 a 8Ω / 100V
Ingressi / Inputs	con connettori a morsetti bilanciati / with balanced terminal connectors		
Uscite altoparlanti / Out speakers	8Ω/100V		
Alimentazione / Power supply	230V & 24Vdc	230V & 24Vdc	230V & 24Vdc
Consumo / Consumption	280VA	520VA	1050VA
Dimensioni (LxHxP) / Size (WxHxD)	482x44x420 mm	482x44x420 mm	482x44x420 mm
Peso / Weight	7 kg	7,3 kg	8,2 kg
Standard Rack	1U	1U	1U
Cabinet - Colore / Colour	metal nero, serigrafie arancioni / black, orange serigraphs		

	8051272189889	PSA300MK2
	8051272189896	PSA500MK2



	PSA300MK2	PSA500MK2
Descrizione / Description	Finale di potenza stereo in Classe D, a risparmio energetico / Energy-saving Class D stereo power amp	
Potenza / Power	300W x 2 a 4Ω / 300W x 2 at 4Ω. 180W x 2 a 8Ω / 180W x 2 at 8Ω.	450W x 2 a 4Ω / 450W x 2 at 4Ω 250W x 2 a 8Ω / 250W x 2 at 8Ω
Potenza a ponte / Power bridge	600W a 8Ω	900W a 8Ω
	non accetta collegamenti di impedenze inferiori a 8Ω / does not accept connections of impedances less than 8Ω	
Risposta in frequenza / Frequency response	20-20000Hz +0,5dB	20-20000Hz +0,5dB
Alimentazione / Power supply	115V-230V commu / switch	115V-230V commu / switch
Consumo / Power consumption	600VA	1000VA
Uscita / Output	COMBO Jack bil 6,3mm / XLR bil	COMBO Jack bil 6,3mm / XLR bil
Uscite generali altoparlanti / General speaker outputs	4-16Ω speakon (in dotazione / included)	4-16Ω speakon (in dotazione / included)
Ingressi / Inputs	10KΩ unb, 20KΩ bil, 1V RMS@1Khz	10KΩ unb, 20KΩ bil, 1V RMS@1Khz
Rapporto segnale rumore / Signal to noise ratio	100dB	100dB
Distorsione armonica totale / Total harmonic distortion	0.05% / 1W x CH	0.05% / 1W x CH
Dimensioni (LxHxP) / Size (WxHxD)	482x44x180 mm - 2,6 Kg	482x44x180 mm - 2,8 Kg
Standard Rack	1U	1U
Colore / Colour	nero, serigrafie arancioni / black, orange serigraphs	



finale di potenza stereo 4-16 Ω in Classe D
4-16 Ω Class D stereo power amp

VIVALDI

EAN13	CODE
8051272189018	PS1000
8051272189025	PS3000



	PS1000	PS3000
Descrizione / Description	finale di potenza stereo 4-16 Ω in Classe D, a risparmio energetico 4-16 Ω energy-saving Class D stereo power amplifier	
Potenza / Power	500W x 2 a 4Ω 350W x 2 a 8Ω	1600W x 2 a 4Ω 850W x 2 a 8Ω
Ingressi / IN	program XLR bil	program XLR bil
Uscite / Output	link Out XLR bil	link Out XLR bil
Uscite altoparlanti / Out speakers	4-16Ω speakon (in dotazione / included)	4-16Ω speakon (in dotazione / included)
Alimentazione / Power supply	230V	230V
Dimensioni (LxHxP) / Size (WxHxD)	484x44x375 mm	484x44x375 mm
Peso / Weight	7,5 kg	8,8 kg
Standard Rack	1U	1U
Colore / Colour	nero, serigrafie arancioni / black, orange serigraphs	

8051272180008	PSA4300
8051272188530	PSA4500
8051272188523	PSA6500
8051272188516	PSA8500



	PSA4300	PSA4500	PSA6500	PSA8500
Descrizione / Description	finale di potenza 4 ch / power amplifier 4 ch		finale di potenza 6 ch power amplifier 6 ch	finale di potenza 8 ch power amplifier 8 ch
Potenza / Power	4x350W a / at 4Ω 4x200W a / at 8Ω	4x500W a / at 4Ω 4x350W a / at 8Ω	6x500W a / at 4Ω 6x350W a / at 8Ω	8x500W a / at 4Ω 8x350W a / at 8Ω
Risposta in frequenza / Frequency response	20Hz-20KHz	20Hz-20KHz	20Hz-20KHz	20Hz-20KHz
Ingressi / IN	20KΩ bil/ 10KΩ unb - presa / socket XLR bil		morsetti / clamps	
Uscite altoparlanti / Out speakers	4-16Ω speakon (in dotazione / included)		4-16Ω morsetti / clamps	
Alimentazione / Power supply	220-240V 50/60Hz	220-240V 50/60Hz	220-240V 50/60Hz	220-240V 50/60Hz
Rapporto segnale rumore /	>105dB	>105dB	>105dB	>105dB
Distorsione armonica totale /	0.3%	0.3%	0.3%	0.3%
Dimensioni (LxHxP) / Size (WxHxD)	484x44x375 mm	484x44x375 mm	484x44x430 mm	484x44x430 mm
Peso / Weight	5 kg	8,5 kg	9,3 kg	10,9 kg
Standard Rack	1U	1U	1U	1U
Colore / Colour	nero, serigrafie arancioni / black, orange serigraphs			



EAN13

CODE

8051272183283 **MZ126A**



MZ126A

Descrizione / Description	mixer amplificato multizona, controllo di toni e volume indipendente su ogni zona multi-zone amplified mixer, independent tone and volume control on each zone
Potenza / Power	1x120W + 1x60W (2 zone 120+60W)
Ingressi / IN	4 microfoni miscelabili, 1 aux miscelabile, 3 LINE in commutazione 4 mixable microphones, 1 mixable aux, 3 LINE switched
Uscite altoparlanti / Out speakers	4-8 Ω - 70/100V
Uscita / Output	REC canale 1 e 2 / REC Channel 1 and 2
Alimentazione / Power supply - Consumo / Consumption	230V & 24Vdc - 480VA
Dimensioni (LxHxP) / Size (WxHxD) - Peso / Weight	425x132x355 mm - 15 kg
Standard Rack	3U rack

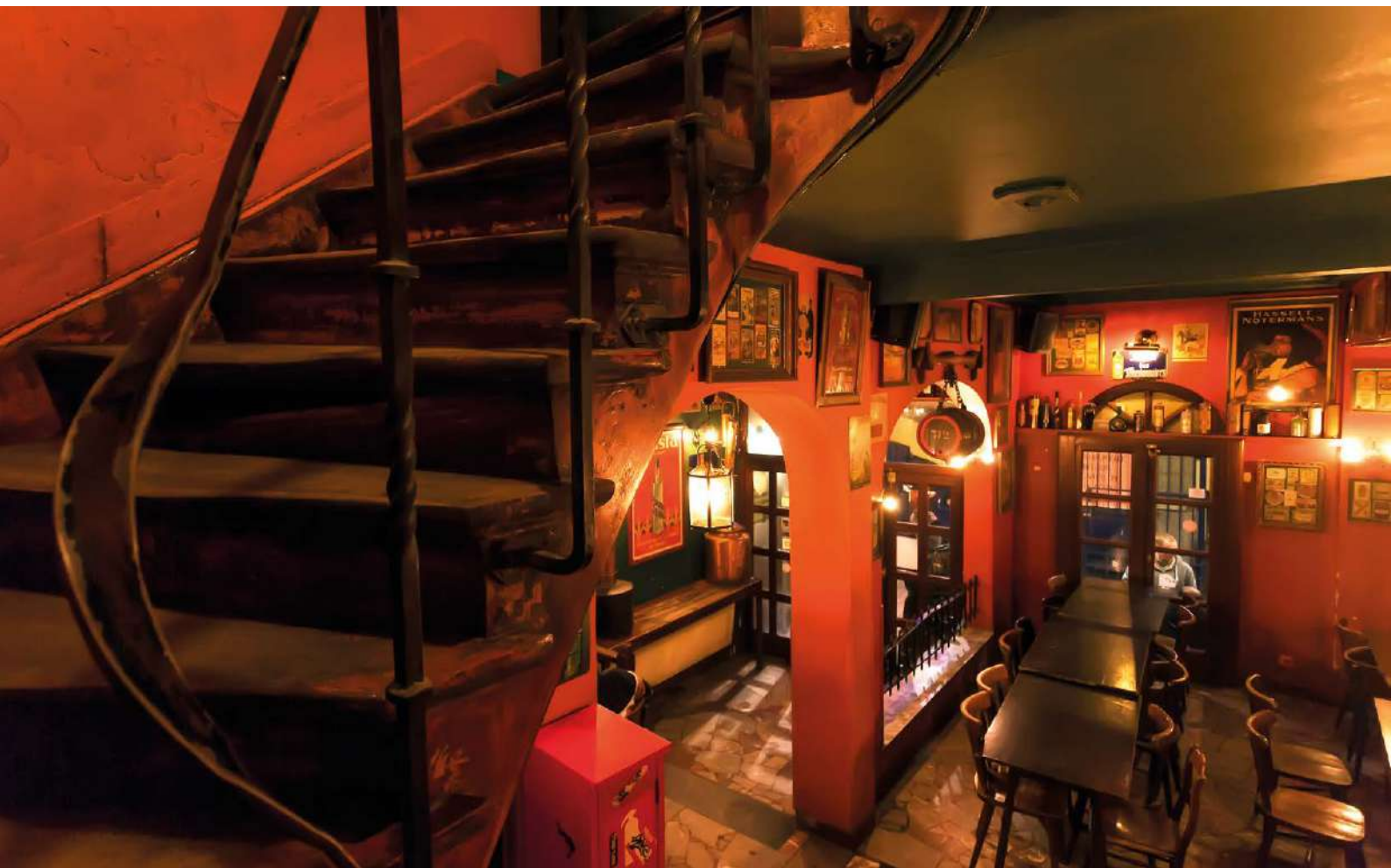



EAN13	CODE
-------	------

 8051272189483	M5EFX
 8051272189490	M8EFX
 8051272189506	M16EFX



M5EFX



M8EFX



M16EFX

	M5EFX	M8EFX	M16EFX
Descrizione / Description	Mixer multieffetto con DSP / Multi-effect mixer with DSP		
Ingressi / In	3 MIC (XLR) 2 stereo LINE Jack bil/unb 6.3mm (20KΩ bil)	5 MIC (XLR) 3 stereo LINE Jack bil/unb 6.3mm (20KΩ bil)	12 MIC (XLR) 4 stereo LINE Jack bil/unb 6.3mm (20KΩ bil)
MP3	Lettore MP3 con display digitale, ingresso USB e lettore SD-CARD MP3 player with digital display, USB input and SD-CARD reader		
REC	Funzione di registrazione su USB o SD-CARD / Recording function to USB or SD-CARD		
FULL DUPLEX	Riproduzione e registrazione da PC/MAC tramite connessione USB Playback and recording from PC/MAC via USB connection		
Risposta in frequenza / Frequency response	20-20.000Hz	20-20.000Hz	20-20.000Hz
GAIN	Gain Range +10 / +60 dB. Livello MAX di ingresso 12dBu @10dB Gain Gain Range +10 / +60 dB. 12dBu Max Input Level @10dB Gain		
Impedenza / Impedance	26KΩ	26KΩ	26KΩ
EQ CH	Alti 12KHz / ±15dB; Medi 2.5KHz / ±15dB; Bassi 80Hz / ±15dB High 12KHz / ±15dB; Medium 2.5KHz / ±15dB; Bass 80Hz / ±15dB		
Uscita MAIN bilanciata / MAIN output balanced	Jack 6.3mm 240Ω	Jack 6.3mm 240Ω	Jack 6.3mm 240Ω
Uscita CUFFIA / headphone output	Jack stereo 6.33 mm	Jack stereo 6.33 mm	Jack stereo 6.33 mm
Freq. di campionamento / Sampling rate	40KHz	40KHz	40KHz
Alimentazione / Power supply	230V 50/60Hz	230V 50/60Hz	230V 50/60Hz
Alimentazione Phantom / Phantom supply	+48V	+48V	+48V
Equalizzatore grafico / Graphic equalizer	stereo a 7 bande sul master / 7-band stereo on the master		
Equalizzatore british / British equaliser	a 3 bande su ogni canale / 3-band on each channel		
Tasto MUTE / MUTE botton	su ogni canale / on every channel	su ogni canale / on every channel	su ogni canale / on every channel
Unità multieffetto / Multi-effect DSP	DSP 24bit integrata con 99 effetti e indicatore di livello a 6 LED Built-in 24bit DSP with 99 effects and 6-LED level indicator		
Altro / More	Funzione di riduzione del rumore per il karaoke / Noise reduction function for karaoke		
Indicatore di livello master / Master level indicator	a 8 LED / 8 LEDs	a 8 LED / 8 LEDs	a 8 LED / 8 LEDs
Dimensioni (LxHxP) Size (WxHxD)	270x85x285 mm	330x90x290 mm	620x60x250 mm



EAN13

CODE

8051272188738

M12X2BT



dotato di registratore USB e ricevitore Bluetooth
provided with USB recorder and Bluetooth receiver

M12X2BT

Descrizione / Description	mixer 13 canali 2 uscite. Dotato di registratore USB e bluetooth mixer 13 channel 2 outputs. Equipped with USB recorder and bluetooth
Ingressi / IN	8 ingressi COMBO XLR/JACK livello microfonico (-20dB) Linea (0dB) con Phantom 48V attivabile 2 ingressi RCA livello linea (0dB) stereo 8 COMBO XLR/JACK inputs microphone level (-20dB) Line (0dB) with activable Phantom 48 2 RCA input stereo line level (0dB)
Player / rec	2x porta USB tipo A (1 per registrazioni/riproduzioni, 1 per riproduzioni). Formati supportati: .wma, .mp3, wav, .flac 1x ricevitore audio Bluetooth 2x USB port type A (1 recording/playing, 1 for playing). Supported formats: .wma, .mp3, wav, .flac 1x Bluetooth audio receiver
Uscite / Out	2 uscite XLR (bil.) con controlli di toni e volumi indipendenti. 2 uscite RCA a livello fisso linea (0dB). 2 XLR outputs (bil.) with independent tone and volume control 2 RCA fixed level line outputs (0dB).
Alimentazione / Power supply	100-240Vca
Toni / Tones	alti e bassi / high and low
Consumo / Consumption	12Wmax
Priorità / Priority ch	ingressi 1 e 2 attivabile enable input 1 and 2
Dimensioni (LxHxD) + Peso Size (WxHxD) + Weight	484x66x250 mm - 2,9 kg
Standard Rack	1,5U



mixer matrice digitale con APP di controllo in lingua Inglese
digital matrix mixer with English language APP management

VIVALDI

EAN13 CODE

8051272180541 MD208



Available on the App Store



IT - Mixer matrice digitale a 20 canali e 8 uscite, con DSP. Controllo manuale e WiFi tramite APP (gratuita disponibile solo in lingua Inglese per iPad)

- > S/PDIF in/out & AES/EBU output
 - > ingressi: 12 MIC/LINE, 2 STEREO LINE INPUT, S/PDIF, USB
 - > 8 FX (2 modulazione, 2 ECHO, 2 riverbero, 2 GEQ)
 - > BUS: L/R + 4 MONO + 4 ST + 1Monitor
 - > NEUTRIK XLR, ALPS faders
 - > USCITA 2.1
- Ingressi Microfonici 12 canali ,XLRs, 4 Combi
 Ingressi di Linea 2 (Stereo) canali, 2x6.5 Stereo Jack
 8 uscite XLR bilanciate assegnabili Stereo Monitor uscita Jack Cuffia uscita Jack
 Fino a 8 effetti assegnabili (riverbero, modulazione, ECHO, 15 bands GEQ)
 Ingresso/Uscite digitali
 Uscite XLR AES/EBU
 Ingresso/uscita S/PDIF (RCA)
 2 Porte USB per riproduzione/registrazione e aggiornamento firmware
 Dimensioni (LxHxP) 484x178x155 mm. Peso 3kg. Standard rack

EN - Digital matrix mixer with 20 channels and 8 outputs, with DSP. Manual control and WiFi via APP (for free only available in English for iPad)

- > S/PDIF in/out & AES/EBU output
 - > inputs: 12 MIC/LINE, 2 STEREO LINE INPUT, S/PDIF, USB
 - > 8 FX (2 modulation, 2 ECHO, 2 reverb, 2 GEQ)
 - > BUS: L/R + 4 MONO + 4 ST + 1Monitor
 - > NEUTRIK XLR, ALPS faders
 - > OUTPUT 2.1
- Microphone Inputs 12 channels ,XLRs, 4 Combi
 Line Inputs 2 (Stereo) Channels, 2x6.5 Stereo Jack
 8 assignable balanced XLR outputs Stereo Monitor Output Jack Headphone Output Jack
 Up to 8 assignable effects (reverb, modulation, ECHO, 15 GEQ bands)
 Digital Input/Outputs
 XLR AES/EBU outputs
 S/PDIF input/output (RCA)
 2 USB ports for playback/recording and firmware update
 Size (WxHxD) 484x178x155 mm. Weight 3kg. Standard rack

Antifeedback

8051272188547 DSP6

IT - Soppressore di feedback microfonico (antilarson). Digitale, automatico, 6CH. Dotato di funzione mixer con gain regolabile 5-14dB. Possibilità di miscelare 1 sorgente Line o Mixer. Alimentazione Phantom 48V. Ingressi JACK/XLR bil. Uscite XLR bil o Linea unb. Alimentazione 220-230V 50/60Hz. Dimensioni (LxHxP) 484x55x220 mm. Peso 3,2Kg. Colore nero.

EN - Microphone feedback suppressor (antilarson). Digital, automatic, 6CH. Equipped with mixer function with adjustable gain 5-14dB. Possibility to mix 1 Line source or Mixer. Power supply Phantom 48V. Inputs JACK/XLR balanced Outputs XLR bal or Line unbal. Power supply 220-230V 50/60Hz. Size (WxHxD) 484x55x220 mm. Weight 3,2Kg. Black color.





EAN13

CODE

8051272189209 VOICE



IT - Kit professionale di comunicazione audio tra due postazioni (operatore ed ospite) composto da una base microfonica da tavolo con diffusore (postazione Operatore) e di un microfono con diffusore per fissaggio a muro o vetro (postazione Ospite).

Possibilità di collegare ad entrambe le postazioni dei diffusori ausiliari (8Ω), esterni, tramite morsetti a vite.

Possibilità di collegare una seconda postazione Operatore (BM1000D). Note: la BM1000D non ha il diffusore integrato. Va quindi abbinato ad un diffusore esterno a 8Ω collegato sulla morsettiera della postazione Operatore.

Utilizzabile ad esempio: postazioni intercomunicanti, bocche di carico, sportelli, interporti, gate di accesso, ecc...

CARATTERISTICHE TECNICHE

POSTAZIONE OPERATORE

- Base microfonica da tavolo pulsante rosso push to talk
- Amplificatore integrato da 30W RMS (60W musicali)
- Microfono a stelo da 46cm, electrete, con collarino luminoso e filtro antipop
- Diffusore integrato da 10W RMS (20W musicali)
- Pulsante di presenza operatore per segnalare la postazione attiva (tramite LED presente sulla postazione Ospite)
- Pulsante di mute per permettere all'operatore di disattivare l'audio verso la postazione Ospite e gli eventuali diffusori collegati
- LED attivazione funzione mute
- LED di presenza operatore
- LED Mic (chiamata in corso)
- 1x mini jack, per auricolari con microfono
- 1x Line Aux IN (sorgente locale)
- 1x contatto in ingresso per abilitazione ingresso potenza.
- Regolazione volume di ascolto
- Connessione a morsetto, uscita di Linea per diffusore esterno (8 Ω)
- Alimentazione tramite AL0 24V, fornito in dotazione
- Dimensioni base microfonica (LxHxP): 170x130x50 mm
- Microfono (L) 460 mm
- Peso 0,4Kg.

POSTAZIONE OSPITE

- Di forma rotonda
- Diffusore integrato da 10W RMS (20W musicali)
- Connessione a morsetto, uscita di Linea per diffusore esterno (8Ω)
- LED bicolore (verde presenza operatore interno e rosso assenza operatore interno)
- Ingresso contatto per chiamata operatore
- Sistema di fissaggio a muro o vetro
- Alimentazione tramite postazione operatore
- Connessione alla postazione operatore tramite cavo CAT5/6 UTP
- Dimensioni (DxP): 100x45 mm.

EN - Professional audio communication kit between two workstations (operator and guest) consisting of a table microphone base with speaker (Operator station) and a microphone with speaker for wall or glass fixing (Guest station).

Possibility to connect to both stations of the auxiliary speakers (8Ω), external, through screw terminals.

Possibility to connect a second Operator station (BM1000D). Note: The BM1000D does not have the built-in speaker. It must therefore be combined with an external 8 Ω speaker connected to the terminal block of the Operator station.

Usable for example: intercommunicating stations, loading ports, doors, interports, access gates, etc ...

SPECIFICATIONS

OPERATOR STATION

- Desk microphone base red push to talk button
- Integrated 30W RMS amplifier (60W music)
- 46cm stem microphone, electrete, with bright collar and pop filter
- Built-in 10W RMS speaker (20W music)
- Operator presence button to signal the active station (via LED on the Guest station)
- Mute button to allow the operator to mute the audio to the Guest station and any connected speakers
- LED mute function activation
- Led present operator
- LED Mic (talk in progress)
- 1x mini jack, for earphones with microphone
- 1x Line Aux IN (local source)
- 1x incoming contact for power input
- Listening volume adjustment
- Clamp connection, line output for external speaker (8Ω)
- Power supply via AL0 24V, included
- Microphone base Size (WxHxD): 170x130x50 mm
- Microphone (L) 460 mm
- Weight 0,4Kg.

GUEST STATION

- Round shape
- Built-in 10W RMS speaker (20W music)
- Clamp connection, line output for external speaker (8Ω)
- Two-tone LED (green presence of internal operator and red absence of internal operator)
- Input contact for operator
- Wall or glass fixing system
- Power supply via operator station
- Connection to the operator station via CAT5/6 UTP cable
- Size (DxD): 100x45 mm.

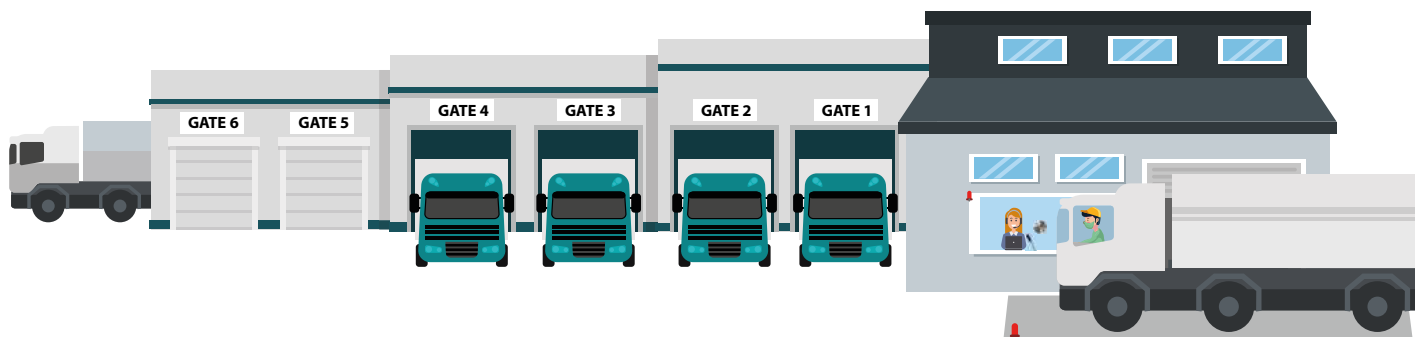

Esempio di applicazione su postazioni intercomunicanti, bocche di carico, sportelli, interporti, gate di accesso, ecc...
Possibilità di collegare ad entrambe le postazioni dei diffusori ausiliari (8Ω), esterni, tramite morsetti a vite.
Possibilità di collegare una seconda postazione Operatore (BM1000D). Note: la BM1000D non ha il diffusore integrato.
Va quindi abbinata ad un diffusore esterno a 8Ω collegato sulla morsettiera della postazione Operatore.

Example of application on intercommunicating stations, loading ports, doors, interports, access gates, etc ...
Possibility to connect to both stations of the auxiliary speakers (8Ω), external, through screw terminals.
Possibility to connect a second Operator station (BM1000D). Note: The BM1000D does not have the built-in speaker.
It must therefore be combined with an external 8Ω speaker connected to the terminal block of the Operator station.

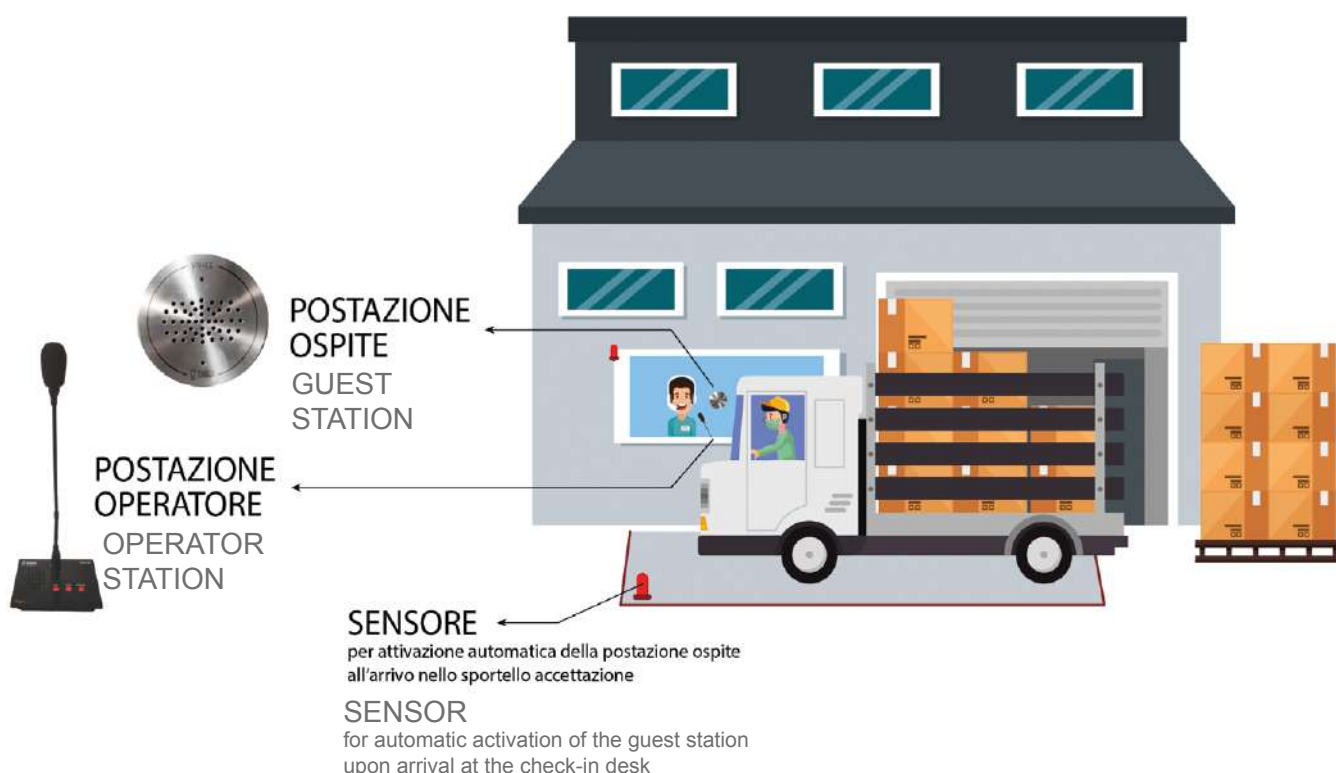



EAN13

CODE

**Interfono bidirezionale
Two-way intercom**



8051272189391

INCOMK2



IT - Kit interfono bidirezionale via cavo, composto da microfono da tavolo/parete, altoparlante da tavolo/parete e stazione di chiamata separata

Microfono Cardiode Electret
Pulsante accensione
Pulsante microfono ON/OFF
Regolazione Volume
Lunghezza Asta microfonica 350 mm (L)
Dimensioni base microfonica 135x50x150mm (LxHxD)
Dimensioni microfono per ospite 30X16 mm (DxH)
Dimensioni altoparlante per ospite 90x75x25 (LxHxD)
Lunghezza cavo microfono per ospite 2,8mt (in dotazione)
Colore grigio antracite. Alimentatore in dotazione.
Peso 0,8 Kg

EN - Two-way cable intercom kit, of table/wall microphone, desk/wall speaker and separate call station
Electret Cardioid Microphone
Power button
Microphone button ON/OFF
Volume Adjustment
Microphone rod length 350 mm (L)
Microphone base Size 135x50x150mm (WxHxD)
Microphone Size for guest 30X16 mm (DxH)
Speaker Size per guest 90x75x25 (WxHxD)
Microphone cable length for guest 2.8mt
Anthracite grey colour. Power supply (included).
Weight 0,8 Kg

**Microfoni e Basi microfoniche
Microphones and Microphone Bases**

8051272188325

BM100D



IT - Base microfonica da tavolo (predisposta per appoggio o incasso) con DIN-DON.
Ideale per negozi, supermercati, fabbriche, scuole, centri sportivi...
LED Power.
LED Busy.
LED Mic.
Pulsante **push to talk**.
Microfono a stelo da 46cm, electrete, con collarino luminoso e filtro antipop.
Contatto in uscita per attivazione priorità (evacuazione, pubblicitari...)
Segnale in uscita regolabile 10÷200mV.
Ingresso di linea per sorgente ausiliaria.
Ingresso micro USB per inserimento di CHIME personalizzati (DIN-DON, campanella, ...)
Selettore per attivazione segnale Chime prima della chiamata.
Selettore livello di uscita LINEA (0V a 800mV) o MIC (da 0 a 10mV).
Alimentazione 12V.
Alimentatore DC e cavo intestato XLR da 5mt, a corredo.
Dimensioni base (LxHxD): 170x130x50 mm.
Microfono (L) 460 mm.
Peso 1,357 Kg.

EN - Desktop microphone base (prepared for shelf or recessed) with DIN-DON.
Ideal for shops, supermarkets, factories, schools, sports centers...
LED Power.
Led Busy.
LED Mic.
Push to talk button.
46cm stem microphone, electrete, with luminous collar and pop filter.
Outgoing contact for priority activation (evacuation, advertising...)
Adjustable output signal 10÷200mV.
Line input for auxiliary source.
Micro USB input for insertion of custom CHIME (DIN-DON, bell, ...) Selector for Chime signal activation before the call.
LINE output level selector (0V to 800mV) or MIC (0 to 10mV).
Power supply 12V.
DC power supply and 5mt XLR cable, included.
Base dimensions (WxHxD): 170x130x50 mm.
Microphone (L) 460 mm.
Weight 1,357 Kg.



EAN13 CODE



PLS65

PL61

8051272185553 **PL61** nero / black

IT - Microfono flessibile per BM5000. Electret supercardioide (canna di fucile). Asta flessibile/rigido/flessibile. Risposta in frequenza 50-16000 Hz. Sensibilità (-54 dB +3dB) Connettore XLR. Dimensioni 600 mm (H). Peso 0,18 Kg.

EN - Flexible microphone for BM5000. Electret supercardioid (gunmetal). Flexible/rigid/flexible rod. Frequency response 50-16000 Hz. Sensitivity (-54 dB +3dB) XLR connector. Size 600 mm (H). Weight 0,18 Kg.

8051272186987 **PLS65** nero / black

IT - Microfono flessibile per BM5000. Electret cardioide. Anti-Shock. Asta flessibile/rigido/flessibile. Risposta in frequenza 80-16000 Hz. Sensibilità (-66 dB +3dB). Impedenza 200 Ω. Connettore XLR. Dimensioni 550 mm (H). Peso 0,2 Kg.

EN - Flexible microphone for BM5000. Cardioid electret. Anti-Shock. Flexible/rigid/flexible rod. Frequency response 80-16000 Hz. Sensitivity (-66 dB +3dB). Impedance 200 Ω. XLR connector. Size 550 mm (H). Weight 0,2 Kg.



BM5000

8051272183627 **BM5000** nero / black

IT - Base microfonica da tavolo con pulsante On-Off. Ideale per sale riunioni, conferenze, altari/pulpiti. Per asta PLS65, PL61. Connettore XLR Maschio 3 poli, (cavo da ordinare a parte). Dimensioni 120x50x150 mm (LxHxP). Peso 0,92 Kg.

EN - Desktop microphone base with On-Off button. Ideal for meeting rooms, conferences, altars/pulpits. For rode PLS65, PL61. XLR Male connector 3 poles, (cable not included). Size 120x50x150 mm (WxHxD). Weight 0,92 Kg.

8051272185522 **PG58**



IT - Microfono dinamico di qualità professionale. Progettato con capsula microfonica incorporata. Ideale per canto, utilizzabile anche per parlato. Risposta in frequenza: 60Hz - 15kHz Diagramma polare: Cardioide Trasduttore: Dinamico (moving coil) Magnete: Neodimio per un elevato livello di uscita Shockmount interno per ridurre il rumore del maneggiamento Interruttore On/Off Robusta griglia con maglia in acciaio Filtro antipop integrato Supporto per asta in dotazione

EN - Professional quality dynamic microphone. Designed with built-in microphone capsule. Ideal for singing, also usable for speech. Frequency response: 60Hz - 15kHz Polar diagram: Cardioid Transducer: Dynamic (moving coil) Magnet: Neodymium for high output level Internal shockmount to reduce handling noise On/Off Switch Sturdy grid with steel mesh Built-in pop filter Rod holder included

8051272186581 **U891RB** nero / black

8051272186598 **U891RW** bianco / white



IT - Microfono da superficie boundary Unidirezionale 180°x60° Risposta in frequenza 30-20.000 Hz Max input sound level 130dB SPL, 1Khz Impedenza 200 Ω Connettore Spina Mini XLR 3P Alimentazione phantom 11-52Vdc, 4mA Touch on/off Campo di utilizzo 1/3 metri Dimensioni 108x23x84 mm (LxHxP) Peso 0,26Kg Cavo in dotazione.

EN - Boundary Surface Microphone Unidirectional 180°x60° Frequency response 30-20,000 Hz Max input sound level 130dB SPL, 1Khz Impedance 200 Ω Connector Plug Mini XLR 3P Phantom power supply 11-52Vdc, 4mA Touch on/off Field of use 1/3 meters Size 108x23x84 mm (WxHxD) Weight 0,26Kg Cable included.



EAN13

CODE



8051272189926

CV101B nero antracite / black anthracite



8051272189919

CV101W bianco / white

IT - Attenuatore di volume per linee di altoparlanti 100V.
Potenza 100W.
Ingresso bypass dell'attenuazione tramite relè 24V.
10 posizioni + OFF.
Predisposto per 503.

EN - Volume attenuator for 100V speaker lines.
Power 100W.
Bypass input by relè 24V.
10 positions + OFF.
Ready for box 503.

Ordinare l'adattatore per la serie civile desiderata (vedi pag. 54-55)
Non compatibile con AD15 e con AD16

Order the adapter for the desired civil series (see p.54-55)
Not compatible with AD15 and AD16



8052015550133

VE300A



IT - Kit trasmettitore Audio over CAT 5e/6 per la trasmissione di segnali digitali ottici e coassiali fino a distanze di 300mt (48kHz), 150mt (96kHz) o 100mt (192kHz). Il ricevitore DAC converte anche il segnale digitale (coax/toslink ottico) in uscita 2CH analogica stereo.
Trasmettitore: DIGITAL INPUT COAX-TOSLINK OUTPUT RJ45
Ricevitore: INPUT RJ45 DIGITAL OUTPUT COAX-TOSLINK ANALOG OUTPUT STEREO 3,5MM (Jack) Formati supportati LPCM, DTS, DOLBY DIGITAL e DOLBY DIGITAL PLUS quando usati in ingresso/uscita digitale diretto.
Frequenza di campionamento: 32kHz, 44.1kHz, 96Khz e 192kHz fino a risoluzione 24-bit. Colore nero. Peso 0,4Kg. Dimensioni 76x64x28 mm (LxHxD).

EN - Audio over CAT 5e/6 transmitter kit for the transmission of optical and coaxial digital signals up to distances of 300mt (48kHz), 150mt (96kHz) or 100mt (192kHz). The DAC receiver also converts the digital signal (coax/optical toslink) into stereo analog 2CH output.
Transmitter: DIGITAL INPUT COAX-TOSLINK OUTPUT RJ45
Receiver: INPUT RJ45 DIGITAL OUTPUT COAX-TOSLINK ANALOG OUTPUT STEREO 3.5MM (Jack). Supported formats LPCM, DTS, DOLBY DIGITAL and DOLBY DIGITAL PLUS when used in direct digital input/output. Sampling rate: 32kHz, 44.1kHz, 96Khz and 192kHz up to 24-bit resolution. Black color. Weight 0,4Kg. Size 76x64x28 mm (WxHxD).



8052015551178

VEOF4K



IT - Kit optical Fiber extender (ricevitore+trasmettitore). Può trasmettere segnali HDMI fino al 4K2K@60Hz 4:4:4.; fino a 10km (su fibra monomodale) Controllo IR bidirezionale e il pass-through RS-232. Compatibile con HDMI 2.0b, HDCP 2.2 e DVI 1.0. Supporta la larghezza di banda video da 18 Gbps Risoluzione video fino a 4K2K@50/60Hz 4:4:4 Dimensioni R/T (LxHxD): 134x18x68 mm. Peso trasmettitore 0,28Kg + Ricevitore: 0,28Kg.

EN - Optical Fiber extender kit (receiver+transmitter). It can transmit HDMI signals up to 4K2K@60hz 4:4:4. ; up to 10km (on single mode fiber) Bidirectional IR control and RS-232 pass-through. Compatible with HDMI 2.0b, HDCP 2.2 and DVI 1.0. It supports 18 Gbps video bandwidth Video resolution up to 4K2K@50/60hz 4:4:4 Dimensions R/T (lxhxp): 134x18x68 mm. Transmitter weight 0.28kg + Receiver: 0.28kg.

8051272186970

MPR2



IT - Preamplificatore a 2 canali con ingresso microfonico bilanciato e linea stereo. Regolazione volume ingresso stereo e guadagno in uscita. Phantom power (30V) su ingresso microfono. Funzione talk-over microfono su ingresso linea. 1 ingresso microfonico XLR bilanciato e 1 ingresso Jack 6,3mm stereo aux. Led di stato. Peso 0,6Kg.

EN - 2 Channels preamplifier with bal. Microphone input and stereo line. Input volume adjustable and gain output Phantom power (30V) on microphone input. Microphone Talk-over function on line input. 1x XLR bal. Microphone input and 1x Jack input 6,3mm stereo aux. Status Led Weight 0,6 Kg



EAN13

CODE



8051272189988 **PRD1**



IT - Partitore resistivo duale.
Ingresso di potenza 100V o 8 Ω.
Uscita di segnale Linea.
Trimmer di regolazione volume in uscita.
Standard DIN (1 modulo).
Dimensioni 18x90x63 (LxHxP) mm.
Peso 0,1Kg.

EN - Dual return divider.
Power input 100V or 8 Ω.
Line signal output.
Output volume adjustment trimmer.
DIN standard (1 module).
Size 18x90x63 (LxHxD) mm.
Weight 0,1Kg.



8051272189841 **DA8**



IT - Distributore di segnali audio a doppia modalità:
- 1 ch input e 8 uscite bilanciate
- 2 ch input e 4 uscite bilanciate
Ground Lift attivabile per ogni morsetto d'uscita tramite DIP switch.
8 trimmer di controllo per attenuazione uscite.
Rapporto segnale 1:1.
Alimentazione 12-36Vdc tramite AL2B (da ordinare a parte).
Standard DIN (6 moduli).
Dimensioni 106x90x63 mm (LxHxP).
Peso 0,1 Kg.

EN - Dual Mode Audio Signal Distributor:
- 1 ch input and 8 balanced outputs
- 2 ch input and 4 balanced outputs
Ground Lift can be activated for each output clamp via DIP switch.
8 control trimmers for output attenuation.
1:1 signal ratio.
Power supply 12-36Vdc via AL2B (not included).
DIN standard (6 modules).
Size 106x90x63 mm (WxHxD).
Weight 0,1 Kg.

8051272188004 **FGA22**



IT - Trasformatore che adatta 1 uscita 4/8Ω a 1 segnale di linea.
2xPresa PIN.
Range di frequenza 20-30000HzIN/OUT impedance 120Ω/200Ω.
Lunghezza cavo 2x14 cm.
Peso 0,25Kg.

EN - Transformer that adapts 1 output 4/8Ω to 1 line signal.
2xPIN socket.
Frequency range 20-30000HzIN/OUT impedance 120Ω/200Ω.
Cable length 2x14 cm.
Weight 0,25Kg.

8051272184167 **ISL2**



IT - Isolatore anello di massa.
Trasformatore 1:1.
Ingresso 2xRCA presa oro.
Uscita 2xRCA spina oro.
Lunghezza cavo 2x6 cm.
Peso 0,25Kg.

EN - Ground loop insulator.
Transformer 1:1.
Input 2xRCA gold socket.
Output 2xRCA gold plug.
Cable length 2x6 cm.
Weight 0,25Kg.

8051272185539 **PHANTOM2**



IT - Alimentatore Phantom 48V a 2 canali.
Per 1/2 microfoni a condensatore.
Ingressi ed uscite frontali XLR maschio/femmina.
Peso 1Kg.

EN - Phantom 48V Power Supply 2 channels.
For 1/2 condenser microphones.
XLR male/female front inputs and outputs.
Weight 1Kg.











8051272186383 **SM3**







IT - Sommatore microfonico a 3 ingressi. Contatti XLR simmetrici. Gamma di frequenze 20-20000Hz. Adatto anche per microfoni con alimentazione Phantom. Dimensioni 125x55x77mm. Peso 0,57Kg.

EN - Multi microphone with 3 inputs. Symmetrical XLR contacts. Frequency range 20-20000Hz. Also suitable for microphones with Phantom power supply. Size 125x55x77mm. Weight 0,57Kg.

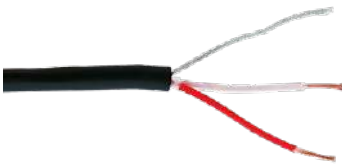
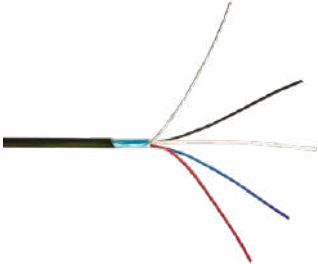
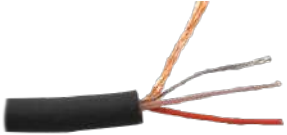

		EAN13	CODE
 <p>ST3</p>	 <p>SUCS</p>	8051272186406	ST3
		<p>IT - Supporto treppiede da pavimento per: - SOUND8/8A, SOUND12/12A, POWER10A/12A - in abbinamento al SUCS per CS10T, CS20T, CS40/CS40T Dotato di sistema di bloccaggio. Dimensioni (chiuso) 130x970x130 mm (LxHxP). Altezza aperto/max estensione 1940mm. Peso 2,7 Kg. Materiale metallo verniciato nero. Portata 30Kg max.</p>	<p>EN - Floor tripod stand for: - SOUND8/8A, SOUND12/12A, POWER10A/12A - in combination with SUCS for CS10T, CS20T, CS40/CS40T Equipped with locking system. Size (closed) 130x970x130 mm (WxHxD). Height open/max extension 1940mm. Weight 2,7 Kg. Black painted metal material. Capacity 30Kg max.</p>
 <p>ST5</p>	 <p>AF3</p>	8051272186963	ST5
		<p>IT - Supporto da pavimento treppiede per microfono gooseneck. Dimensioni treppiede minima 960 mm, massima 1600 mm (H) Peso 1,7 Kg. Materiale metallo verniciato nero</p>	<p>EN - Floor Tripod Stand for Gooseneck Microphone Minimum tripod size 960 mm, maximum 1600 mm (H) Weight 1,7 Kg. Black painted metal material</p>
		8051272186956	AF3
		<p>IT - Adattatore filettato XLR 3P per supporto microfonico treppiede ST5.</p>	<p>EN - XLR 3P threaded adapter for ST5 tripod microphone stand.</p>
		8051272180282	STANDGFC
		<p>IT - Supporto a giraffa da pavimento treppiede per microfono/radiomicrofono a mano Kit composto da: - stand da pavimento treppiede - braccio a giraffa - clip per microfono Dimensioni asta con clip 860 mm (L) Dimensioni treppiede minima 960 mm, massima 1600 mm (H). Peso 2,1 Kg Materiale metallo verniciato nero</p>	<p>EN - Tripod floor stand for microphone/ handheld radio microphone Kit includes: - tripod floor stand - giraffe arm - microphone clip Clip rod size 860 mm (L) Minimum tripod size 960 mm, maximum 1600 mm (H) Weight 2,1 Kg. Black painted metal material</p>
		8052015551109	STANDGFR
		<p>IT - Supporto a giraffa da pavimento con pesante base rotonda, per microfono/radiomicrofono a mano Kit composto da: - stand da pavimento con base toronda - braccio a giraffa - clip per microfono Dimensioni asta con clip minima 450 mm, massima 730mm (L) Dimensioni treppiede minima 760 mm, massima 1380 mm (H) Peso 3,1 Kg. Materiale metallo verniciato nero</p>	<p>EN - Giraffe floor stand with heavy round base, for hand-held microphone/radiomicrophone Kit consisting of: - floor stand with round base - giraffe arm - microphone clip Tripod dimensions with clip minimum 450 mm, maximum 730 mm (L) Tripod dimensions minimum 760 mm, maximum 1380 mm (H) Weight 3.1 Kg. Material black painted metal</p>
 <p>STANDSK</p>	 <p>AF2</p>	8051272186413	STANDSK
		<p>IT - Supporto da tavolo per microfono/ radiomicrofono a gelato. Kit composto da: - base da tavolo rotonda (140mm D) - asta flessibile con connettore filettato (230mm H) - clip per microfono. Dimensioni 360x140 mm (HxD). Peso 1,5Kg.</p>	<p>EN - Table support for microphone/ handheld radio microphone. Kit includes: - round table base (140mm D) - flexible rod with threaded connector (230mm H) - microphone clip Size 360x140 mm (HxD). Weight 1,5Kg.</p>
 <p>STANDSK</p>	 <p>AF2</p>	8051272189674	AF2
		<p>IT - Adattatore filettato 3/8" - 5/8" per supporto microfonico SU30 su STANDSK.</p>	<p>EN - 3/8" - 5/8" threaded adapter for SU30 microphone holder on STANDSK.</p>



	EAN13	CODE	
	8051272185270	MICRO2.50 50 mt	
	8051272185256	MICRO2.100 100 mt	
	8051272185263	MICRO2.200 200 mt	
		IT - Matassa di cavo microfonico 3mm (diametro esterno).	EN - Skein of microphone cable 3mm (outer diameter).
	8051272185317	MICRO4.50 50 mt	
	8051272185294	MICRO4.100 100 mt	
	8051272185300	MICRO4.200 200 mt	
		IT - Cavo microfonico 3,7mm 4 conduttori (diametro esterno).	EN - 3.7mm Microphone Cable 4 conductors (outer diameter).
	8051272185201	LINK	
		IT - Cavo schermato 2x0,25 mm per collegamento di microfoni o basi microfoniche. Fornito a metro o matassa.	EN - Shielded cable 2x0.25 mm for connecting microphones or microphone bases. Included by meter or skein.
	8051272185232	LINKBP	
		IT - Cavo microfonico 2+schermo 6mm. Bassa perdita. Fornito a metro o matassa.	EN - Microphone cable 2+ shielding 6mm. Low loss. Included by meter or skein.
	8051272185225	LINK4BP	
		IT - Cavo microfonico 2x2x0,22 twistato. Bassa perdita. Fornito a metro o matassa.	EN - 2x2x0.22 twisted microphone cable. Low loss. Included by meter or skein.
	8051272185287	MICRO220	
		IT - Cavo segnale + alimentazione per diffusori attivi, diametro 12mm (diametro esterno) Fornito a metro o matassa.	EN - Signal cable + power supply for active speakers, diameter 12mm (outer diameter) Included by meter or skein.
	8051272183665	C01	
		IT - Kit composto da: nr. 01 cavo da 1,5mt con connessioni mini jack 3,5 mm - RCA STEREO nr. 01 alimentatore per USB	EN - Kit of: Nr. 01 1.5mt cable with 3.5mm mini jack connections - RCA STEREO Nr. 01 usb power supply



EAN13	CODE
-------	------

Cavi microfonici
Microphone cables



8051272183702	CIM1X 1 mt
8051272183733	CIM3X 3 mt
8051272183757	CIM5X 5 mt
8051272183689	CIM10X 10 mt
8051272183696	CIM15X 15 mt
8051272183719	CIM20X 20 mt
8051272183726	CIM30X 30 mt

IT - Cavi Microfonici intestati
XLR-XLR

EN - Microphone cables XLR-XLR
headed

Trasformatori 100V
100V Transformers

8051272188448	TR5 5 W - 10 peak
8051272186543	TR6 3/6 W - 12 peak
8051272186499	TR10 2,5/5/10 W - 20 peak
8051272186505	TR15 1/2/4/7,5/15 W - 30 peak
8051272186529	TR30 8/16/32 W - 64 peak
8051272188578	TR50 10/20/50 W - 100 peak

IT - Trasformatore per il
collegamento di diffusori su linee
100V.

EN - Transformer for connecting
speakers on 100V lines.



TR5

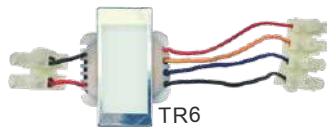

TR6

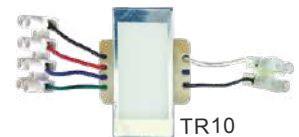

TR10



TR15







TR30



TR50





EAN13
CODE
Armadi rack vuoti
Empty rack cabinets

	8052015550355	RACK12U 12 unit - (LxHxP) 600x643x600 mm
	8052015550362	RACK22U 22 unit - (LxHxP) 600x1166x600 mm
	8052015550379	RACK32U 32 unit - (LxHxP) 600x1610x600 mm
	8052015550386	RACK42U 42 unit - (LxHxP) 600x2055x600 mm

IT - Mobile metallico a norme rack. Lamiera d'acciaio con una forte capacità di carico, verniciata a polvere. Composto da 2 fianchi, tetto, fondo, porta con chiave, ruote, pannello di chiusura posteriore. Fianchi laterali smontabili con chiusura a chiave. IP40. Messa a terra, kit di viti per il montaggio degli accessori incluse. Colore: nero RAL9005.

EN - Metal cabinet to standard rack. Steel sheet with a strong load capacity, powder coated. Composed of 2 sides, roof, bottom, door with key, wheels, rear locking panel. Removable side panels with key lock. IP40. Grounding, kit includes screws for mounting accessories included. Color: black RAL9005.

Armadi rack cablati
Wired rack cabinets

	8052015550393	RACK12UC 12 unit - (LxHxP) 600x643x600 mm
	8052015550409	RACK22UC 22 unit - (LxHxP) 600x1166x600 mm
	8052015550416	RACK32UC 32 unit - (LxHxP) 600x1610x600 mm
	8052015550423	RACK42UC 42 unit - (LxHxP) 600x2055x600 mm

IT - Mobile metallico a norme rack. Lamiera d'acciaio con una forte capacità di carico, verniciata a polvere. Composto da 2 fianchi, tetto, fondo, porta con chiave, ruote, pannello di chiusura posteriore. Fianchi laterali smontabili con chiusura a chiave. IP40. Messa a terra, kit di viti per il montaggio degli accessori incluse. Fornito montato, cablatto, programmato e collaudato. Completo di tutti gli accessori cavi, connettori, ecc... occorrenti alla perfetta installazione e cablaggio delle apparecchiature previste in offerta. Prezzo comprensivo di manodopera per il montaggio, la programmazione, la taratura dei dispositivi installati ed il collaudo in fabbrica. Fornito con documentazione relativa e manuali. Colore: nero RAL9005.

EN - Metal cabinet to standard rack. Steel sheet with a strong load capacity, powder coated. Composed of 2 sides, roof, bottom, door with key, wheels, rear locking panel. Removable side panels with key lock. IP40. Grounding, kit includes screws for mounting accessories included. Included assembled, wired, programmed and tested. Complete with all the cable accessories, connectors, etc ... necessary for the perfect installation and wiring of the equipment provided on offer. Price including labor for assembly, programming, calibration of installed devices and factory testing. Included with related documentation and manuals. Color: black RAL9005.



EAN13	CODE
	Pannelli rack Panels rack
8051272185577	PNR1/2U 1/2U
8051272185614	PNR1U 1U
8051272185621	PNR1UA 1U - aerato / aerated
8051272185652	PNR2U 2U
8051272185669	PNR2UA 1U - aerato / aerated
8051272185683	PNR3U 3U
8051272185706	PNR4U 4U



IT - Pannello di chiusura per mobili rack in metallo

EN - Closing panel for rack furniture made of metal.

Accessori per armadi rack
Rack cabinets accessories

	8052015550478	CR3U	<p>IT - Cassetto contenitore per armadi rack. Estraibile, con serratura. 3U. Fornito con viti per il montaggio. Dimensioni (LxHxP) 485x134x480 mm. Peso 10Kg. Colore nero RAL 9005.</p>	<p>EN - Storage drawer for rack cabinets. Removable, with lock. 3U. Included with screws for mounting. Size (WxHxD) 485x134x480 mm. Weight 10kg. Black color RAL 9005.</p>
---	---------------	-------------	--	---



	8051272182989	PSK	<p>IT - Supporto rack a vassoio per l'alloggiamento a rack di apparecchiature. Colore nero RAL 9005.</p>	<p>EN - Tray rack support for rack equipment. Black color RAL 9005.</p>
---	---------------	------------	---	--



	8051272185454	P4RC	<p>IT - Kit pannello in metallo, 2 unità rack, 4 fori per l'alloggiamento di prodotti standard 503. Colore nero RAL 9005. Peso: 0,40 kg. Fornito con adattatori AD2B e supporti portafrutto.</p>	<p>EN - Metal panel kit, 2 rack units, 4 holes for housing standard box 503 products. Black color RAL 9005. Weight: 0.40 kg. Adapters AD2B and plate adapters included.</p>
--	---------------	-------------	---	--

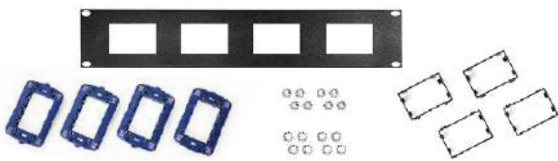

	8051272185720	PNRMT16	<p>IT - Pannello in metallo, 2 unità rack, completo di accensioni con magnetotermici 16A, fusibile di protezione e prese di servizio. Colore nero RAL 9005.</p>	<p>EN - Metal panel, 2 rack units, complete with ignitions with 16A magneto thermic, protective fuse and service sockets. Black color RAL 9005.</p>
--	---------------	----------------	--	--

	8051272189094	P24D	<p>IT - Pannello 24 moduli per alloggiamento a rack di prodotti da barra DIN. Standard rack 3U. Colore nero RAL 9005. Peso 0,80Kg.</p>	<p>EN - 24-module panel for rack mounting of DIN bar products standard 3U rack Colour: RAL9005 Black Weight: 0,80 Kg</p>
---	---------------	-------------	---	---





	EAN13	CODE	
	8051272185430	P1G	<p>IT - Coppia di alette per alloggiamento a rack. Colore nero RAL9005. Peso: 0,14 kg.</p> <p>EN - Lateral flaps pair for rack installation. Black color RAL9005. Weight: 0.14 kg.</p>
	8051272185447	P2G	<p>IT - Coppia di alette per alloggiamento a rack. Colore RAL 9005. Peso 0,33Kg.</p> <p>EN - Lateral flaps pair for rack installation. Black color RAL9005. Weight: 0,33 kg.</p>
	8051272181302	SR500	<p>IT - Coppia di supporti laterali (guide) rack, da 500 mm, per alloggiamento a rack. Colore nero RAL9005.</p> <p>EN - Lateral flaps pair (guides) racks, 500 mm, for rack installation. Black color RAL9005.</p>
	8051272183832	DADIRACK	<p>IT - Dadi in gabbia per mobile rack. Confezione 100pz.</p> <p>EN - Cage nuts for mobile racks. Pack 100pcs.</p>
	8051272186277	RONDELLERACK	<p>IT - Rondelle per mobile rack. Confezione 100pz.</p> <p>EN - Washers for mobile racks. Pack 100pcs.</p>
	8051272186710	VITIRACK	<p>IT - Viti per mobile rack 6x25mm. Confezione 100pz.</p> <p>EN - Screws for mobile rack 6x25mm. Pack 100pcs.</p>
	8051272185546	PIEDERACK	<p>IT - Piede regolabile a vite per mobile rack. Confezione 4pz. Peso: 0,20 kg.</p> <p>EN - Adjustable screw foot for mobile rack. Pack 4pcs. Weight: 0.20 kg.</p>
	8051272186284	RUOTEG	<p>IT - Kit 4 ruote grandi per mobile rack, 2 con freno e 2 senza freno</p> <p>EN - Kit 4 large wheels for mobile rack, 2 with brake and 2 without brake</p>



EAN13

CODE



8052015550928

WSR4



8052015550935

RG58U50.1 Cavo RG58U 50Ω. Diametro 5mm.



Cavo fornito al metro,
da ordinare a parte

Cable supplied by the metre,
to be ordered separately



IT - Distributore d'antenna per 4 trasmettitori wireless (radiomicrofoni) + 1 rilancio per secondo distributore. Alimentazione phantom.

Ampia gamma di frequenze, copre tutto il Punto di frequenza wireless UHF. Antenna direzionale a banda larga. Antenna direzionale, diminuire l'interferenza con altri dispositivi. Impedenza di ingresso dell'antenna: 50Ω (cavo RG58U50.1 da ordinare a parte). Impedenza di uscita dell'antenna: 50Ω (cavo RG58U50.1 da ordinare a parte).

Preso di ingresso dell'antenna: TNC. Preso di uscita dell'antenna: TNC. Guadagno: 3 dB. Banda: 200 MHz. Alimentazione: CC 12-18 V 300 mA. Dimensioni (LxHxP): 410x45x160 mm. Peso: 2 kg. Distanza massima tra distributore ed antenna: 350mt. Amplificatori d'antenna.

Impedenza di ingresso dell'antenna: 50Ω (cavo RG58U50.1 da ordinare a parte). Impedenza di uscita dell'antenna: 50Ω (cavo RG58U50.1 da ordinare a parte). Preso di ingresso dell'antenna: TNC. Preso di uscita dell'antenna: TNC. Guadagno: 13 dB. Banda: 400 MHz. Requisiti di alimentazione: DC 12-18V Phantom alimentazione.

Dimensioni (LxHxP): 65x35x75 mm. Peso: 0,150 kg. Antenna direzionale a banda larga. Frequenza: 450-973 MHz. Guadagno: 7 dB. Dimensioni (LxH): 290x260 mm. Peso: 0,180 Kg

Kit composto da:

- 1 unità di distribuzione dell'antenna (1U rack)
- 2 antenne direzionali
- 1 cavo di alimentazione CA
- 4 cavi BNC-BNC
- 4 cavi CC-CC
- 2 cavi TNC

EN - Antenna distributor for 4 wireless transmitters (radiomicrophones). Phantom power supply.

Wide frequency range, covers all the UHF wireless frequency point. Directional broadband antenna. Directional antenna, decrease interference with other devices. Antenna input impedance: 50Ω (cable RG58U50.1 to be ordered separately).

Antenna output impedance: 50Ω (cable RG58U50.1 to be ordered separately). Antenna input socket: TNC. Antenna output socket: TNC. Gain: 3 dB. Band: 200 MHz. Power supply: DC 12-18 V 300 mA. Dimensions (WxHxD): 410x45x160 mm. Weight: 2 kg.

Maximum distance between distributor and antenna: 350mt. Antenna amplifiers. Antenna input impedance: 50Ω (cable RG58U50.1 to be ordered separately). Antenna output impedance: 50Ω (cable RG58U50.1 to be ordered separately).

Antenna input socket: TNC. Antenna output socket: TNC. Gain: 13 dB. Band: 400 MHz. Power requirements: DC 12-18V Phantom power supply. Dimensions (WxHxD): 65x35x75 mm. Weight: 0,150 kg.

Directional broadband antenna. Frequency: 450-973 MHz. Gain: 7 dB. Dimensions (WxH): 290x260 mm. Weight: 0,180 Kg

Kit with:

- 1 antenna distribution unit (1U rack)
- 2 directional antennas
- 1 AC power cable
- 4 cables BNC-BNC
- 4 DC-DC cables
- 2 TNC cables





EAN13

CODE



8052015550621

WSB2603



IT - Kit radiomicrofono doppio con 2 basi da tavolo, ricevitore da tavolo.

CARATTERISTICHE TECNICHE

- Capsula dinamica ipercardiode.
 - Trasmissione in modulazione FM true diversity in banda UHF 640-690MHz.
 - PLL.
 - 100 canali.
 - Sincronizzazione Tx-Rx con IR.
 - Risposta in frequenza: 40 Hz- 15 KHz +/- 3dB.
 - Batterie 2xAA (incluse).
 - Portata 150mt in campo aperto.
- Peso 1,9Kg.

EN - Kit radio microphone with 2 table bases, table receiver.

TECHNICAL FEATURES

- Dynamic hypercardioid capsule.
 - Transmission in true diversity FM modulation UHF band 640-690MHz.
 - PLL.
 - 100 channels.
 - Tx-Rx synchronization with IR.
 - Frequency response: 40 Hz- 15 khz +/- 3db.
 - 2xAA batteries (included).
 - Range 150mt in open field.
- Weight 1,9kg.



8051272186802

WSH1603



IT - Kit radiomicrofono singolo con trasmettitore a mano, ricevitore da tavolo. Capsula dinamica ipercardiode. Trasmissione in modulazione FM true diversity in banda UHF 640-690MHz. PLL. 100 canali. Tx-Rx con IR. 50 Hz- 17 KHz +/- 3dB. Batterie 2xAA (incluse). Portata 100 mt. Peso: 1,8 kg.

EN - Single radio microphone kit with hand transmitter, desk receiver. Hypercardioid dynamic capsule. Transmission in true diversity FM modulation in UHF band 640-690MHz. PLL. 100 channels. Tx-Rx with IR. 50 Hz- 17 KHz +/- 3dB. 2xAA batteries (included). Capacity 100 mt. Weight: 1.8 kg.

8051272186826

WSL1605



IT - Kit radiomicrofono singolo con trasmettitore da tasca e microfoni lavalier + 1 headset per parlato + 1 headset per canto, ricevitore da tavolo. LAVALIER: capsula electrete unidirezionale HEADSET: capsula electrete unidirezionale. Trasmissione in modulazione FM true diversity in banda UHF 640-690MHz. PLL. 100+100 canali. Tx-Rx con IR. 40 Hz- 18 KHz +/- 3dB. Batterie 2xAA (incluse). Portata 100mt. Peso: 1,6 kg.

EN - Single radio microphone kit with pocket transmitter and lavalier microphones + 1 speech headset + 1 singing headset, desk receiver. LAVALIER: unidirectional electrete capsule HEADSET: unidirectional electrete capsule. Transmission in FM true diversity modulation in UHF band 640-690MHz. PLL. 100+100 channels. Tx-Rx with IR. 40 Hz- 18 KHz +/- 3dB. 2xAA batteries (included). Range 100mt. Weight: 1.6 kg.





EAN13

CODE

8051272187298 **WSH2603**



IT - Kit radiomicrofono doppio con trasmettitori a gelato + doppio ricevitore da tavolo integrato in un unico cabinet da 1 unità rack. Capsula dinamica ipercardiode. Trasmissione in modulazione FM true diversity in banda UHF 640-690MHz. PLL. 200 canali. Tx-Rx con IR. 40 Hz- 18 KHz +/- 3dB. Batterie 2xAA (include). Portata 100 mt. Peso: 2,0 kg.

EN - Dual Radio Microphone Kit with Handheld Transmitters + Dual Desktop Receiver Integrated in a Single 1 Rack Unit Cabinet. Hypercardioid dynamic capsule. Transmission in true diversity FM modulation in UHF band 640-690MHz. PLL. 200 channels. Tx-Rx with IR. 40 Hz- 18 KHz +/- 3dB. 2xAA batteries (included). Capacity 100 mt. Weight: 2.0 kg.

8051272187304 **WSHL2603**



IT - Kit radiomicrofono doppio con trasmettitori lavalier + 1 headset per parlato + 1 headset per canto + gelato, doppio ricevitore da tavolo integrato in un unico cabinet da 1 unità rack. LAVALIER: capsula electrete unidirezionale HEADSET: capsula electrete unidirezionale A GELATO: capsula dinamica ipercardiode Trasmissione in modulazione FM true diversity in banda UHF 640-690MHz. PLL. 100+100 canali. Sincronizzazione Tx-Rx con IR. Risposta in frequenza: 40 Hz- 18 KHz +/- 3dB. Batterie 2xAA (include). Portata 100mt in campo aperto. Peso 2,5Kg.

EN - Double radiomicrophone kit with lavalier + 1 speech headset + 1 singing headset + handhead transmitters, double table receiver integrated in a single cabinet with 1 rack unit. LAVALIER: unidirectional electre capsule. HEADSET: unidirectional electre capsule HANDHEAD: dynamic hypercardioid capsule Transmission in true diversity FM modulation in UHF 640-690MHz band. PLL. 100+100 channels. Tx-Rx synchronization with IR. Frequency response: 40 Hz - 18 KHz +/- 3dB. 2xAA batteries (included). Range 100mt in open field. Weight 2,5Kg.

8051272186833 **WSL2605**



IT - Kit radiomicrofono doppio con trasmettitori lavalier (2pz) + headset per parlato (2pz) + headset per canto (2pz), doppio ricevitore da tavolo integrato in un unico cabinet da 1 unità rack. Capsula a condensatore omnidirezionale. Trasmissione in modulazione FM true diversity in banda UHF 640-690MHz. PLL. 200 canali. Tx-Rx con IR. 40 Hz- 18 KHz +/- 3dB. Batterie 2xAA (include). Portata 100mt. Peso: 2,4 kg.

EN - Dual radio microphone kit with lavalier transmitters (2pcs) + 1 speech headset (2pcs) + singing headset (2pcs), dual desktop receiver integrated into a single cabinet of 1 rack unit. Omnidirectional condenser capsule. Transmission in modulation FM true diversity in UHF band 640-690MHz. PLL. 200 channels. Tx-Rx with IR. 40 Hz- 18 KHz +/- 3dB. 2xAA batteries (included). Range 100mt. Weight: 2.4 kg.





EAN13

CODE

Parti di ricambio
Spare parts

8051272186864 | **WTL1605**



IT - Kit di ricambio per trasmettitore da tasca (senza ricevitore) con microfoni lavalier, 1 headset per parlato e 1 headset per canto.
LAVALIER: capsula electrete unidirezionale. **HEADSET:** capsula electrete unidirezionale. Trasmissione in modulazione FM true diversity in banda UHF 640-690MHz. PLL. 100+100 canali. Tx-Rx con IR. 40 Hz- 18 KHz +/- 3dB. Batterie 2xAA (include). Portata 100mt. Peso: 0,3 kg.

EN - Spare kit for pocket transmitter (without receiver) with lavalier microphones, 1 speech headset and 1 singing headset. **LAVALIER:** unidirectional electrete capsule. **HEADSET:** unidirectional electrete capsule. Transmission in true diversity FM modulation in UHF band 640-690MHz. PLL. 100+100 channels. Tx-Rx with IR. 40 Hz- 18 KHz +/- 3dB. 2xAA batteries (included). Range 100mt. Weight: 0.3 kg.

8051272186840 | **WTH1603**



IT - Trasmettitore a mano (senza ricevitore). Capsula dinamica ipercardiode. Trasmissione in modulazione FM true diversity in banda UHF 640-690MHz. PLL. 100 canali. Tx-Rx con IR. 50 Hz- 17 KHz +/- 3dB. Batterie 2xAA (include). Portata 100mt. Peso: 0,3 kg.

EN - Hand transmitter (without receiver). Hypercardioid dynamic capsule. Transmission in true diversity FM modulation in UHF band 640-690MHz. PLL. 100 channels. Tx-Rx with IR. 50 Hz- 17 KHz +/- 3dB. 2xAA batteries (included). Range 100mt. Weight: 0.3 kg.

8051272187311 | **L1605**



IT - Kit di ricambio microfoni lavalier, 1 headset per parlato e 1 headset per canto. Peso: 0,1 kg.

EN - Replacement kit for lavalier microphones and 1 speech headset and 1 singing headset. Weight: 0.1 kg.





BOURNE
TO MELBOURNE
BOURNE IS FROM
THE BOURNE TRILOGY

EN54₁
voice evacuation

Multimedia
supervision

App
remote or local
control

EVO.VISION

Unica App per la TOTALE gestione da remoto di tutte le funzioni dei dispositivi integrati nel sistema di evacuazione, semplificando il controllo dell'intero impianto nell'edificio/i.

Single App for the TOTAL remote management of all the functions of the devices integrated into the system evacuation, simplifying the control of the entire system in the building/s.

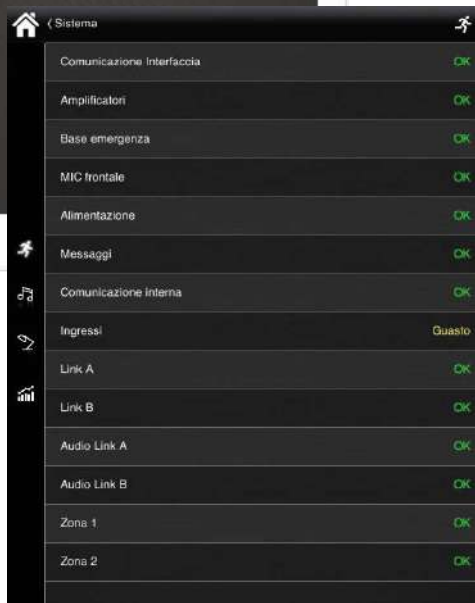
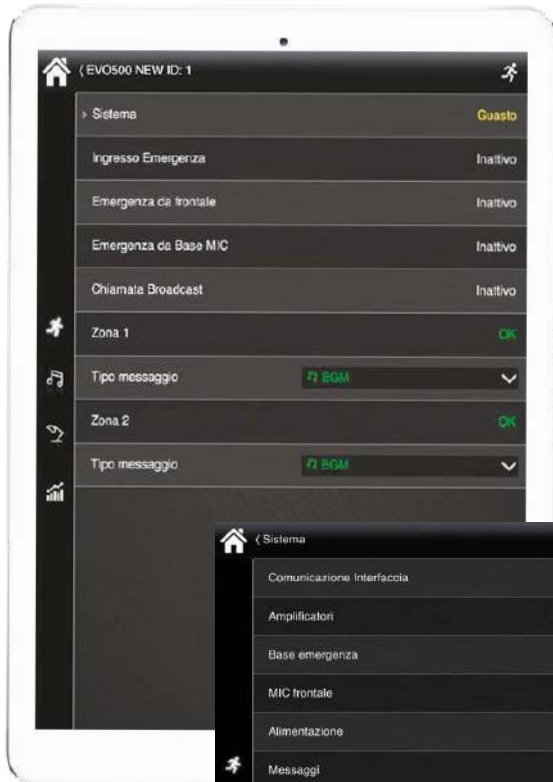

Giove iControl



INTERFACCIA UTENTE
screen di controllo

USER INTERFACE
control screen



Compatibilità Compatibility

Vivaldi EVO500/2
Vivaldi EVO500/4
Vivaldi EVO500/6
Vivaldi EVO500M/2
Vivaldi EVO500M/4

Vivaldi EVO500M/6
Vivaldi EVO1000M/4
Vivaldi EVO1000M/6
Vivaldi EVO+Master

EAN13

CODE

8051272187342

EVO.VISION

Sistema di supervisione per impianti EN54 e dispositivi audio FREESOURCEMK3, tramite APP.

Innovativo dispositivo di supervisione per impianti EN54. Compatibile con EVO500/2, EVO500/4, EVO500/6, EVO500M/2, EVO500M/4, EVO500M/6, EVO1000M/4, EVO1000M/6, EVO+Master

Permette il controllo dei vari dispositivi FREESOURCEMK3 con il vantaggio di poter gestire il tutto comodamente dal proprio Smartphone e Tablet (iOS/Android) o PC (Windows/MacOSX). Ricezione feedback sullo stato impianto attraverso EVO.BRIDGE.

Pre-programmazione inclusa, personalizzazione custom quotazione on-demand. Auto indirizzamento zone.

Esempio di azioni su dispositivi tecnologici FREESOURCEMK3:

- Accensione/Spegnimento
- Regolazione volume
- Regolazione toni
- Cambio frequenza Tuner FM
- Cambio sorgente
- Cambio Traccia/Album lettore USB integrato nel FREESOURCEMK3

- Gestione chiamate microfoniche selettive
- Autoricerca dei comandi di zona FREESOURCEMK3 installati nell'impianto, con creazione automatica di un'interfaccia base
Interfacce grafiche personalizzabili tramite programmazione specifica (My6)

Info tecniche:

- Dimensioni (LxHxP) 54x90x63 mm (3 moduli barra DIN).
- Alimentazione tramite AL2B (da ordinare a parte, da ordinare a parte).
- Certificazioni: RoHS, CE.

SOFTWARE:

- APP di controllo (iOS/Android) disponibili nei rispettivi store (/MAC/PC) disponibile nel sito Vivaldi
- Software di configurazione (WIN/MAC) disponibile nel sito Vivaldi

PROTOCOLLI GESTITI:

- FREESOURCEMK3
- ModBus (EVO.BRIDGE)

CONNESSIONI:

- 2x RS485 (1x Bus FREESOURCEMK3 - 1x Bus EVO.BRIDGE)
- 1x RJ45 (LAN)
- 1x Alimentazione 12-24 VDC

ALIMENTAZIONE:

Alimentatore esterno 24Vcc. Assorbimento Max 1,5A@24VDC.

REQUISITI AMBIENTALI:

Temperatura d'esercizio da +5 a +55° C. Umidità relativa da 5% a 95% (senza condensa).

KIT COMPOSTO DA:

- EVO.VISION (con predisposizione guida DIN)
- Cavo Ethernet Cat5E da 1mt
- Manuale cartaceo

CERTIFICAZIONI DI QUALITÀ: RoHS - CE

Control and supervision system for EVAC systems and audio devices FREESOURCEMK3 via APP.

Innovative supervision device for EVAC EN54 systems. Compatible with EVO500/2, EVO500/4, EVO500/6, EVO500M/2, EVO500M/4, EVO500M/6, EVO1000M/4, EVO1000M/6, EVO+Master

It allows the control of FREESOURCEMK3 easily from Smartphone and Tablet (iOS / Android) or PC (Windows/MacOSX). Receive feedbacks and notifications on system status through EVO.BRIDGE.

Pre-programming included, customization on demand.

Zones Auto-addressing

Example of actions on FREESOURCEMK3:

- Switching on / off
- Volume adjustment
- Tone adjustment (EQ)
- FM Tuner frequency change
- Source change
- Track Change / Album (USB reader) integrated in FREESOURCEMK3

- Management of selective microphone calls (intercom)
- Auto-search for zone modules FREESOURCEMK3 installed in the system, with automatic creation of a basic interface
Customizable graphic interfaces through specific programming (My6).

Technical info:

- Dimensions (WxHxD): 54x90x63 mm (3 DIN bar modules)
- Power supply via AL2B (not included).
- Certifications: RoHS, CE

SOFTWARE:

- Control APP (iOS / Android / MAC / PC)
- Configuration software (WIN / MAC)

PROTOCOLS MANAGED:

- FREESOURCEMK3
- ModBus (EVO.BRIDGE)

CONNECTIONS:

- 2x RS485 (1x Bus FREESOURCEMK3 - 1x Bus EVO.BRIDGE)
- 1x RJ45 (LAN)
- 1x 12-24 VDC power supply

SUPPLY:

External power supply 24Vdc. Absorption Max 1.5A @ 24VDC.

ENVIRONMENTAL REQUIREMENTS:

Operating temperature from +5 to + 55 ° C. Relative humidity from 5% to 95% (without condensation).

KIT INCLUDES:

- EVO.VISION (with DIN rail enclosure)
- Cat5E 1m Ethernet cable
- Paper manual

QUALITY CERTIFICATIONS: RoHS - CE

SCREEN EVO.VISION screen di settaggio
USER INTERFACE control screen



EAN13 CODE

8051272187335 | **EVO.BRIDGE**



Dispositivo di comunicazione tra le centrali EVAC Vivaldi e EVO.VISION.

Protocolli gestiti:

- EVAC (RJ45 link)
- MODBUS RTU (supervisione)

Dimensione: 36x90x63 mm (LxHxP)

2 moduli barra DIN

1x RS485 (ModBus RTU)

1x RJ45 (EVAC LINK)

Alimentazione 12-24 Vdc tramite

AL2B fornito in dotazione

Communication device between the central EVAC Vivaldi and EVO.VISION.

Managed protocols:

- EVAC (RJ45 link)
- MODBUS RTU (supervision)

Dimension: 36x90x63 mm (WxHxD)

2 DIN rail modules

1x RS485 (ModBus RTU)

1x RJ45 (EVAC LINK)

12-24 VDC power supply via AL2B

included

SCHEMA DI PRINCIPIO
PRINCIPLE DIAGRAM

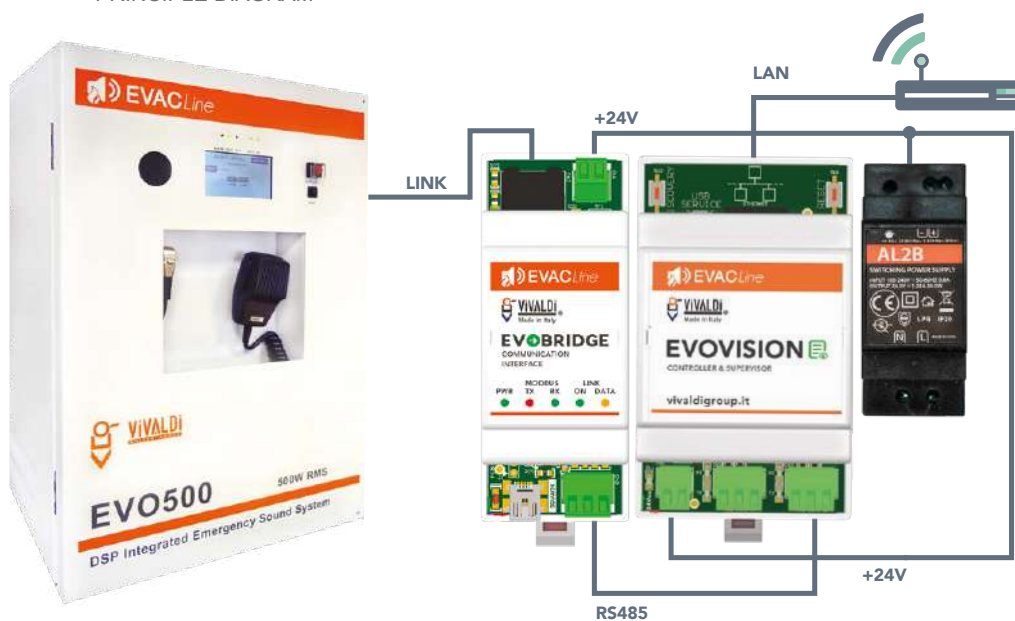

Supervisione e controllo tramite APP per iOS e Android.
Ricezione notifiche push o email sullo stato dell'impianto

Supervision and control via APP for iOS and Android.
Receiving push notifications or emails on status system.



EVO.VISION MONITORA COSTANTEMENTE IL SISTEMA DI EVACUAZIONE VOCALE E NOTIFICA MALFUNZIONAMENTI, GUASTI, ALLERTE O EMERGENZE

EVO.VISION CONSTANTLY MONITORIZES THE VOICE EVACUATION SYSTEM AND NOTIFICATION OF MALFUNCTIONS, BREAKDOWNS, ALERTS OR EMERGENCIES

C'è un malfunzionamento improvviso. EVO.VISION riceve la segnalazione del problema e immediatamente invia la notifica al tecnico
There is a sudden malfunction. EVO.VISION receives the report of the problem and immediately sends the notification to the technician

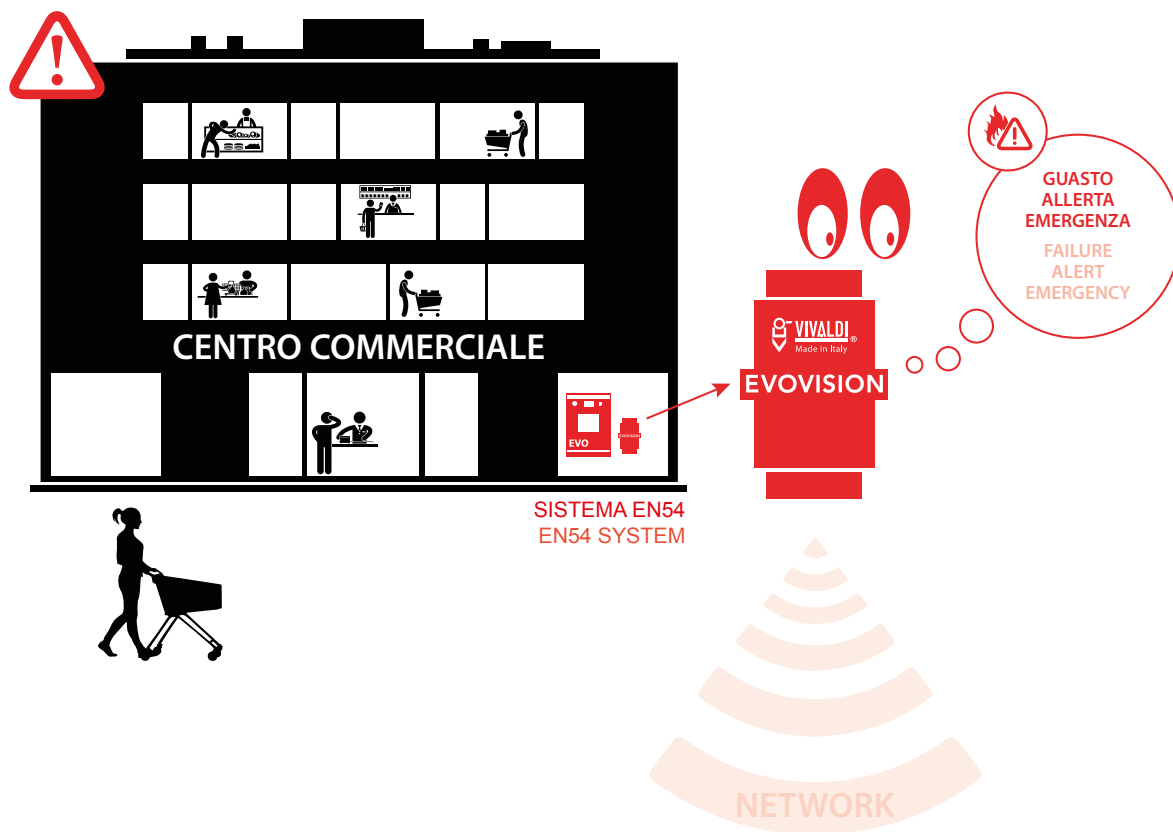

il tecnico riceve la notifica ed interviene
the technician receives the notification and intervenes



Tecnico di sistema aiutato da EVO.VISION a monitorare il sistema di evacuazione vocale nel post-vendita (manutenzione impianto)

System technician assisted by EVO.VISION to monitor the after-sales voice evacuation system (system maintenance)

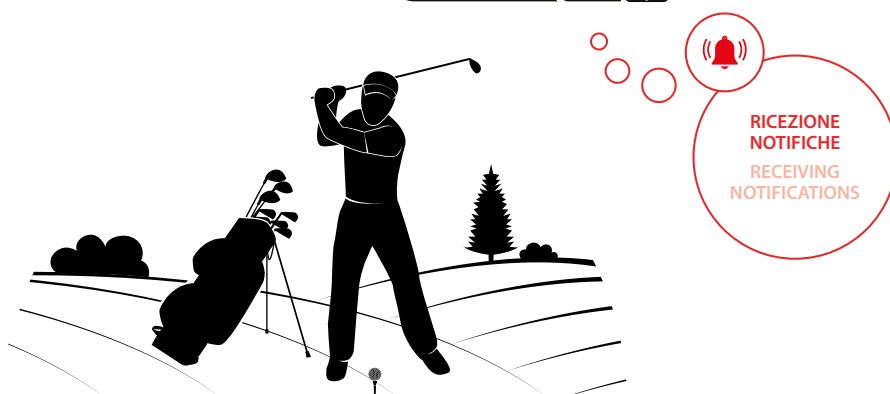

FREESOURCEMK3

OTTIENI IL MASSIMO. Scegli i sistemi di evacuazione vocale EN54 Vivaldi. Abbinare FREESOURCEMK3 alle centrali per avere 6 sorgenti musicali in più in ogni zona e musiche differenti o sincronizzate.

GET THE MOST. Choose Vivaldi's EN54 voice evacuation systems. Combine FREESOURCEMK3 with the control panels to have 6 additional music sources in each area and different music or synchronized.

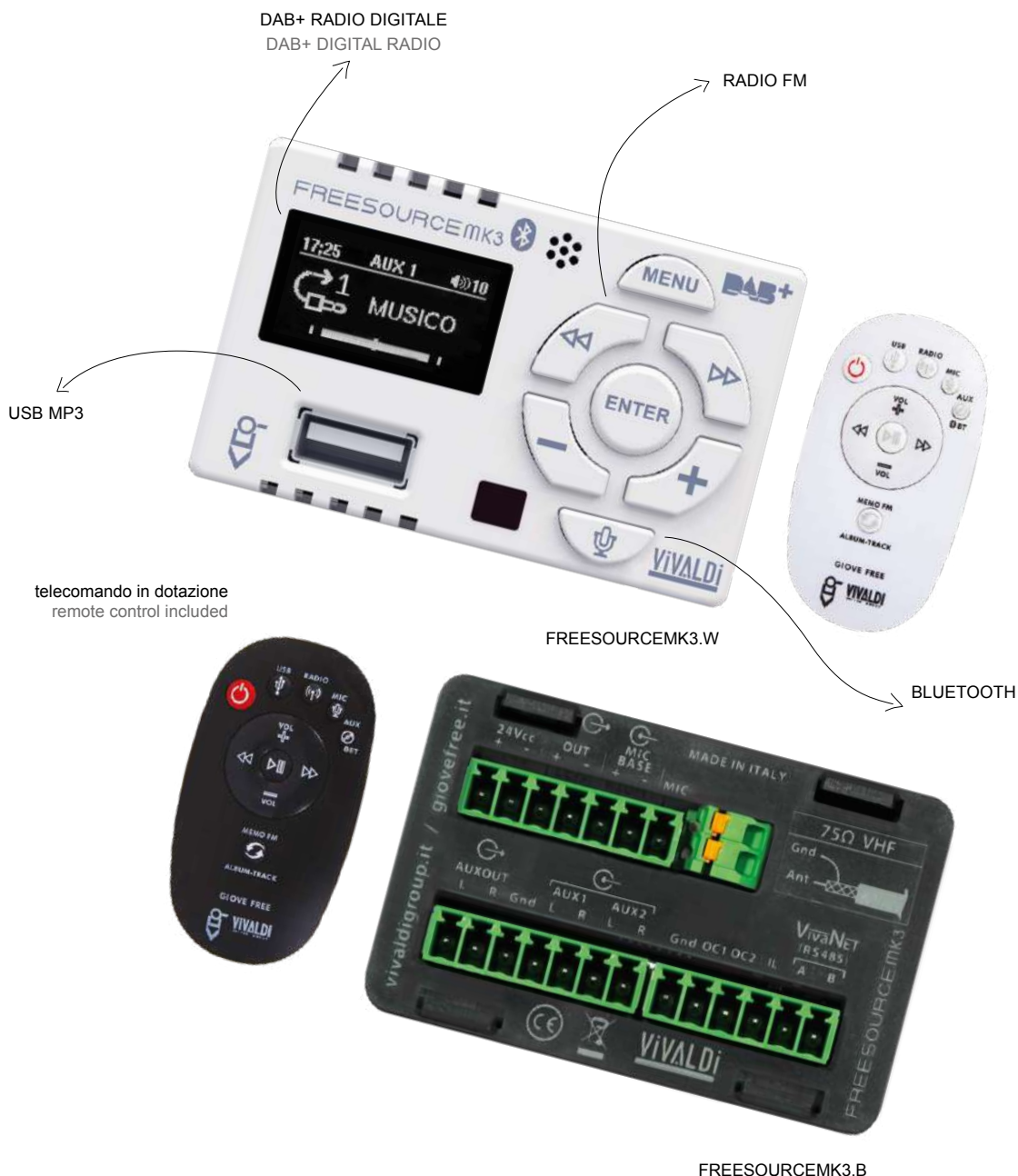

Compatibilità Compatibility

Vivaldi EVO500/2
Vivaldi EVO500/4
Vivaldi EVO500/6
Vivaldi EVO500M/2
Vivaldi EVO500M/4

Vivaldi EVO500M/6
Vivaldi EVO1000M/4
Vivaldi EVO1000M/6
Vivaldi EVO+Master

EAN13	CODE
8051272188219	FREESOURCEMK3.B antracite / anthracite
8051272188226	FREESOURCEMK3.W bianco / white

Multisorgente da incasso su 3 moduli (503, 504...) o rack (con PSK). Controllabile da locale o da remoto tramite EVO.VISION per iOS / Andoroid / Mac / Pc.

Multi-source for flush-mounting on 3 modules (503, 504...) or in a rack (with PSK). Locally or remotely managed via EVO.VISION for iOS / Android / Mac / Pc.

- DAB/DAB+ Radio Digitale
- BLUETOOTH 5.0 (HFP)
- RADIO FM con RDS
- LETTORE USB
- Equalizzatore grafico a 7 Bande
- Display OLED
- Ricevitore IR
- 2 ingressi ausiliari per sorgenti esterne (es. KEYSOL WIFI)
- 1 ingresso Bilanciato per base microfonica
- 1 uscita PreOut

Compatibilità con serie civili tramite ADATTATORI (da ordinare a parte vedi pag 54-55).

Compatibilità rack con P4RC (da ordinare a parte vedi pag 94).

Necessita di alimentatore AL2B (da ordinare a parte).

- DAB / DAB + Digital Radio
- BLUETOOTH 5.0 (HFP)
- FM RADIO with RDS
- USB READER
- 7 Band Graphic Equalizer
- OLED display
- IR receiver
- 2 auxiliary inputs for external sources (ex. KEYSOL WIFI)
- 1 balanced input for microphone base
- 1 PreOut output

Compatibility with civil series via ADAPTERS (not included see page 54-55).

Rack compatibility with P4RC (not included see page 94).

Requires AL2B power supply (not included).

SCHEMA TECNICO DI PRINCIPIO. SISTEMA DI EVACUAZIONE CON MATRICE COMPATTA DA 4 ZONE. MESSAGGI E MUSICHE DIVERSI IN OGNI ZONA. APP DI SUPERVISIONE E CONTROLLO DA LOCALE O DA REMOTO.

TECHNICAL PRINCIPLE DIAGRAM. EVACUATION SYSTEM WITH COMPACT 4 ZONE MATRIX. DIFFERENT MESSAGES AND MUSIC IN EVERY AREA. LOCAL OR REMOTE SUPERVISION AND CONTROL APP.

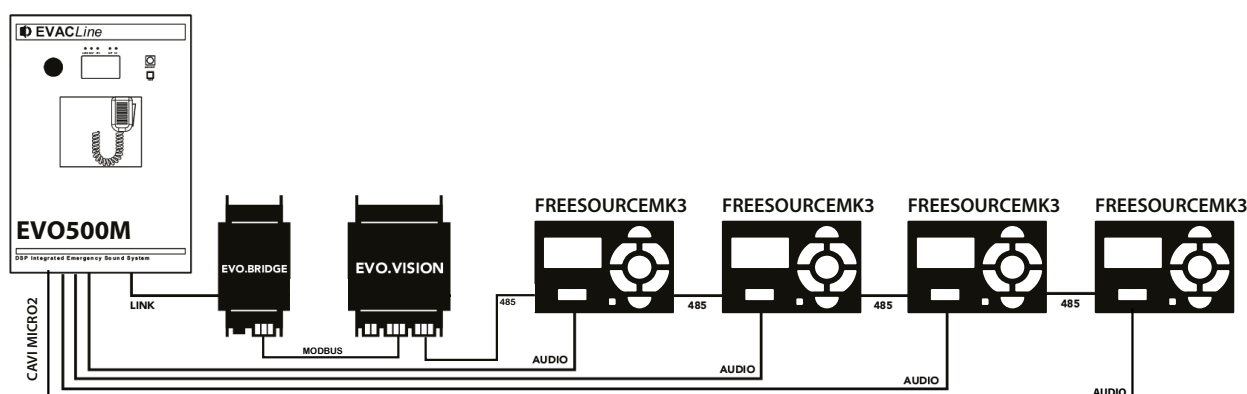

Supervisione e controllo tramite APP per iOS e Android.
Ricezione notifiche push o email sullo stato dell'impianto

Supervision and control via APP for iOS and Android.
Receiving push notifications or emails on status system.



	EAN13	CODE
	8052015550676	EVO100/1 0068-CPR-178/2023
	8052015550683	EVO100/2 0068-CPR-178/2023
	8052015550652	EVO250/1 0068-CPR-178/2023
	8052015550669	EVO250/2 0068-CPR-178/2023
	8052015550690	BATTERIA12AH
	8052015550942	EVO.EXPIBOARD

- installabile a parete
- necessita di 2 BATTERIA12AH
- disponibile scheda di estensione per poter effettuare una chiamata generale su tutti gli apparecchi collegati o per avere un ingresso musicale aggiuntivo (EVO.EXPIBOARD)

- wall mountable
- requires 2 batteries BATTERIA12AH
- extension card available to be able to make a general call on all connected devices or to have an additional music input (EVO.EXPIBOARD)

BATTERIA12AH

per centrali compatte EVO100 e EVO250 certificata EN60896-21/22 da 12Ah.
for compact EVO100 and EVO250 certified EN60896-21/22 of 12Ah.



EVO.EXPIBOARD

Scheda di espansione per il collegamento di più centrali EVO100 e EVO250 o per avere un ingresso musicale aggiuntivo.
Expansion board for connecting multiple control panels EVO100 and EVO250 or for additional music input.

**CENTRALI COMPATTE ALL-IN-ONE. DIFFUSIONE SONORA E MESSAGGISTICA.
MESSAGGI GENERALI O DIVERSIFICATI NELLE ZONE**

**COMPACT ALL-IN-ONE CENTRAL. SOUND DIFFUSION AND MESSAGING.
GENERAL OR DIVERSIFIED MESSAGES IN THE ZONES**

	EVO100/1	EVO100/2	EVO250/1	EVO250/2
potenza nominale / rated power	100W complessivi, distribuiti sulle zone con il limite massimo di 100W per ciascuna zona overall, distributable among the zones with 100W max limit per zone		250W complessivi, distribuiti sulle zone con il limite massimo di 250W per ciascuna zona overall, distributable among the zones with 250W max limit per zone	
nr amplificatori/zone / amplifiers/zones nr	1	2	1	2
funzione / function	chiamate di emergenza, messaggi di servizio, diffusione sonora HiFi emergency calls, service messages, HiFi public address			
supervisionabile da APP/ managed by APP	si, con notifiche stato impianto e guasti yes, with system status and failure notifications		si, con notifiche stato impianto e guasti yes, with system status and failure notifications	
messaggi / messages	allerta e emergenza, personalizzabili / alert and emergency, customizable			
display	4,3" TFT a colori, touch screen / color 4,3" TFT, touch screen			
memoria eventi / event log	si / yes	si / yes	si / yes	si / yes
altoparlante monitor / monitor speaker	integrato / integrated	integrato / integrated	integrato / integrated	integrato / integrated
microfono d'emergenza / emergency microphone	palmare VVF incluso FD handheld included	palmare VVF incluso FD handheld included	palmare VVF incluso FD handheld included	palmare VVF incluso FD handheld included
basi emergency / emergency desktop bases	collegabili fino a 2 basi ogni centrale / linkable, up to 2 base for central			
RJ45 emergency desk	1	1	1	1
IN AUX (vox/priority contact), bil	1	1	1	1
Out zone @100V (A/B)	1*	2*	1*	2*
	*un'uscita di zona può essere configurata come riserva per le rimanenti * 1 zone OUT can be configured as secondary amplifier			
EXT link card (optional)	scheda estensione opzionale: permette la diffusione di 1 messaggio broadcast alle altre centrali optional extension card: allows the diffusion of 1 broadcast message to the other control panels			
EMG check input	4 IN con diagnosi, 2 relè per segnalazione stato d'emergenza e guasto 4 IN with diagnostic, 2 off relay outputs, configurable for emergency status and failure report			
monitoraggio linee / line monitoring	rilevazione automatica di interruzione linea, corto circuito o variazione impedenza automatic detection of line break, short circuit or impedance variation			
alimentazione / power supply	230Vca 50/60 Hz +10/-15%	230Vca 50/60 Hz +10/-15%	230Vca 50/60 Hz +10/-15%	230Vca 50/60 Hz +10/-15%
alimentazione secondaria / secondary power supply	24Vcc, 4,2A a pieno carico 24Vcc, 4,2A at full load	24Vcc, 4,2A a pieno carico 24Vcc, 4,2A at full load	24Vcc, 9,8A a pieno carico 24Vcc, 9,8A at full load	24Vcc, 9,8A a pieno carico 24Vcc, 9,8A at full load
batterie compatibili / compatible batteries	2x12AH(non comprese) monitoraggio interno controllo resistenza e tensione 2x12AH (not included) internal impedance and voltage control			
autonomia interna / battery life	24h stand-by + 1/2h full power	24h stand-by + 1/2h full power	24h stand-by + 1/2h full power	24h stand-by + 1/2h full power
temperatura d'esercizio / operating temperature	+5°C +40°C	+5°C +40°C	+5°C +40°C	+5°C +40°C
installazione / installation	a parete / wall-mounted			
dimensioni LxHxD / size WxHxD	360x495x193 mm	360x495x193 mm	360x495x193 mm	360x495x193 mm
peso (senza batterie) / weight (without batteries)	11,5 kg	11,5 kg	11,5 kg	11,5 kg
software	multilingue / multilingual			

EAN13	CODE
8051272188257	EVO500M/2 0068-CPR-135/2019
8051272188264	EVO500M/4 0068-CPR-135/2019
8051272188271	EVO500M/6 0068-CPR-135/2019
8051272188301	EVO1000M/4 0068-CPR-134/2019
8051272188318	EVO1000M/6 0068-CPR-134/2019
8051272183573	BATTERIA26AH
8051272183580	BATTERIA40AH
8051272188288	EVOM.2INPUT
8051272188295	EVOM.6INPUT
8051272189216	EVO.RACKADP



REMOTE CONTROL



EVO.VISION FEEDBACK



NOTIFICATIONS



MUSIC



MESSAGES

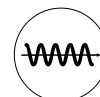

PURE SOUND

- installabile a parete
- installabile a rack tramite EVO.RACKADP
- EVO500M necessita di 2 BATTERIA26AH
- EVO1000M necessita di 2 BATTERIA40AH
- disponibili schede per espandere il numero di ingressi musicali:
EVO.2INPUT, 2 ingressi sorgente
EVO.6INPUT, 6 ingressi sorgente

- wall mountable
- rack mountable via EVO.RACKADP
- requires 2 batterie: BATTERIA26AH
- requires 2 batteries BATTERIA40AH
- tabs available to expand the number of music inputs:
EVOM.2INPUT, 2 source inputs
EVOM.6INPUT, 6 source inputs



EVO.RACKADP

BATTERIA26AH

per centrali e matrici compatte EVO500 certificata EN60896-21/22 da 26Ah.
for compact matrices EVO500 certified EN60896-21 / 22 of 26Ah.



BATTERIA40AH

per centrali e matrici compatte EVO500 certificata EN60896-21/22 da 40Ah.
for compact matrices EVO500 certified EN60896-21 / 22 of 40Ah.



EVOM.2INPUT EVOM.6INPUT

schede per aggiungere ingressi indipendenti alle matrici.
INPUT cards to add independent in to matrix.



EVOM.2INPUT



EVOM.6INPUT

**MATRICI COMPATTE ALL-IN-ONE. DIFFUSIONE SONORA E MESSAGGISTICA. MUSICHE E MESSAGGI GENERALI
O DIVERSIFICATI NELLE ZONE**
**COMPACT ALL-IN-ONE MATRICES. SOUND DIFFUSION AND MESSAGING. GENERAL OR DIVERSIFIED MUSIC
AND MESSAGES IN THE ZONES**

	EVO500M/2	EVO500M/4	EVO500M/6	EVO1000M/4	EVO1000M/6
potenza nominale / rated power	500W complessivi, distribuiti sulle zone con il limite massimo di 250W per ciascuna zona overall, distributable among the zones with an 250W max limit per zone			1000W complessivi, distribuiti sulle zone con il limite massimo di 250W per ciascuna zona overall, distributable among the zones with an 250W max limit per zone	
nr amplificatori/zone / amplifiers/zones nr	2	4	6	4	6
funzione / function	chiamate di emergenza, messaggi di servizio, diffusione sonora HiFi emergency calls, service messages, HiFi public address				
supervisionabile da APP/ managed by APP	si, con notifiche stato impianto e guasti yes, with system status and failure notifications				
messaggi / messages	fino a 8: allerta, emergenza, servizio, personalizzabili (evacuazione ed allerta preinstallati) up to 8: alert, emergency, service, customizable (evac ed alert pre-installed)				
timer	16	16	16	16	16
display	4,3" TFT a colori, touch screen color 4,3" TFT, touch screen	4,3" TFT a colori, touch screen color 4,3" TFT, touch screen	4,3" TFT a colori, touch screen color 4,3" TFT, touch screen	4,3" TFT a colori, touch screen color 4,3" TFT, touch screen	4,3" TFT a colori, touch screen color 4,3" TFT, touch screen
memoria eventi / event log	si / yes	si / yes	si / yes	si / yes	si / yes
altoparlante monitor / monitor speaker	integrato integrated	integrato integrated	integrato integrated	integrato integrated	integrato integrated
microfono d'emergenza / emergency microphone	palmare per VVF in dotazione FD handheld included	palmare per VVF in dotazione FD handheld included	palmare per VVF in dotazione FD handheld included	palmare per VVF in dotazione FD handheld included	palmare per VVF in dotazione FD handheld included
tipologia microfono / microphone type	bilanciato, XLR-M balanced, XLR-M	bilanciato, XLR-M balanced, XLR-M	bilanciato, XLR-M balanced, XLR-M	bilanciato, XLR-M balanced, XLR-M	bilanciato, XLR-M balanced, XLR-M
basi emergency / emergency desktop bases	collegabili fino a 4 per ogni matrice linkable, up to 4 for each matrix	collegabili fino a 4 per ogni matrice linkable, up to 4 for each matrix	collegabili fino a 4 per ogni matrice linkable, up to 4 for each matrix	collegabili fino a 4 per ogni matrice linkable, up to 4 for each matrix	collegabili fino a 4 per ogni matrice linkable, up to 4 for each matrix
IN RJ45 emergency desk	1	1	1	1	1
IN AUX (vox/priority contact), bil	1	1	1	1	1
IN music, bil	1	1	1	1	1
equalizzatore/ equalizer	integrato, a 3 bande, indipendente per ogni zona e per ogni ingresso musicale integrated, 3-band, independent for each zone and for each music input				
Out zone @100V (A/B)	2*	4*	6*	4*	6*
	*un'uscita di zona può essere configurata come riserva per le rimanenti * 1 zone OUT can be configured as secondary amplifier				
RJ45 LINK	4 per link ad altra EVO500/2/4/6 (max 6 centrali in daisy chain) 4 per link to other EVO500/2/4/6 (max 6 units in daisy chain)				
EMG check	7 IN con diagnosi, 3 relè programmabili d'uscita per segnalazione stato d'emergenza e guasto 7 IN with diagnostic, 3 off relay outputs, configurable for emergency status and failure report				
monitoraggio linee / line monitoring	rilevazione automatica di interruzione linea, corto circuito o variazione impedenza automatic detection of line break, short circuit or impedance variation				
alimentazione / power supply	230Vca 50/60 Hz	230Vca 50/60 Hz	230Vca 50/60 Hz	90 - 264Vca 47/63 Hz	90 - 264Vca 47/63 Hz
alimentazione secondaria / secondary power supply	20A a pieno carico 20A at full load	20A a pieno carico 20A at full load	20A a pieno carico 20A at full load	40A a pieno carico 40A at full load	40A a pieno carico 40A at full load
batterie compatibili / compatible batteries	2x18AH/26AH/33AH/40AH (non comprese) monitoraggio interno controllo resistenza e tensione 2x18AH/26AH/33AH/40AH (not included) internal impedance and voltage control			2x40AH (non comprese) monitoraggio interno controllo resistenza e tensione 2x40AH (not included) internal impedance and voltage control	
autonomia interna / battery life	36h stand-by + 0,5h full power	36h stand-by + 0,5h full power	36h stand-by + 0,5h full power	36h stand-by + 0,5h full power	36h stand-by + 0,5h full power
temperatura d'esercizio / operating temperature	+5°C +40°C	+5°C +40°C	+5°C +40°C	+5°C +40°C	+5°C +40°C
installazione / installation	a parete, da appoggio, a rack tramite EVO500.ADP wall-mounted, bookshelf, on rack through EVO500.ADP				
dimensioni LxHxP / size WxHxD	430x620x240 mm	430x620x240 mm	430x620x240 mm	430x620x240 mm	430x620x240 mm
peso (senza batterie) / weight (without batteries)	19,3 kg	19,9 kg	19,9 kg	23,3 kg	24,3 kg
software	multilingue multilingual	multilingue multilingual	multilingue multilingual	multilingue multilingual	multilingue multilingual

EAN13	CODE
8051272180732	EVO500L 0068-CPR-046/2016
8051272180701	EVO500/2 0068-CPR-046/2016
8051272180718	EVO500/4 0068-CPR-046/2016
8051272180725	EVO500/6 0068-CPR-046/2016
8051272183573	BATTERIA26AH
 8051272189216	EVO.RACKADP

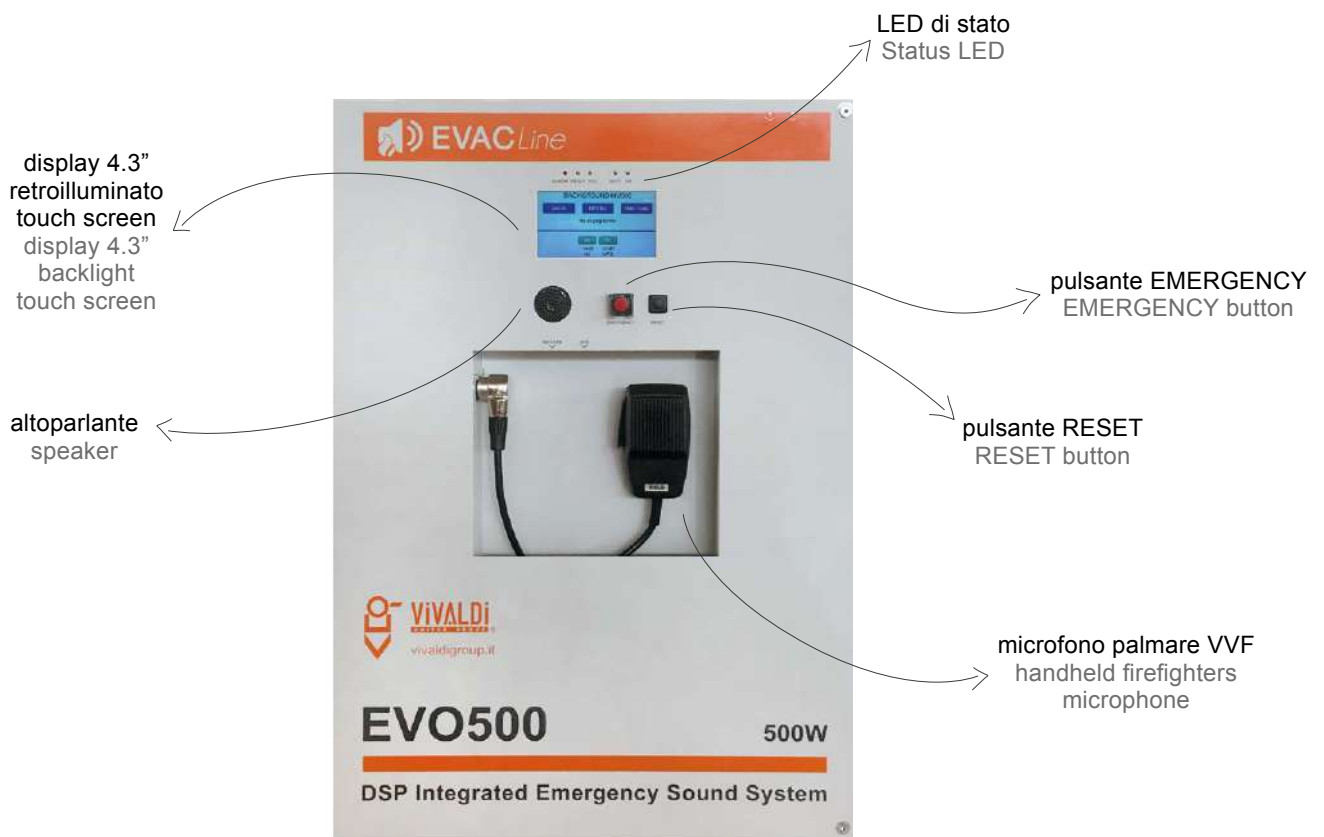

- installabile a parete
- installabile a rack tramite EVO.RACKADP
- necessita di 2 BATTERIA26AH

- wall mountable
- rack mountable via EVO.RACKADP
- requires 2 batteries: BATTERIA26AH



EVO.RACKADP

BATTERIA26AH

per centrali e matrici compatte EVO500 certificata EN60896-21/22 da 26Ah.
for compact matrices EVO500 certified EN60896-21 / 22 of 26Ah.



CENTRALI COMPATTE ALL-IN-ONE. DIFFUSIONE SONORA E MESSAGGISTICA. MESSAGGI GENERALI O DIVERSIFICATI NELLE ZONE

COMPACT ALL-IN-ONE CONTROL UNIT. SOUND DIFFUSION AND MESSAGING. GENERAL OR DIVERSIFIED MESSAGES IN THE ZONES

	EVO500L	EVO500/2	EVO500/4	EVO500/6
potenza nominale / rated power	500W complessivi, distribuiti sulle zone con il limite massimo di 250W per ciascuna zona overall, distributable among the zones with 250W max limit per zone			
nr amplificatori/zone / amplifiers/zones nr	2	2	4	6
funzione / function	chiamate di emergenza, messaggi di servizio, diffusione sonora HiFi emergency calls, service messages, HiFi public address			
supervisionabile da APP/ managed by APP	no	si, con notifiche stato impianto e guasti yes, with system status and failure notifications	si, con notifiche stato impianto e guasti yes, with system status and failure notifications	si, con notifiche stato impianto e guasti yes, with system status and failure notifications
messaggi / messages	allerta e emergenza, personalizzabili / alert and emergency, customizable			
display	4,3" TFT a colori, touch screen / color 4,3" TFT, touch screen			
memoria eventi / event log	si / yes	si / yes	si / yes	si / yes
altoparlante monitor / monitor speaker	integrato / integrated	integrato / integrated	integrato / integrated	integrato / integrated
microfono d'emergenza / emergency microphone	palmare VVF incluso FD handheld included	palmare VVF incluso FD handheld included	palmare VVF incluso FD handheld included	palmare VVF incluso FD handheld included
tipologia microfono / microphone type	bilanciato, XLR-M balanced, XLR-M	bilanciato, XLR-M balanced, XLR-M	bilanciato, XLR-M balanced, XLR-M	bilanciato, XLR-M balanced, XLR-M
basi emergency / emergency desktop bases	collegabili fino a 4 per ogni matrice / linkable, up to 4 for each matrix			
RJ45 emergency desk	1	1	1	1
IN AUX (vox/priority contact), bil	---	1	1	1
IN music, bil	1	1	1	1
Out zone @100V (A/B)	2*	2*	4*	6*
	*un'uscita di zona può essere configurata come riserva per le rimanenti * 1 zone OUT can be configured as secondary amplifier			
RJ45 LINK	---	2 per link ad altra EVO500/2/4/6 (max 6 centrali in daisy chain) 2 per link to other EVO500/2/4/6 (max 6 units in daisy chain)		
EMG check	7 IN con diagnosi, 1 relè per segnalazione stato d'emergenza e guasto 7 IN with diagnostic, 1 off relay output, configurable for emergency status and failure report	7 IN con diagnosi, 3 relè per segnalazione stato d'emergenza e guasto 7 IN with diagnostic, 3 off relay outputs, configurable for emergency status and failure report		
monitoraggio linee / line monitoring	rilevazione automatica di interruzione linea, corto circuito o variazione impedenza automatic detection of line break, short circuit or impedance variation			
alimentazione / power supply	230Vca 50/60 Hz +10/-15%	230Vca 50/60 Hz +10/-15%	230Vca 50/60 Hz +10/-15%	230Vca 50/60 Hz +10/-15%
alimentazione secondaria / secondary power supply	24Vcc, 20A a pieno carico 24Vcc, 20A at full load	24Vcc, 20A a pieno carico 24Vcc, 20A at full load	24Vcc, 20A a pieno carico 24Vcc, 20A at full load	24Vcc, 20A a pieno carico 24Vcc, 20A at full load
batterie compatibili / compatible batteries	2x18AH/26AH/33AH/40AH (non comprese) monitoraggio interno controllo resistenza e tensione 2x18AH/26AH/33AH/40AH (not included) internal impedance and voltage control			
autonomia interna / battery life	36h stand-by + 0,5h full power	36h stand-by + 0,5h full power	36h stand-by + 0,5h full power	36h stand-by + 0,5h full power
temperatura d'esercizio / operating temperature	+5°C +40°C	+5°C +40°C	+5°C +40°C	+5°C +40°C
installazione / installation	a parete, da appoggio, a rack tramite EVO500.ADP wall-mounted, bookshelf, on rack through EVO500.ADP			
dimensioni LxHxP / size WxHxD	430x620x240 mm	430x620x240 mm	430x620x240 mm	430x620x240 mm
peso (senza batterie) / weight (without batteries)	19,3 kg	19,4 kg	19,5 kg	19,6 kg
software	multilingue / multilingual			

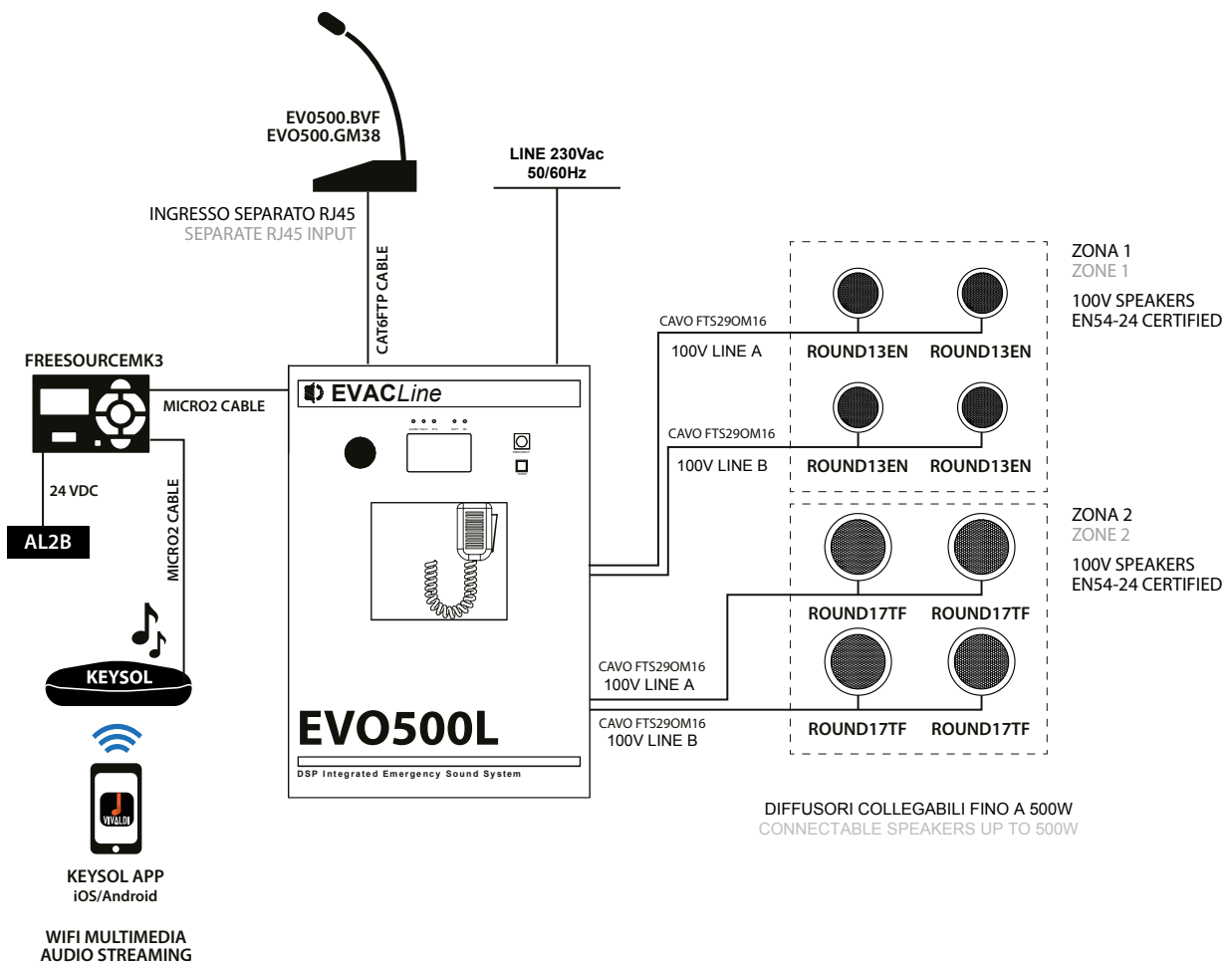
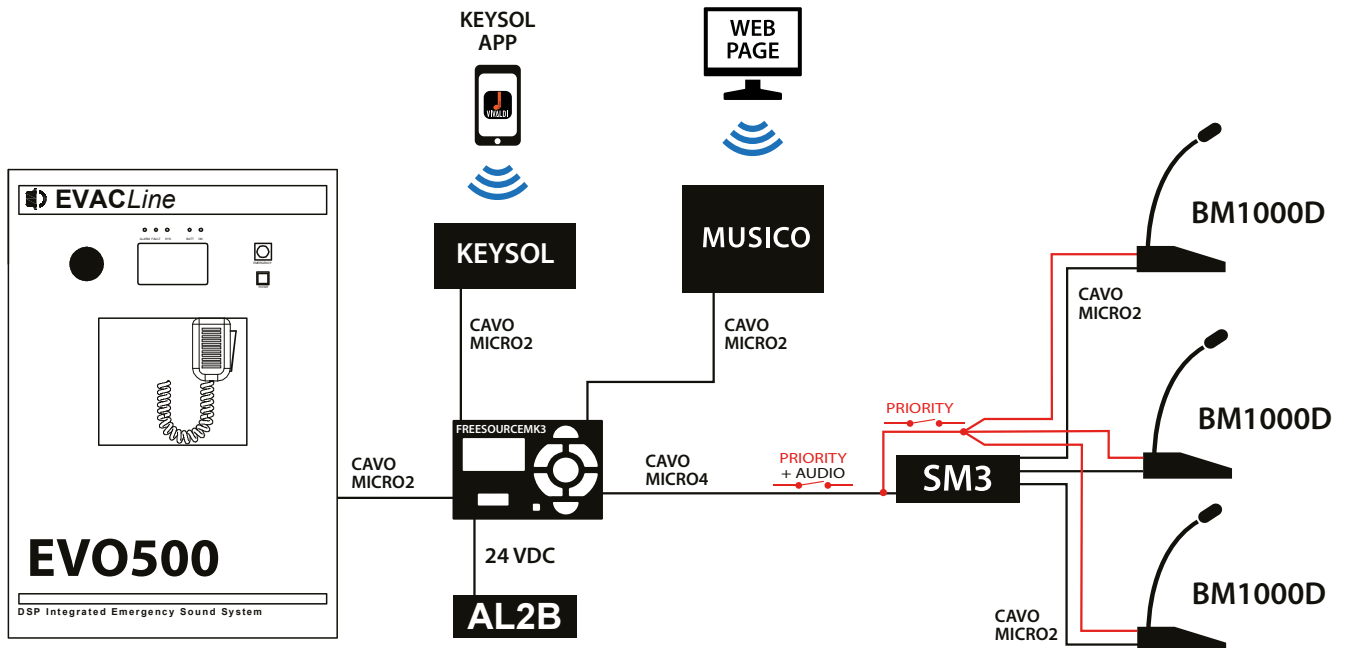

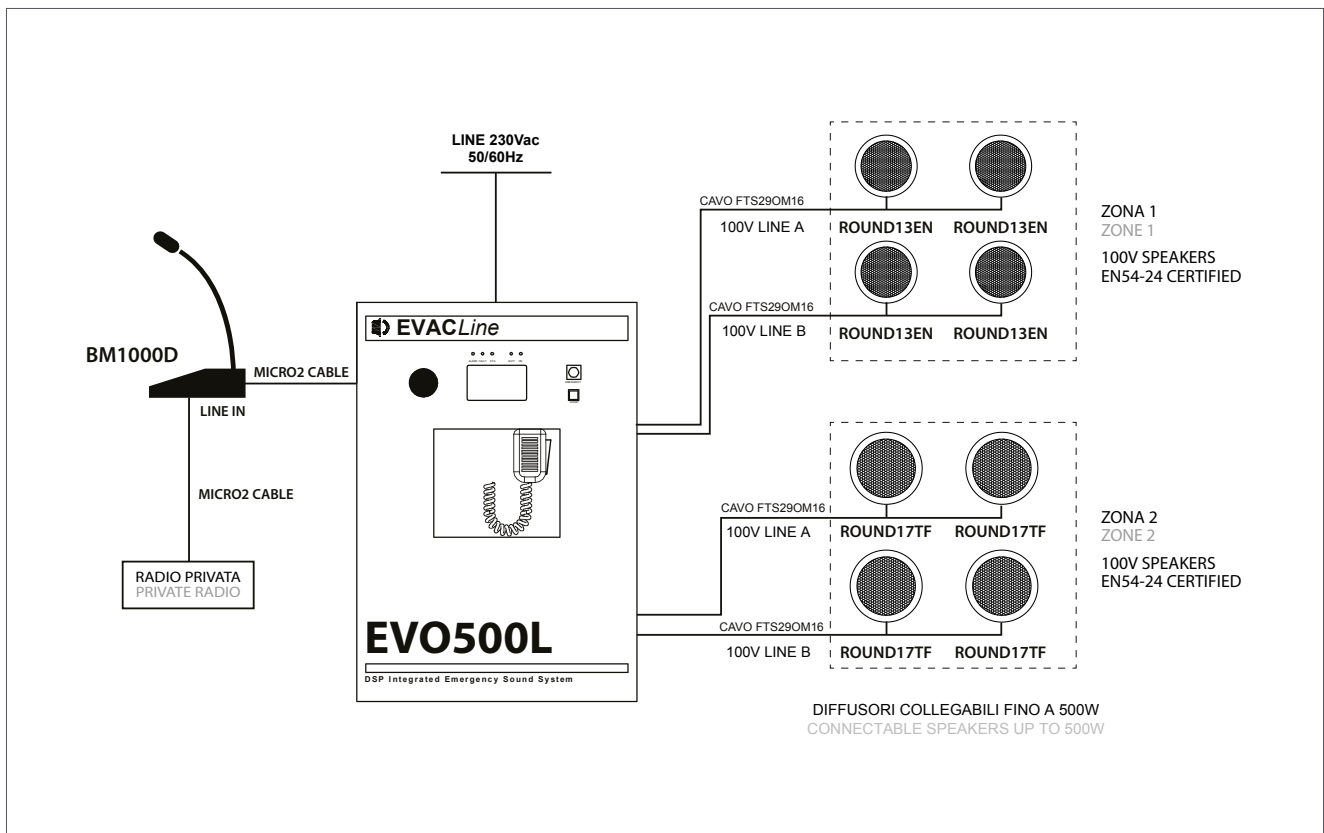
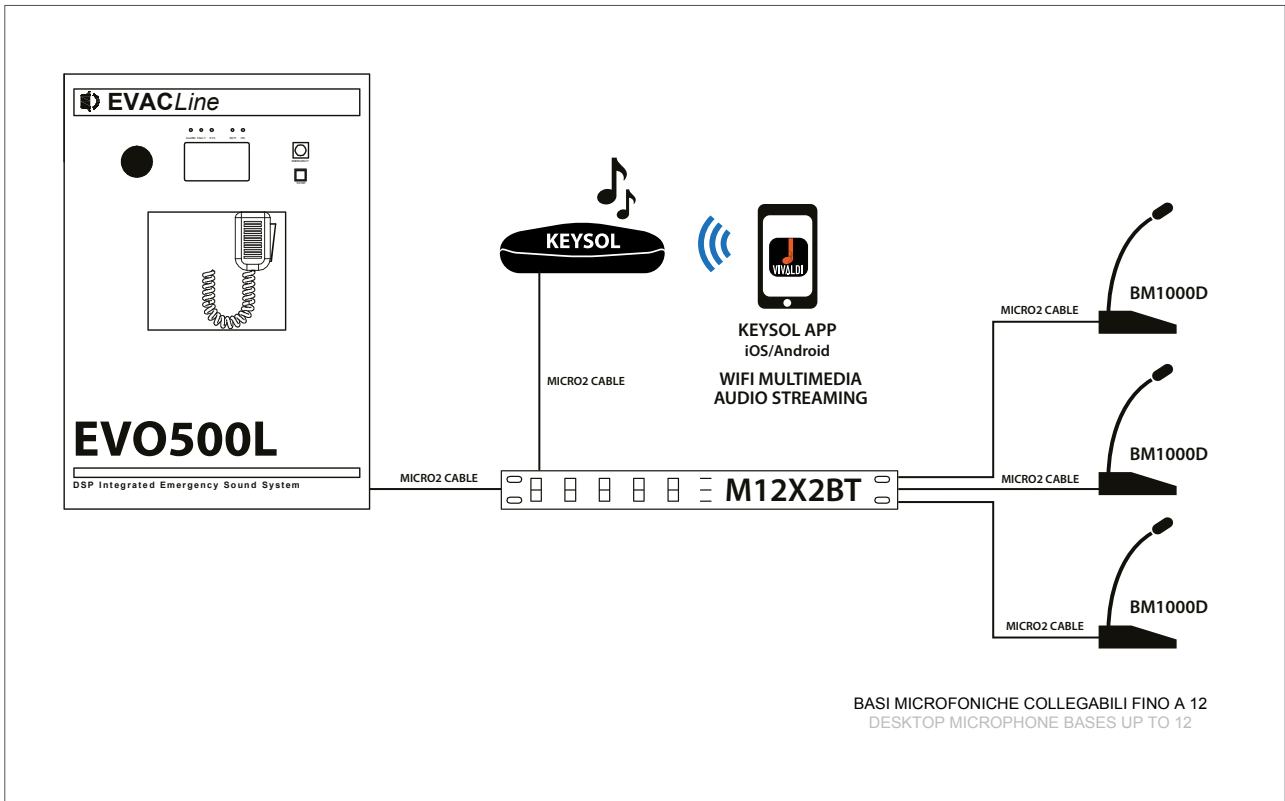

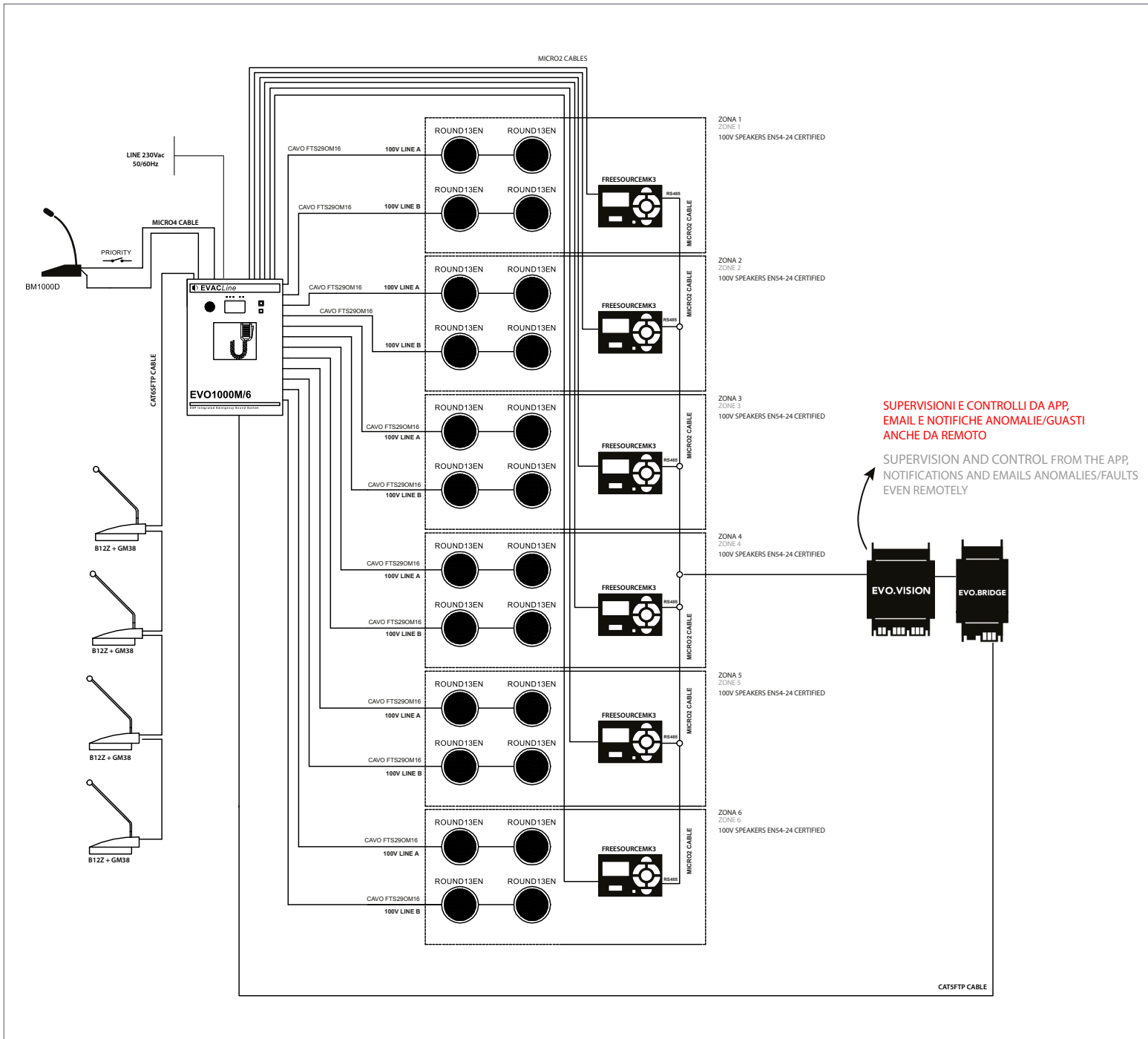

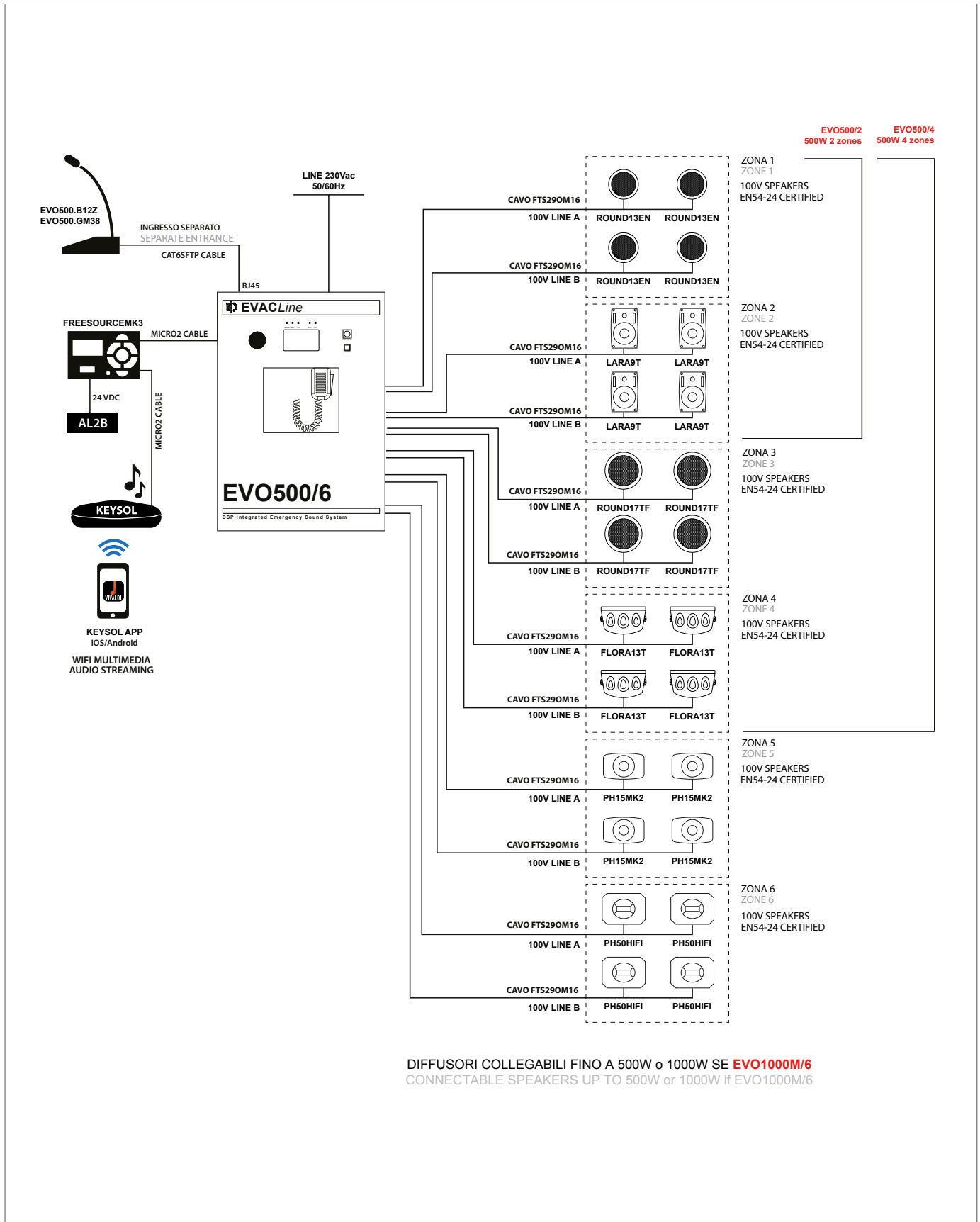

EAN13

CODE

8051272188325 **BM1000D**



IT - Base microfonica da tavolo (predisposta per appoggio o incasso) con DIN-DON. Ideale per negozi, supermercati, fabbriche, scuole, centri sportivi...
LED Power.
LED Busy.
LED Mic.
Pulsante push to talk.
Microfono a stelo da 46cm, electrete, con collarino luminoso e filtro antipop.
Contatto in uscita per attivazione priorità (evacuazione, pubblicitari...)
Segnale in uscita regolabile 10÷200mV.
Ingresso di linea per sorgente ausiliaria.
Ingresso micro USB per inserimento di CHIME personalizzati (DIN-DON, campanella, ...)
Selettore per attivazione segnale Chime prima della chiamata.
Selettore livello di uscita LINEA (0V a 800mV) o MIC (da 0 a 10mV).
Alimentazione 12V.
Alimentatore DC e cavo intestato XLR da 5mt, a corredo.
Dimensioni base (LxHxP): 170x130x50 mm.
Microfono (L) 460 mm.
Peso 1,357 Kg.

EN - Desktop microphone base (prepared for shelf or recessed) with DIN-DON.
Ideal for shops, supermarkets, factories, schools, sports centers...
LED Power.
Led Busy.
LED Mic.
Push to talk button.
46cm stem microphone, electrete, with luminous collar and pop filter.
Outgoing contact for priority activation (evacuation, advertising...)
Adjustable output signal 10÷200mV.
Line input for auxiliary source.
Micro USB input for insertion of custom CHIME (DIN-DON, bell, ...)
Selector for Chime signal activation before the call.
LINE output level selector (0V to 800mV) or MIC (0 to 10mV).
Power supply 12V.
DC power supply and 5mt XLR cable, included.
Base dimensions (WxHxD): 170x130x50 mm.
Microphone (L) 460 mm.
Weight 1,357 Kg.

8051272180770 **EVO500.PTT** 0068-CPR-046/2016



IT - Microfono palmare per vigili del fuoco stile PTT da abbinare alle basi microfoniche a lato. **Certificato EN60849 EN54-16, EN54-4.**
Peso: 0,3 Kg.

EN - PTT-style handheld firefighter microphone to match the microphone bases to the side. **Certificate EN60849 EN54-16, EN54-4.** Weight: 0,3 Kg.

8051272180763 **EVO500.GM38** 0068-CPR-046/2016



IT - Asta gooseneck per basi microfoniche. Estensione 38 cm. Connettore XLR. **Certificato EN54-16, EN54-4.** Colore nero antracite.
Peso: 0,3 Kg.

EN - Gooseneck rod for microphone bases. Extension 38 cm. XLR connector. **Certified EN54-16, EN54-4.** Anthracite black colour.
Weight: 0,3 Kg.

EAN13

CODE

8051272180756 **EVO500.BVF** 0068-CPR-046/2016

IT - Base microfonica di emergenza, per invio messaggi dal vivo o pre-registrati (allerta/evacuazione). Certificazioni CE. **Certificata EN54-16.**

Da utilizzare in abbinamento all'asta microfonica gooseneck GM38 o al microfono palmare EVO500.PTT.

- Presa per microfono
 - LED indicatori di stato
 - Pulsante d'emergenza
 - Pulsante per interruzione messaggi, buzzer guasti
 - Pulsante invio messaggio d'allerta pre-registrato
 - Pulsante invio messaggio d'evacuazione pre-registrato
 - Pulsante di chiamata
 - Connettori RJ45 ingresso/uscita
 - Assorbimento max @24Vcc 60 mA
 - Livello d'uscita tipico 300 mV
 - Distorsione < 1%
 - Risposta in frequenza 130 ÷ 19.000Hz
 - Filtro LOW CUT -3 dB / 380 Hz
- Dimensioni 140x80x200 mm (LxHxP)
Peso 0,77 kg.

EN - Emergency desktop base, for sending live emergency messages or pre-registered (alert/evacuation). CE certifications. **Certificate EN54-16.**

To be used in combination with the GOOSENECK GM38 microphone stand or the EVO500 handheld microphone. PTT.

- Microphone jack
 - LED status indicators
 - Emergency push button
 - Push button for interrupt messages, buzzer failures
 - Pre-recorded alert message send button
 - Pre-recorded evacuation message send button
 - Call button
 - RJ45 input/output connectors
 - Max absorption @24Vcc 60 mA
 - Typical output level 300 mV
 - Distortion < 1%
 - Frequency response 130 ÷ 19.000Hz
 - Filter LOW CUT -3 dB / 380 Hz
- Size 140x80x200 mm (WxHxD)
Weight 0.77 kg.

8051272180749 **EVO500.B12Z** 0068-CPR-046/2016

IT - Base microfonica da tavolo digitale, 12 zone selezionabili.

Certificato EN54-16.

Da utilizzare in abbinamento all'asta microfonica gooseneck EVO500.GM38 o al microfono palmare EVO500.PTT.

12 tasti per la selezione zone (configurabili singolarmente anche come tasti allarme) + chiamata generale, tasti a rilascio/a ritenuta PTT+LOCK.

Configurazione del livello di priorità (fino a 7).

Led di stato acceso-occupato.

Connettori RJ45 per collegamento con cavi CAT5 e SF-UTP diretti.

Peso: 1,6 Kg.

EN - Digital desk microphone base, 12 selectable zones.

Certificate EN54-16.

To be used in combination with the gooseneck EVO500.GM38 microphone stand or the handheld microphone EVO500.PTT.

12 zone selection keys (individually configurable also as alarm keys) + general call, PTT+LOCK release/retention keys.

Priority level configuration (up to 7). Status LED on-busy.

RJ45 connectors for connection with direct CAT5 and SF-UTP cables.

Weight: 1,6 Kg.

EN54-16
EN54-4

soluzione
modulare
modular
solution

applicabile a
grandi dimensioni
applicable to large
dimensions

55 sorgenti
musicali
55 music
sources

1760 zone
1760 zones

55000W
@100V

fino a 16
EVO+MASTER
up to 16
EVO+MASTER

13 unità slave
per ogni
EVO+MASTER
13 slave units
for each
EVO + MASTER

gestione di linea
ridondata
line
redundant
management

alimentazione
di backup
backup power
supply

amplificatori
di scorta
spare amps

supporto
in loco
support
on site

notifiche
notifications

compatibile
compatible
EVO.BRIDGE

compatibile
compatible
EVO.VISION

EAN13

CODE

matrice a 6 zone
6 zone matrix8051272180794 | **EVO+MASTER** 0068-CPR-012/2017

IT - L'Unità Master è il cuore del sistema EVO+. Matrice a 6 zone espandibili. Gestisce tutti gli eventi, i flussi audio ed effettua il monitoraggio. **Certificato EN54-16.**

- Configurabile, a matrice di 4 linee interne su 110 zone.
- 2x messaggi indipendenti per ogni zona
- Numero illimitato di messaggi indirizzabili sulle zone.
- 2x contatti sorvegliati su unità EVO+MASTER
- 2x contatti sorvegliati sui moduli di zona EVO+ZONAA o EVO+ZONAAB.
- Monitoraggio continuo e indipendente di ogni zona attraverso EVO+ZONAA o EVO+ZONAAB e amplificatore esterno dedicato.
- Monitoraggio continuo e indipendente della doppia linea di una stessa zona(EVO+ZONAAB).
- 2x Ingresso messaggi pre-registrati.
- 2x contatti monitoraggio unità di alimentazione.
- Segnalazione degli stati del sistema mediante contatti relè.

Dimensioni (LxHxP) 483x89x210 mm.
Standard rack (alette incorporate).
Peso: 4,7 kg.

EN - The Master Unit is the heart of the EVO+ system. Matrix with 6 expandable zones. It manages all events, audio streams and performs monitoring. **EN54-16 certified.**

- Configurable, matrix of 4 internal lines on 110 zones.
- 2x independent messages for each zone
- Unlimited number of addressable messages on zones.
- 2x contacts monitored on EVO+MASTER units
- 2x contacts monitored on the EVO+ZONAA or EVO+ZONAAB zone modules.
- Continuous and independent monitoring of each zone through EVO+ZONAA or EVO+ZONAAB and dedicated external amplifier.
- Continuous and independent monitoring of the double line of the same zone (EVO+ZONAAB).
- 2x Input pre-recorded messages.
- 2x power supply unit monitoring contacts.
- Signaling of system statuses by relay contacts.

Size (WxHxD) 483x89x210 mm.
Standard rack (built-in fins).
Weight: 4.7 kg.

unita' di espansione a 8 zone
8 zones expansion system8051272181043 | **EVO+SLAVE** 0068-CPR-012/2017

IT - Espansione 8 zone per EVO+Master. Certificazioni CE: Certificato EN54-16. Numero di certificazione 0068-CPR-012/2017. Fino a 13 unità EVO+Slave possono essere interconnesse per espandere il sistema a 110 zone. Dotato di 8 slot plug-in per la connessione delle schede EVO+ZONAA, EVO+ZONAAB. Funzionamento 24Vdc. Colore nero, serigrafie bianco e arancione. Dimensioni 483x89x210 mm (LxHxP). Peso 4,7 kg. standard rack. Alette incorporate.

EN - Expansion for 8 zones for EVO+Master. Certified EN54-16. Certification Nr 0068-CPR-012/2017. Up to 13 units EVO+Slave can be interconnected to expand the system to 110 zones. Equipped with 8 slot plug-in for the connection of the EVO+ZONAA, EVO+ZONAAB boards. Functioning 24Vdc. Black colour, white and orange screen painting. Size (WxHxD) 483x89x210 mm. Weight 4,7 kg. standard rack. flaps included.

EAN13	CODE
8051272180947	EVO+BSZ 0068-CPR-012/2017 IT - Base microfonica locale. Certificata EN54-16. EN - Local microphone base. EN54-16 certified.
	8051272180954 EVO+BVF 0068-CPR-012/2017 IT - Stazione da parete per vigili del fuoco. Dotata di porta frontale chiudibile con chiave. Può essere utilizzata per annunci vocali di evacuazione. Invio messaggio vocale. - Capsula microfonica dinamica. - Compressore audio automatico. - Monitoraggio capsula microfonica. - Microfono standard PTT. Dimensioni 150x240x70 mm (LxHxP). Peso: 1,4 Kg. EN - Wall firefighters microphone unit. Front door with key lock. It can be used for voice evacuation and/or general announcements. Vocal message. - Dynamic microphone capsule. - Automatic audio compressor. - Microphone capsule monitoring. - Standard PTT microphone. Size 150x240x70 mm (WxHxD). Weight: 1,4 Kg.
	8051272180923 EVO+B1Z 0068-CPR-012/2017 IT - Base microfonica da tavolo a 1 pulsante per chiamate generali o annunci vocali. Dotata di pulsante push-to-talk. Certificato EN54-16. - Capsula microfonica dinamica - Compressore audio automatico - Per connessione centrale-basi usare: CAT6SFTP. - Asta flessibile gooseneck da 40 cm. - Dimensioni senza asta 155x55x180 mm (LxHxP). - Peso: 0,9 Kg. EN - 1 button desktop microphone base for general calls or voice announcements. Equipped with push-to-talk button. EN54-16 certified. - Dynamic microphone capsule - Automatic audio compressor - For central connection-bases use: CAT6SFTP. - 40 cm gooseneck flexible rod. - Size without rod 155x55x180 mm (WxHxD). - Weight: 0,9 Kg.
	8051272180930 EVO+B6Z 0068-CPR-012/2017 IT - Base microfonica digitale da tavolo a 6 zone. Dotata di pulsante push-to-talk per chiamate alle zone. Per annunci vocali di evacuazione e/o generali. Certificato EN54-16. - Capsula microfonica dinamica - Compressore audio automatico - Per connessione centrale-basi usare: CAT6SFTP. - Asta flessibile gooseneck da 36 cm. Dimensioni senza asta 200x60x185 mm (LxHxP). Peso: 1,2 Kg. EN - 6-zone digital desktop microphone base. Equipped with push-to-talk button for zone calls. For evacuation and/or general voice announcements. EN54-16 certified. - Dynamic microphone capsule - Automatic audio compressor - For central connection-bases use: CAT6SFTP. - 36 cm gooseneck flexible rod. Size without rod 200x60x185 mm (WxHxD). Weight: 1,2 Kg.
	8051272180916 EVO+B108Z 0068-CPR-012/2017 IT - Base microfonica digitale da tavolo programmabile, fino a 999 combinazioni. Con pulsante push-to-talk per chiamate alle zone. Certificato EN54-16. Può essere utilizzata per annunci vocali di evacuazione e/o generali. - Capsula microfonica dinamica. - Compressore audio automatico. - Asta flessibile gooseneck da 36 cm. - Dimensioni senza asta 200x60x185 mm (LxHxP). Peso: 1,6 Kg. EN - Programmable digital desktop microphone base, up to 999 combinations. With button push-to-talk for calls to zones. EN54-16 certified. It can be used for evacuation and/or general voice announcements. - Dynamic microphone capsule. - Automatic audio compressor. - 36 cm gooseneck flexible rod. - Size without rod 200x60x185 mm (WxHxD). Weight: 1,6 Kg.

EAN13 CODE



8051272181029 **EVO+PTTR** 0068-CPR-012/2017

IT - Microfono VVF, modulare.
Certificato **EN54-16**.

EN - FD microphone, modular.
EN54-16 certified.



8051272188011 **EVO.CVF**

IT - Cassetta rossa da parete per base
EVO500.BVF e EVO500.PTT.
Dimensioni (LxHxP) 265x300x130 mm.

EN - Red wall box for EVO500 base.
BVF and EVO500. PTT.
Size (WxHxD) 265x300x130 mm.



8051272188363 **EVO.PAT**

IT - Pulsante a scatto per
azionamento impianto di allarme
vocale, contenuto in cassetta con
sportello di sicurezza.
Comprensivo di contatto e chiave
di sicurezza per blocco sportello.
Grado di protezione: IP55.
Classe isolamento: II.
Colore: rosso RAL3000.
Dimensioni (LxHxP):
108x180x100 mm.

EN - Snap button for voice alarm
system operation, contained in a box
with security door.
Including contact and security key
for door lock. Degree of protection:
IP55.
Insulation class: II.
Red color: RAL3000.
Size (WxHxD):
108x180x100 mm.

EAN13

CODE

schede di monitoraggio zone A zone monitoring cards A

8051272181081

EVO+ZONAA 068-CPR-012/2017



IT - Modulo di zona con uscita altoparlanti singola. Esegue il monitoraggio dell'amplificatore e delle linee altoparlanti. La scheda deve essere inserita negli appositi slot dell'unità EVO+Master o dell'espansione a 8 zone EVO+Slave.

Caratteristiche:

- Indirizzamento automatico
- Gestione potenza fino a 500W RMS
- Monitoraggio del funzionamento linea altoparlanti A
- Monitoraggio dei parametri di funzionamento amplificatori
- Passaggio automatico all'amplificatore di riserva nel caso di guasto dell'amplificatore principale
- 2 generatori di messaggi monitorati, integrati
- Uscita bilanciata per gli amplificatori di zona
- Dimensioni 85x3,5x134 mm (LxHxP)
- Peso 0,1 Kg
- Colore silver

EN - Zone module with single speaker output. Monitors the amplifier and speaker lines. This board must be plugged into a slot on the main unit EVO+Master or in the expansions to 8 zones EVO+Slave.

Main Features:

- Automatic addressing
- Power management up to 500W RMS
- Monitoring of the loudspeakers line A
- Monitoring of the amplifiers operation parameters
- Automatic switch to the backup amplifier in case of faults of the main amplifier
- 2 monitored message players, integrated
- Balanced output to feed zone amplifiers
- Status LED
- Dimensions (WxHxD) 85x3,5x134 mm
- Silver colour
- Weight 0,1 Kg

schede di monitoraggio zone AB zone monitoring cards AB

8051272181098

EVO+ZONAB 068-CPR-012/2017



IT - Modulo di zona con uscita altoparlanti ridondata. Esegue il monitoraggio dell'amplificatore e delle linee altoparlanti. La scheda deve essere inserita negli appositi slot dell'unità EVO+Master o dell'espansione a 8 zone EVO+Slave. Da prevedere nelle configurazioni dove sono richieste due linee di altoparlanti nella stessa zona (linea A).

Caratteristiche:

- Indirizzamento automatico
- Gestione potenza fino a 500W RMS
- Monitoraggio del funzionamento linee altoparlanti (A+B)
- Monitoraggio dei parametri di funzionamento amplificatori
- Passaggio automatico all'amplificatore di riserva nel caso di guasto dell'amplificatore principale
- 2 generatori di messaggi monitorati, integrati
- Uscita bilanciata per gli amplificatori di zona
- Dimensioni 85x3,5x134 mm (LxHxP)
- Peso 0,1 Kg
- Colore Silver

EN - Zone module with redundant speaker output. Monitors the amplifier and speaker lines. This board must be plugged into a slot on the main unit EVO+Master or in the expansions to 8 zones EVO+Slave. To plan in configurations where two loudspeaker lines are required in the same zone (line A).

Main Features:

- Automatic addressing
- Power management up to 500W RMS
- Monitoring of the loudspeakers lines (dual lines, A+B)
- Monitoring of the amplifiers operation parameters
- Automatic switch to the backup amplifier in case of faults of the main amplifier
- 2 monitored message players, integrated
- Balanced output to feed zone amplifiers
- Status LED
- Dimensions (WxHxD) 85x3,5x134 mm
- Weight 0,1 Kg
- Silver colour

EAN13

CODE

amplificatori modulari
modulars amps8051272180879 | **EVO+A120** 068-CPR-012/2017

IT - Amplificatore in classe D, modulare. **Certificato EN54-16.**
Potenza 120 W RMS.
Dimensioni (LxHxP) mm 81x132x365.
Peso 4,35 Kg.

EN - Class D amplifier, modular. **EN54-16 certified.**
Power 120 W RMS.
Size (WxHxD) mm 81x132x365.
Weight 4,35 Kg.

8051272180886 | **EVO+A240** 068-CPR-012/2017

IT - Amplificatore in classe D, modulare. **Certificato EN54-16.**
Potenza 240 W RMS.
Dimensioni (LxHxP) mm 81x132x365.
Peso 5,8 Kg.

EN - Class D amplifier, modular. **EN54-16 certified.**
Power 240 W RMS.
Size (WxHxD) mm 81x132x365.
Weight 5,8 Kg.

8051272180893 | **EVO+A480** 068-CPR-012/2017

IT - Amplificatore in classe D, modulare. **Certificato EN54-16.**
Potenza 480 W RMS.
Dimensioni (LxHxP) mm 162x132x365.
Peso 6,5 Kg.

EN - Class D amplifier, modular. **EN54-16 certified.**
Power 480 W RMS.
Size (WxHxD) mm 162x132x365.
Weight 6,5 Kg.

alimentatori switching
switching power supply8051272181036 | **EVO+PW24** 068-CPR-012/2017

IT - Alimentatore switching 24Vcc, modulare. **Certificato EN54-16.**

EN - Switching power supply 24Vdc, modular. **EN54-16 certified.**

dispositivi duali
dual devices8051272189711 | **EVO+ASPLIT**

IT - Dispositivo per il collegamento di due basi microfoniche EVO+B1Z, EVO+B6Z, EVO+B108Z ad una matrice EVO+MASTER. Standard DIN. Dimensioni 70x90x58 (LxHxP) mm . Peso 0,13 Kg.

EN - Device for connecting two microphone bases EVO+B1Z, EVO+B6Z, EVO+B108Z to an EVO+MASTER matrix. DIN standard. Size 70x90x58 (WxHxD) mm . Weight 0,13 Kg.

8051272189971 | **EVO+BSPLIT**

IT - Dispositivo per il collegamento da 1 a 7 basi microfoniche EVO+B1Z, EVO+B6Z, EVO+B108Z ad una matrice EVO+Master. Uscite protette. LED di stato: verde = presenza tensione uscita rosso = uscita in guasto Standard DIN. Dimensioni 72x90x63 (LxHxP) mm . Peso 0,13 Kg.

EN - Device for connecting from 1 to 7 microphone bases EVO+B1Z, EVO+B6Z, EVO+B108Z to an EVO+Master matrix. Protected outputs. Status LED: green = presence of output voltage red = faulty output DIN standard. Size 72x90x63 (WxHxD) mm . Weight 0,13 Kg.

EAN13 CODE

8051272180961 **EVO+C5P** 068-CPR-012/2017



IT - Kit contenitore 3U standard rack, modulare a 5 moduli.
Certificato EN54-16.
Kit composto da:
- contenitore 5 moduli
- 4 pannelli ciechi

EN - Kit rack 3 units standard case modular with 5 modules.
EN54-16 certified.
Kit includes:
- container 5 modules
- 4 blind panels

8051272181074 **EVO+SWT8X4** 068-CPR-012/2017



IT - Switch 8IN, 4OUT, modulare.
Certificato EN54-16.

EN - Switch 8IN, 4OUT, modular.
EN54-16 certified.

8051272181012 **EVO+PM5** 068-CPR-012/2017

IT - Pannello monitor audio da 2U standard rack. A 5 canali, equipaggiato con altoparlante e selettore. **Certificato EN54-16.**

EN - Audio monitor panel, 2U standard rack. 5-channels, equipped with speaker and selector. **EN54-16 certified.**

8051272180992 **EVO+ETH2** 068-CPR-012/2017



IT - Il modulo Loop, da installare nell'unità EVO+Master permette di interconnettere due o più sistemi EVO+. **Certificato EN54-16.** Ogni contenuto audio può essere inoltrato e riprodotto in ogni zona oppure.
- porta di rete RJ45 schermata
- collegamento dati totalmente supervisionato secondo normativa

EN - The Loop module, to be installed in the EVO+Master unit, allows you to interconnect two or more EVO+ systems. **EN54-16 certified.** Each audio content can be forwarded and played in any zone or.
- shielded network port RJ45
- data connection fully supervised according to regulations

8051272180909 **EVO+AUXINMZ** 068-CPR-012/2017



IT - Pannello ingresso musica di zona, modulare.
Certificato EN54-16.

EN - Zone music input panel, modular.
EN54-16 certified.

8051272183887 **EVO.SE**



IT - Silenziatore elettronico da barra DIN. Interrompe il segnale degli amplificatori dell'impianto esistente, interrompe l'alimentazione degli amplificatori esistenti. Supervisione linea di comando e alimentazione apparecchiature. 9 moduli DIN. Dimensioni (LxHxP) 159x90x70 mm. Peso: 0,5 Kg.

EN - Electronic silencer DIN rail. Interrupt the signal of the amplifiers of the existing system, interrupts the power supply of the existing amplifiers. Supervision of the control line and equipment power supply. 9 DIN modules. Size (WxHxD) 159x90x70 mm. Weight: 0,5 Kg.

EAN13

CODE



8051272189469

EVO+FCMONO



IT - Convertitore seriale - fibra ottica monomodale.

EN - Serial converter from network to optic fiber single-mode.



8051272189476

EVO+FCMULTI



IT - Convertitore seriale - fibra ottica multimodale.

EN - Serial converter from network to optic fiber multi-mode.

**caricabatterie per sistemi certificati EN54
battery charger for EN54 certified systems**

8051272181005

EVO+MS150



IT - Carica batterie 24V per sistemi di evacuazione. **Certificato EN54-4.** 1U a rack. Corrente max 150A. Spegnimento automatico in caso di tensione della batteria troppo bassa. Protezione contro le sovratensioni. Protezione contro polarità errata. Protezione contro i cortocircuiti. Uscite protette mediante fusibili. L'alimentatore esegue ogni 4 ore una misurazione della resistenza della batteria. Fornito di sensore della temperatura per la regolazione della tensione.

Connessioni:
- Collegamenti in ingresso (alla batteria) terminale a vite.
- Collegamenti in uscita (al sistema) 10 x connettore a vite collegabile.
- 6 uscite principali per il sistema, ciascuna con il relativo fusibile.
- 3 uscite ausiliarie per le periferiche.
- Relè di guasto.
Dimensioni 430x88x260 mm (LxHxP).
Peso: 6 kg.

EN - 24V battery charger for evacuation systems. **EN54-4 certified.** 1U per rack. Max current 150A.

Automatic shutdown in case of too low battery voltage. Surge protection. Protection against incorrect polarity.

Protection against short circuits. Outputs protected by fuses. The power supply performs a battery resistance measurement every 4 hours. Included with temperature sensor for voltage regulation.

Connections:
- Input connections (to the battery) screw terminal.
- Output connections (to the system) 10 x connectable screw connector.
- 6 main outputs for the system, each with its own fuse.
- 3 auxiliary outputs for peripherals.
- Fault relays.
Size 430x88x260 mm (WxHxD).
Weight: 6 kg.

EAN13

CODE

batterie per sistemi certificati EN54
batteries for EN54 certified systems



8052015550690	BATTERIA12AH 12 Ah - EN60896-21/22
8051272183573	BATTERIA26AH 26 Ah - EN60896-21/22
8051272183580	BATTERIA40AH 40 Ah - EN60896-21/22
8051272183597	BATTERIA69AH 69 Ah - EN60896-21/22
8051272183603	BATTERIA93AH 93 Ah - EN60896-21/22
8051272183566	BATTERIA125AH 125 Ah - EN60896-21/22

IT - Batterie per sistema di evacuazione.

EN - Batteries for evacuation system.

UPS per sistemi certificati EN54
UPS for EN54 certified systems

8051272180831 **EVO+3X9** 0068-CPR-012/2017



IT - UPS professionale rack 19" per l'alimentazione senza interruzione (ON-LINE). **Certificato EN54-16.** Doppia conversione, tensione di ingresso e di uscita 230V 50Hz monofase, potenza disponibile 1500VA / 1350W a Cos.phi. 0.8, commutatore statico, RS232 e USB e spegnimento di emergenza EPO, scheda uscita segnali anomalia. **3 accumulatori da 12V-9Ah. 2 unità rack modulari.** Peso: 17 Kg.

EN - Professional 19" rack UPS for uninterrupter power supply (ON-LINE). **EN54-16 certified.** Double conversion, input and output voltage 230V 50Hz single-phase, available power 1500VA / 1350W at Cos.phi. 0.8, static switch, RS232 and USB and EPO emergency shutdown, anomaly signal output board. **3 x 12V-9Ah accumulators. 2 modular rack units.** Weight: 17 Kg.

8051272180824 **EVO+3X55** 0068-CPR-012/2017



IT - Kit UPS professionale rack 19" per l'alimentazione senza interruzione (ON-LINE). **Certificato EN54-16.** Doppia conversione, tensione di ingresso e di uscita 230V 50Hz monofase, potenza disponibile 1500VA / 1350W a Cos.phi. 0.8, commutatore statico, RS232 e USB e spegnimento di emergenza EPO, scheda uscita segnali anomalia. **1 ripiano con 3 batterie 12V-57Ah, interruttore di sezionamento. 11 unità rack modulari.** Peso: 70 Kg.

EN - 19" Professional Rack UPS Kit for Uninterrupted Power (ON-LINE). **EN54-16 certified.** Double conversion, input and output voltage 230V 50Hz single-phase, available power 1500VA / 1350W at Cos.phi. 0.8, static switch, RS232 and USB and EPO emergency shutdown, anomaly signal output board. **1 shelf with 3 batteries 12V-57Ah, sectioning switch. 11 modular rack units.** Weight: 70 Kg.

8051272180817 **EVO+3X100** 0068-CPR-012/2017



IT - Kit UPS professionale rack 19" per l'alimentazione senza interruzione (ON-LINE). **Certificato EN54-16.** Doppia conversione, tensione di ingresso e di uscita 230V 50Hz monofase, potenza disponibile 1500VA / 1350W a Cos.phi. 0.8, commutatore statico, RS232 e USB e spegnimento di emergenza EPO, scheda uscita segnali anomalia. **1 ripiano con 3 batterie 12V-100Ah, interruttore di sezionamento. 11 unità rack modulari.** Peso: 103 Kg.

EN - 19" Professional Rack UPS Kit for Uninterrupted Power (ON-LINE). **EN54-16 certified.** Double conversion, input and output voltage 230V 50Hz single-phase, available power 1500VA / 1350W at Cos.phi. 0.8, static switch, RS232 and USB and EPO emergency shutdown, anomaly signal output board. **1 shelf with 3 batteries 12V-100Ah, sectioning switch. 11 modular rack units.** Weight: 103 Kg.

EAN13

CODE

8051272180855 **EVO+6X9** 0068-CPR-012/2017

IT - Kit UPS professionale rack 19" per l'alimentazione senza interruzione (ON-LINE). **Certificato EN54-16**. Doppia conversione, tensione di ingresso e di uscita 230V 50Hz monofase, potenza disponibile 1500VA / 1350W a Cos.phi. 0.8, commutatore statico, RS232 e USB e spegnimento di emergenza EPO, scheda uscita segnali anomalia.
1 ripiano 6 accumulatori da 12V-9Ah, interruttore di sezionamento.
2+3 unità rack modulari.
Peso: 17 Kg.

EN - 19" Professional Rack UPS Kit for Uninterrupted Power (ON-LINE). **EN54-16 certified**. Double conversion, input and output voltage 230V 50Hz single-phase, available power 1500VA / 1350W at Cos.phi. 0.8, static switch, RS232 and USB and EPO emergency shutdown, anomaly signal output board.
1 shelf 6 accumulators of 12V-9Ah, disconnection switch.
2+3 modular rack units.
Weight: 17 Kg.

8051272180848 **EVO+6X100** 0068-CPR-012/2017

IT - Kit UPS professionale rack 19" per l'alimentazione senza interruzione (ON-LINE). **Certificato EN54-16**. Doppia conversione, tensione di ingresso e di uscita 230V 50Hz monofase, potenza disponibile 1500VA / 1350W a Cos.phi. 0.8, commutatore statico, RS232 e USB e spegnimento di emergenza EPO, scheda uscita segnali anomalia.
2 ripiani con 6 batterie 12V-100Ah, interruttore di sezionamento.
20 unità rack modulari.
Peso: 193 Kg.

EN - 19" Professional Rack UPS Kit for Uninterrupted Power (ON-LINE). **EN54-16 certified**. Double conversion, input and output voltage 230V 50Hz single-phase, available power 1500VA / 1350W at Cos.phi. 0.8, static switch, RS232 and USB and EPO emergency shutdown, anomaly signal output board.
2 shelves with 6 batteries 12V-100Ah, disconnection switch.
20 modular rack units.
Weight: 193 Kg.

8051272180862 **EVO+9X9** 0068-CPR-012/2017

IT - Kit UPS professionale rack 19" per l'alimentazione senza interruzione (ON-LINE). **Certificato EN54-16**. Doppia conversione, tensione di ingresso e di uscita 230V 50Hz monofase, potenza disponibile 1500VA / 1350W a Cos.phi. 0.8, commutatore statico, RS232 e USB e spegnimento di emergenza EPO, scheda uscita segnali anomalia.
1 ripiano 9 accumulatori 12V-9Ah, interruttore di sezionamento.
2+3 unità rack modulari Peso: 43 Kg.

EN - 19" Professional Rack UPS Kit for Uninterrupted Power (ON-LINE). **EN54-16 certified**. Double conversion, input and output voltage 230V 50Hz single-phase, available power 1500VA / 1350W at Cos.phi. 0.8, static switch, RS232 and USB and EPO emergency shutdown, anomaly signal output board.
1 shelf 9 accumulators 12V-9Ah, disconnection switch.
2+3 modular rack units
Weight: 43 Kg.

8051272180800 **EVO+12X9** 0068-CPR-012/2017





IT - Kit UPS professionale rack 19" per l'alimentazione senza interruzione (ON-LINE). **Certificato EN54-16**. Doppia conversione, tensione di ingresso e di uscita 230V 50Hz monofase, potenza disponibile 1500VA / 1350W a Cos.phi. 0.8, commutatore statico, RS232 e USB e spegnimento di emergenza EPO, scheda uscita segnali anomalia.
1 ripiano 12 accumulatori 12V-9Ah, interruttore di sezionamento.
2+3 unità rack modulari Peso: 51 Kg.

EN - 19" Professional Rack UPS Kit for Uninterrupted Power (ON-LINE). **EN54-16 certified**. Double conversion, input and output voltage 230V 50Hz single-phase, available power 1500VA / 1350W at Cos.phi. 0.8, static switch, RS232 and USB and EPO emergency shutdown, anomaly signal output board.
1 shelf 12 accumulators 12V-9Ah, disconnection switch.
2+3 modular rack units
Weight: 51 Kg.

EAN13

CODE

armadi rack cablati secondo normativa EN54
racks cabinets wired according to EN54

	8052015550430	RACK12UEVA 12 unit - (LxHxP) 600x643x600 mm
	8052015550447	RACK22UEVA 22 unit - (LxHxP) 600x1166x600 mm
	8052015550454	RACK32UEVA 32 unit - (LxHxP) 600x1610x600 mm
	8052015550461	RACK42UEVA 42 unit - (LxHxP) 600x2055x600 mm

IT - Mobile metallico a norme rack.
Lamiera d'acciaio con una forte capacità di carico, verniciata a polvere.
Composto da 2 fianchi, tetto, fondo, porta con chiave, ruote, pannello di chiusura posteriore. Fianchi laterali smontabili con chiusura a chiave. IP40.
Messa a terra, kit di viti per il montaggio degli accessori incluse.
Fornito montato, cablato, programmato e collaudato secondo norme EN54.
Completo di tutti gli accessori cavi, connettori, ecc... occorrenti alla perfetta installazione e cablaggio delle apparecchiature previste in offerta.
Prezzo comprensivo di manodopera per il montaggio, la programmazione, la taratura dei dispositivi installati ed il collaudo in fabbrica.
Fornito con documentazione relativa e manuali. Colore: nero RAL9005.

EN - Metal cabinet to standard rack units.
Steel sheet with a strong load capacity, powder coated. Composed of 2 sides, roof, bottom, door with key, wheels, rear locking panel. Removable side panels with key lock. IP40..
Grounding, kit includes screws for mounting accessories included.
Included assembled, wired, programmed and tested according to EN54 standards.
Complete with all the cable accessories, connectors, etc ... necessary for the perfect installation and wiring of the equipment provided on offer.
Price including labor for assembly, programming, calibration of installed devices and factory testing.
Included with related documentation and manuals.
Color: black RAL9005.





Giove iControl

EVO.VISION

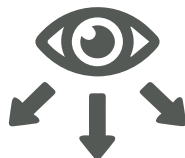

SICUREZZA E CONTROLLO DA LOCALE O DA REMOTO
EMERGENZE, GUASTI, VARIAZIONI DI STATO IMMEDIATAMENTE NOTIFICATE
SECURITY AND CONTROL FROM LOCAL OR REMOTE EMERGENCIES
FAULTS, CHANGES IN STATUS IMMEDIATELY NOTIFIED



NELL'IMMAGINE SOTTO UN ESEMPIO LINK TRA CENTRALI IN DIVERSI EDIFICI
IN THE IMAGE BELOW, AN EXAMPLE LINK BETWEEN CENTRALS IN DIFFERENT BUILDINGS

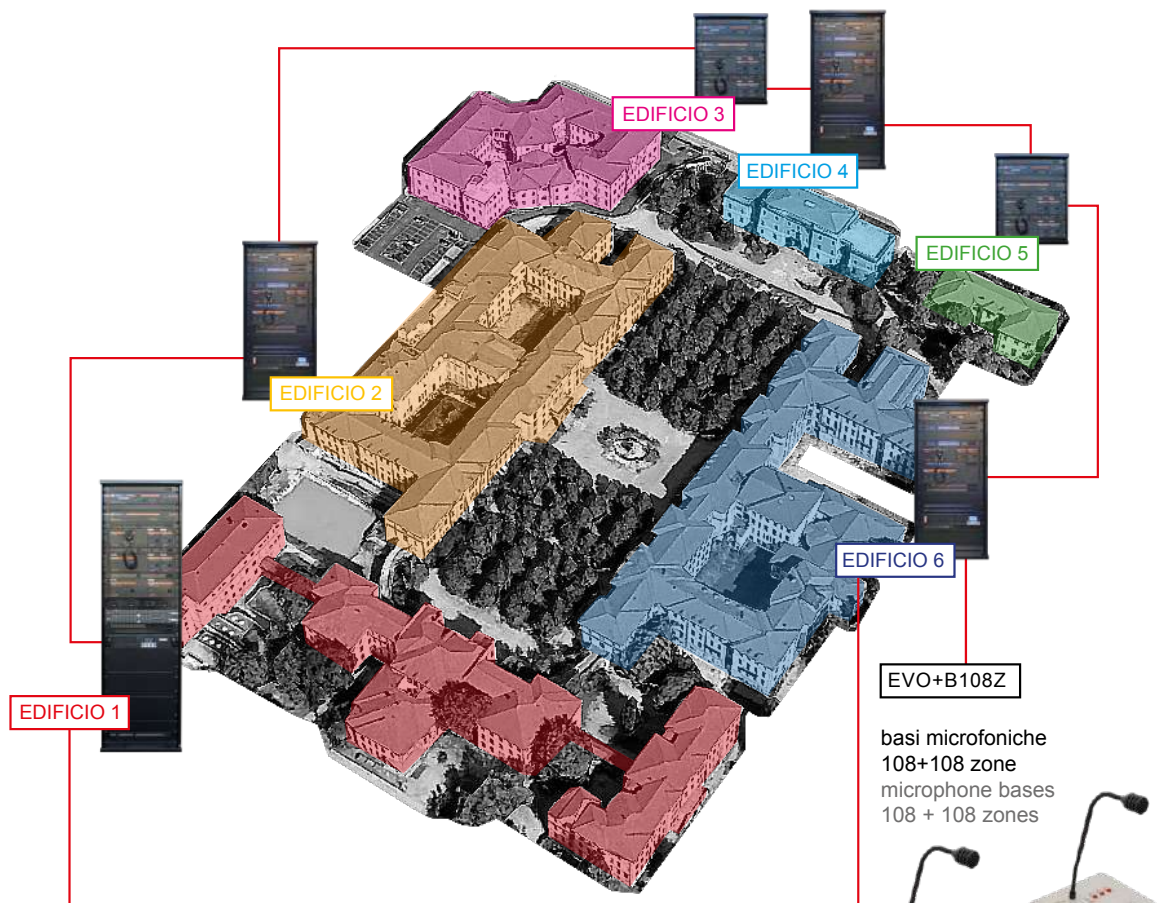

FINO A 1760 ZONE INDIPENDENTI
55 SORGENTI MUSICALI
UP TO 1760 INDEPENDENT ZONES
55 MUSICAL SOURCES



Speakers with
Style



RECOMMENDED FOR	EAN13	CODE
-----------------	-------	------



8051272184136	INVISIBLE65
8051272184143	INVISIBLE65T
8052015550775	SUBINVISIBLE50
8052015551000	SUBINVISIBLE50T



	INVISIBLE65	INVISIBLE65T	SUBINVISIBLE50	SUBINVISIBLE50T
Descrizione / Description	Diffusore (trasduttore) per retro superfici piane e rigide, HiFi / Speaker (transducer) for retro flat and rigid surfaces, HiFi		Subwoofer (trasduttore) per retro superfici piane e rigide, HiFi / Subwoofer (transducer) for flat and rigid back surfaces, HiFi	
Driver	1,25" (32mm)	1,25" (32mm)	2,25" (57mm).	2,25" (57mm).
Magnete / Magnet	neodimio / neodymium	neodimio / neodymium	neodimio / neodymium	neodimio / neodymium
Membrana / Diaphragm	ABS	ABS		
Potenza RMS / musicale RMS / Music Power	40W/80W	---	50W/100W	---
Potenza nominale / peak Nominal power / peak	---	2/4/8/16/32W 60W peak, max 100dB	---	5/10/20/50W RMS 100W peak
Amplificazione consigliata Recommended amplification	da 20 a 60W RMS 20 to 60W RMS	---	da 40 a 100W RMS 40 to 100W RMS	---
Impedenza / Tensione trasformatore Impedance / Transformer voltage	8Ω	100V	8Ω	100V
Risposta in frequenza / Sensibilità Frequency Response / Sensitivity	60-20000 Hz +6dB / 85dB	60-20000 Hz +6dB / 85dB	40-500 Hz +8dB / 85dB	40-500 Hz +8dB / 85dB
Dimensioni (LxHxP) / Size (WxHxD)	58,5x68,5x20 mm	58,5x68,5x20 mm	115x46x115 mm	115x46x115 mm
Peso / Weight	0,22 kg	0,22 kg	1,2 kg	1,2 kg
Fissaggio / Fixing	con 4 viti o adesivo per vetro with 4 screws or glass adhesive		con 4 viti o adesivo per vetro with 4 screws or glass adhesive	

La resa acustica è direttamente proporzionale alla rigidità ed alla tipologia del materiale usato per la vibrazione
The acoustic performance is directly proportional to the rigidity and the type of material used for vibration

esempio di superfici / example of surfaces
vetro: ottima / glass: excellent
legno: buona / Wood: good
cartongesso: sufficiente / drywall: sufficient

murature, laterizi, cemento: non adatte / masonry, bricks, cement: not suitable
polistirolo o simili: non adatti / polystyrene or similar: not suitable

Note

Attenzione: il trasformatore dovrà essere installato ad una distanza di almeno 1mt dall'Invisible o vicino all'amplificatore/quadro rack.
Attention: the transformer must be installed at a distance of at least 1 meter from the INVISIBLE or near the amplifier / rack panel.

--

Attenzione il trasformatore non dovrà essere installato sulla superficie vibrante
Attention the transformer should not be installed on the vibrating surface but preferably near the amplifier.



RECOMMENDED FOR

EAN13

CODE



8051272183993	GHOST930
8051272186345	SC930
8052015551017	GHOST930SUB



GHOST930



SC930

	GHOST930	GHOST930SUB
Descrizione / Description	Diffusore per retro superfici piane e rigide, HiFi Speaker for retro flat and rigid surfaces, HiFi	Subwoofer per retro superfici piane e rigide, HiFi Subwoofer for rear of flat and rigid surfaces
Woofer	4 trasduttori magneto dinamici a gamma larga 4 wide range dynamic magnet transducers	2 trasduttori magneto dinamici per subwoofer 2 dynamic sub-transducers
Membrana / Diaphragm	ABS	ABS
Potenza RMS / Musicale RMS / Music Power	160W / 320W	100W / 200W
Amplificazione consigliata Recommended amplification	da 80 a 200W RMS 80 to 200W RMS	da 80 a 200W RMS 80 to 200W RMS
Impedenza / Impedance	8Ω	4Ω
Risposta in frequenza Frequency response	60-20000 Hz +-6dB	40-200 Hz +-6dB
Sensibilità / Sensibility	86dB	86dB
Dimensioni senza controcassa (LxHxP) Size without casing (WxHxD)	370x550x40 mm	370x550x40 mm
Dimensioni con controcassa SC930 (LxHxP) Size with casing SC930 (WxHxD)	370x550x68 mm	370x550x68 mm
Foro da incasso / Recessed hole	(LxHxP) / (WxHxD) 370x550x68 mm	(LxHxP) / (WxHxD) 370x550x68 mm
Peso / Weight	1,5 kg	2,5 kg
Colore / Color		
Cabinet	legno / wood	legno / wood
	esterno verniciato bianco, interno legno naturale / exterior white painted wood, interior natural wood	
Fissaggio / Fixing	a vite sul cartongesso, a muro tramite SC930 drywall screw, wall through, SC930	a vite sul cartongesso, a muro tramite SC930 drywall screw, wall through, SC930
Note	Installabile sottotraccia anche su muro (laterizi, cemento) tramite apposita controcassa SC930 Can be installed under the track also on the wall (bricks, concrete) through a special SC930 casing	



RECOMMENDED FOR	EAN13	CODE
	8051272182514	GIADA503B* nero / black
	8051272182521	GIADA503S* silver
	8051272182538	GIADA503W* bianco / white
	8051272180015	GIADA506 bianco / white
	8051272182552	GIADA506.R (min 10pz)
	8051272189438	GIADA506B nero / black
	8052015550140	GIADA506F bianco / white
	8052015550324	GIADA506F.R (min 10pz)
	8051272182569	GIADA506T bianco / white
	8051272182576	GIADA506T.R (min 10pz)
	8051272189445	GIADA506TB nero / black
	8052015550157	GIADA506TF bianco / white
	8052015550331	GIADA506TF.R (min 10pz)
	8052015551086	RG506FB retina black per GIADA506F/TF

GIADA503S (silver)



GIADA503W (white)



GIADA503B (black)



GIADA506/506T (white)



GIADA506B/506TB (black)



GIADA506F/506TF



	GIADA503	GIADA506	GIADA506F	GIADA506T	GIADA506TF
Descrizione / Description	Diffusore rettangolare, da incasso. Rectangular speaker, recessed.	Diffusore quadrato, da incasso full range, HiFi Square speaker, full range recessed, HiFi	incasso frameless recessed frameless	Diffusore quadrato, da incasso full range, HiFi Square speaker, full range recessed, HiFi	incasso frameless recessed frameless
Altoparlante / Speaker	ellittico da 7x3 cm 7x3 cm elliptical	---	---	---	---
Woofer	---	7,5 cm	7,5 cm	7,5 cm	7,5 cm
Membrana / Diaphragm	---	polypropylen	polypropylen	polypropylen	polypropylen
Potenza RMS / musicale RMS / Music Power	10W / 20W	30W / 60W	30W / 60W	---	---
Potenza nominale / peak Nominal power / peak	---	---	---	8W / 16W max 93dB	8W / 16W max 93dB
Amplificazione consigliata Recommended amplification	da 10 a 20W RMS 10 to 20W RMS	da 10 a 40W RMS 10 to 40W RMS	da 10 a 40W RMS 10 to 40W RMS	---	---
Impedenza / Tensione trasformatore Impedance / Transformer voltage	8Ω	8Ω	8Ω	100V	100V
Risposta in frequenza / Sensibility Frequency response / sensitivity	150-18000Hz/85dB	65-18000Hz/85dB	65-18000Hz/85dB	65-18000Hz/85dB	65-18000Hz/85dB
Dimensioni (LxHxP) / Size (WxHxD)	72x42x55 mm	125x125x48 mm	125x125x48 mm	125x125x48 mm	125x125x48 mm
Incasso / built-in box	503	506E	506E	506E	506E
Peso / Weight	0,3 kg	0,35 kg	0,35 kg	0,40 kg	0,40 kg
Colori disponibili / Available colors	black, silver, white	white RAL 9016 black RAL 9011	white RAL 9016	white RAL 9016 black RAL 9011	white RAL 9016
Cabinet	metallo / metal	ABS V0 con griglia di protezione zincata verniciata ABS V0 with painted galvanized grille			
Note	adattatore per placca (vedi pag. 54-55) Non compatibile con AD15 e AD16 adapter for plate series (see p. 54-55) Not compatible with AD15 and AD16	---	---	---	---



RECOMMENDED FOR	EAN13	CODE
	8051272180022	GIADA10 bianco / white
	8051272188691	GIADA10B nero / black
	8051272182064	GIADA10.R (min 10pz)
	8052015550164	GIADA10F bianco / white
	8052015550300	GIADA10F.R (min 10pz)
EN54-24	8051272180039	GIADA10T bianco / white
EN54-24	8051272188707	GIADA10TB nero / black
	8052015550171	GIADA10TF bianco / white
	8052015550317	GIADA10TF.R (min 10pz)
	8052015551079	RG10FB retina black per GIADA10F/TF
	8051272181180	SR10
	8051272181197	SR10ENX bianco / white
	8051272189261	SR10ENXB nero / black

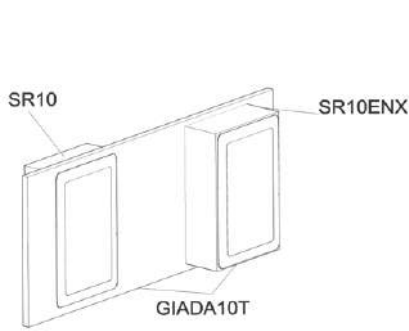

	GIADA10	GIADA10F	GIADA10T	GIADA10TF
Descrizione / Description	Diffusore rettangolare, da incasso HiFi, 2 vie Rectangular speaker, recessed HiFi, 2 way	incasso frameless recessed frameless	Diffusore rettangolare, da incasso HiFi, 2 vie Rectangular speaker, recessed HiFi, 2 way	incasso frameless recessed frameless
Certificato EN54 / EN54 Certificate	---	---	si / yes	---
Woofers	11 cm	11 cm	11 cm	11 cm
Tweeter	1,3 cm mylar	1,3 cm mylar	1,3 cm mylar	1,3 cm mylar
Potenza RMS / musicale / RMS / Music Power	30W/60W	30W/60W	---	---
Potenza nominale / peak Nominal power / peak	---	---	1,5/3/6W 12W peak	1,5/3/6W 12W peak
Amplificazione consigliata Recommended amplification	da 10 a 40W RMS 10 to 40W RMS	da 10 a 40W RMS 10 to 40W RMS	---	---
Impedenza / Tensione trasformatore Impedance / Transformer voltage	8Ω	8Ω	100V	100V
Risposta in frequenza / Sensibilità Frequency Response / Sensitivity	60-20000Hz/88dB	60-20000Hz/88dB	70-20000Hz-10dB/87dB max 1mt 94dB	70-20000Hz-10dB/87dB max 1mt 94dB
Angolo di dispersione / Dispersion angle	120° (V/O)	120° (V/O)	120° (V/O)	120° (V/O)
Dimensioni (LxHxP) / Size (WxHxD)	147x222x60 mm	147x222x60 mm	147x222x65 mm	147x222x65 mm
Foro da incasso (LxH) / Recessed hole (WxH)	120x195 mm	120x195 mm	120x195 mm	120x195 mm
Peso / Weight	0,9 kg	0,9 kg	1,1 kg	1,1 kg
Colori disponibili / Available colors	bianco / white RAL 9003 nero / black RAL 9011	bianco / white RAL 9003	bianco / white RAL 9003 nero / black RAL 9011	bianco / white RAL 9003
Cabinet	ABS V0 con griglia di protezione zincata verniciata ABS V0 with painted galvanized grille			
Incasso su muratura / Recessed on masonry	SR10 (pag.180)	SR10 (pag.180)	SR10 (pag.180)	SR10 (pag.180)
Incasso su cartongesso / Recessed on plaster-board	non servono accessori, il diffusore nel retro è dotato di ganci per l'ancoraggio stabile no accessories needed, the speaker is provided with hook shaped anchors for stable fixing in the rear			
Installazione a parete (sbalzo) / Wall installation (overhang)	---	---	SR10ENX (pag.180)	---



RECOMMENDED FOR	EAN13	CODE
	8051272182118	GIADA13L
	IP44 8051272182125	GIADA13L.IP
	8051272182132	GIADA13L.R (min 10pz)
	8051272182163	GIADA13TL
	IP44 8051272182170	GIADA13TL.IP
	8051272182187	GIADA13TL.R (min 10pz)
	8051272182194	GIADA16
	8051272182200	GIADA16.R (min 10pz)
	8051272182323	GIADA16TL EOL
	IP44 8051272182330	GIADA16TL.IP EOL
	8051272182347	GIADA16TL.R EOL (min 10pz)



	GIADA13L	GIADA13TL	GIADA16	GIADA16TL
Descrizione / Description	Diffusore rettangolare, da incasso HiFi, 2 vie / Rectangular speaker, 2 way built-in, HiFi			
Woofer	13,5 cm kevlar	13,5 cm kevlar	16,5 cm	16,5 cm kevlar
Tweeter	a cupola 2,5 cm orientabile dome 2.5 cm adjustable	3,2 cm orientabile / adjustable	a cupola 1,9 cm orientabile dome 1.9 cm adjustable	a cupola 3,2 cm orientabile dome 3.2 cm adjustable
Magnete tweeter / tweeter magnet	neodimio neodymium	neodimio neodymium	neodimio neodymium	neodimio neodymium
Membrana tweeter/ tweeter diaphragm	seta silk	seta silk	titanio titanium	seta silk
Potenza RMS / musicale RMS music power	50W/100W	---	60W/120W	---
Potenza nominale / peak Nominal power / peak	---	3,75/7,5/15W 30W peak, max 103dB	---	3,75/7,5/15W 30W peak, max 104dB
Amplificazione consigliata Recommended amplification	da 10 a 60W RMS from 10 to 60W RMS	---	da 10 a 70W RMS from 10 to 70W RMS	---
Impedenza / Tensione trasformatore Impedance / Transformer voltage	8Ω	100V	8Ω	100V
Risposta in frequenza / Sensibilità Frequency Response / Sensitivity	55-20000Hz/89dB	55-20000Hz/88dB	50-20000Hz/89dB	45-20000Hz/89dB
Angolo di dispersione / Dispersion angle	120° (V/O)	120° (V/O)	120° (V/O)	120° (V/O)
Dimensioni (LxHxP) / Size (WxHxD)	190x280x60 mm	190x280x75 mm	220x308x75 mm	220x308x85 mm
Foro da incasso (LxH) / Recessed hole (WxH)	160x245 mm	160x245 mm	185x273 mm	185x273 mm
Peso / Weight	1,6 kg	1,8 kg	1,8 kg	1,9 kg
Colore / Color	bianco / white RAL 9016		bianco / white RAL 9003	bianco / white RAL 9016
Cabinet	ABS V0 con griglia di protezione zincata verniciata / ABS V0 with painted galvanized grille			
Incasso su muratura / Recessed on masonry	SR1/SR1S (pag.181)		SR2 (pag.181)	SR2 (pag.181)
Incasso su cartongesso Recessed on plasterboard	non servono accessori, il diffusore nel retro è dotato di ganci per l'ancoraggio stabile no accessories needed, the speaker is provided with hook shaped anchors for stable fixing in the rear			



RECOMMENDED FOR	EAN13	CODE
	8051272182071	GIADA13F
	8051272182101	GIADA13F.R (min 10pz)
	8051272182149	GIADA13TF
	8051272182156	GIADA13TF.R (min 10pz)
	8051272188615	GIADA13AF
	8051272188622	GIADA13AF.R (min 10pz)
	8051272180138	GIADA213F
	8051272182460	GIADA213F.R (min 10pz)
8052015550706	RG13FB retina black per GIADA13F/TF/AF	



	GIADA13F	GIADA13TF	GIADA13AF	GIADA213F
Descrizione / Description	Diffusore rettangolare, 2 vie da incasso, HiFi, frameless Rectangular speaker, 2 way recessed, HiFi, frameless			Canale centrale per Home Cinema Central CH for Home Cinema
Woofer	13,5 cm kevlar	13,5 cm kevlar	13,5 cm kevlar	2x13,5cm kevlar
Tweeter orientabile / adjustable	a cupola 2,5 cm dome 2.5 cm	a cupola 2,5 cm dome 2.5 cm	a cupola 2,5 cm dome 2.5 cm	a cupola 2,5 cm dome 2.5 cm
Magnete tweeter / tweeter magnet	neodimio / neodymium	neodimio / neodymium	neodimio / neodymium	neodimio / neodymium
Membrana tweeter/ tweeter diaphragm	seta / silk	seta / silk	seta / silk	titanio / titanium
Potenza RMS / musicale RMS / Music Power	40W/80W	---	50W/100W	70W/140W
Potenza nominale / peak Nominal power / peak	---	3,75/7,5/15W 30W peak, max 104dB	---	---
Amplificazione consigliata Recommended amplification	da 10 a 50W RMS 10 to 50W RMS	---	---	da 10 a 80W RMS 10 to 80W RMS
Impedenza / Tensione trasformatore Impedance / Transformer voltage	8Ω	100V	attivo / active	8Ω
Risposta in frequenza / Sensibilità Frequency Response / Sensitivity	70-20000 Hz/90dB	70-20000 Hz/89dB	70-20000 Hz/90dB	65-20000 Hz/90dB
Angolo di dispersione / Dispersion angle	120° (V/O)	120° (V/O)	120° (V/O)	120° (V/O)
Alimentazione / Power supply	---	---	AL3B not included	---
Dimensioni (LxHxP) / Size (WxHxD)	175x267x75 mm	175x267x80 mm	175x267x85 mm	386x175x82 mm
Foro da incasso (LxH) / Recessed hole (WxH)	153x245 mm	153x245 mm	153x245 mm	364x153 mm
Peso / Weight	1,3 kg	1,4 kg	1,6 kg	2 kg
Colore / Color	bianco RAL 9016 white RAL 9016	bianco RAL 9016 white RAL 9016	bianco RAL 9016 white RAL 9016	bianco RAL 9016 white RAL 9016
Cabinet	ABS V0 con griglia di protezione zincata verniciata / ABS V0 with painted galvanized grille			
Incasso su muratura/ Recessed on masonry	SR1 (pag.181)	SR1 (pag.181)	SR1 (pag.181)	SC2 (pag.181)
Incasso su cartongesso Flush mounting plasterboard	non servono accessori, il diffusore nel retro è dotato di ganci per l'ancoraggio stabile no accessories needed, the speaker is provided with hook shaped anchors for stable fixing in the rear			













RECOMMENDED FOR	EAN13	CODE
	8051272182217	GIADA16F
	8051272182224	GIADA16F.R (min 10pz)
	8051272182309	GIADA16TF
	8051272182316	GIADA16TF.R (min 10pz)
	8051272187397	GIADA16AF
	8051272188585	GIADA16AF.R (min 10pz)
	8052015550508	RG16FB retina black RAL9004 per GIADA16F/TF/AF
	8051272182354	GIADA20F
	8051272182361	GIADA20F.R (min 10pz)
	8051272182439	GIADA20TF
	8051272182446	GIADA20TF.R (min 10pz)



	GIADA16F	GIADA16TF	GIADA16AF	GIADA20F	GIADA20TF
Descrizione / Description	Diffusore rettangolare, da incasso, 2 vie, HiFi, frameless / Rectangular speaker, recessed, 2 way, HiFi, frameless				
Woofer	16,5 cm kevlar	16,5 cm kevlar	16,5 cm kevlar	20,5 cm kevlar	20,5 cm kevlar
Tweeter orientabile / adjustable	a cupola 2,5 cm dome 2.5 cm	a cupola 2,5 cm dome 2.5 cm	a cupola 2,5 cm dome 2.5 cm	a cupola 3,2 cm dome 3,2 cm	a cupola 3,2 cm dome 3,2 cm
Magnete tweeter / tweeter magnet	neodimio / neodymium	neodimio / neodymium	neodimio / neodymium	neodimio / neodymium	neodimio / neodymium
Membrana tweeter/ tweeter diaphragm	seta / silk	seta / silk	seta / silk	seta / silk	seta / silk
Potenza RMS / musicale RMS / Music Power	60W/120W	---	50W/100W	80W/160W	---
Potenza nominale / peak Nominal power / peak	---	3,75/7,5/15W 30W peak, max 105dB	---	---	3,75/7,5/15W 30W peak, max 105dB
Amplificazione consigliata Recommended amplification	da 10 a 70W RMS 10 to 70W RMS	---	---	da 10 a 90W RMS 10 to 90W RMS	---
Impedenza / Tensione trasformatore Impedance / Transformer voltage	8Ω	100V	attivo / active	8Ω	100V
Risposta in frequenza / Sensibilità Frequency Response / Sensitivity	60-20000 Hz/90dB	60-20000 Hz/90dB	60-20000 Hz/90dB	50-20000 Hz/90dB	50-20000 Hz/90dB
Angolo di dispersione /Dispersion angle	120° (V/O)	120° (V/O)	120° (V/O)	120° (V/O)	120° (V/O)
Alimentazione / Power supply	---	---	AL3B not included	---	---
Dimensioni (LxHxP) / Size (WxHxD)	205x300x86 mm	205x300x90 mm	205x300x96 mm	242x362x105 mm	242x362x110 mm
Foro da incasso (LxH) Recessed hole (WxH)	186x280 mm	186x280 mm	186x280 mm	220x340 mm	220x340 mm
Peso / Weight	1,6 Kg	1,7 kg	1,8 kg	1,9 kg	2 kg
Colore / Color	bianco RAL 9016 white RAL 9016	bianco RAL 9016 white RAL 9016	bianco RAL 9016 white RAL 9016	bianco RAL 9016 white RAL 9016	bianco RAL 9016 white RAL 9016
Cabinet	ABS V0 con griglia di protezione zincata verniciata / ABS V0 with painted galvanized grille				
Incasso su muratura Recessed on masonry	SR2 (pag.181)	SR2 (pag.181)	SR2 (pag.181)	SR3PLUS (pag.181)	SR3PLUS (pag.181)
Incasso su cartongesso Flush mounting plasterboard	non servono accessori, il diffusore nel retro è dotato di ganci per l'ancoraggio stabile no accessories needed, the speaker is provided with hook shaped anchors for stable fixing in the rear				



RECOMMENDED FOR	EAN13	CODE
	8051272182231	GIADA16HP EOL
	 8051272182248	GIADA16HP.R (min 10pz) EOL
	8051272182255	GIADA16HPA EOL
	 8051272182262	GIADA16HPA.R (min 10pz) EOL
	8051272182477	GIADA213HP EOL
	IP44 8051272189698	GIADA213HP.IP EOL
	 8051272182484	GIADA213HP.R (min 10pz) EOL
	8051272188974	GIADA213HPF
	 8051272188981	GIADA213HPF.R (min 10pz)



	GIADA16HP	GIADA16HPA	GIADA213HP	GIADA213HPF frameless
Descrizione / Description	Diffusore rettangolare TOP CLASS da incasso HiFi rectangular speaker TOP CLASS recessed HiFi			
	2 vie / 2 way	2 vie / 2 way	3 vie / 3 way	3 vie / 3 way
Utilizzo negli Home Cinema	canale anteriore e posteriore front and rear channel	---	canale centrale, anteriore e posteriore centre, front and rear channel	canale centrale o diffusioni sonore di alta qualità. central speaker or high quality audio systems
Woofer	16,5 cm	16,5 cm	2x13 cm	2x13 cm
Tweeter	a cupola 2,5 cm orientabile dome 2.5 cm adjustable		2x2,5 cm orientabile 2x2.5 cm adjustable	2x2,5 cm orientabile 2x2.5 cm adjustable
Medio / Medium	---	---	8 cm	8 cm
Magnete tweeter / tweeter magnet	neodimio / neodymium	neodimio / neodymium	neodimio / neodymium	neodimio / neodymium
Membrana tweeter/ tweeter diaphragm	seta e titanio silk and titanium	seta e titanio silk and titanium	seta e titanio silk and titanium	seta e titanio silk and titanium
Potenza RMS / musicale RMS / Music Power	80W/160W	50W/100W	120W/240W	120W/240W
Amplificazione consigliata Recommended amplification	da 10 a 100W RMS 10 to 100W RMS	---	da 10 a 150W RMS 10 to 100W RMS	da 10 a 150W RMS 10 to 100W RMS
Impedenza / Tensione trasformatore Impedance / Transformer voltage	4-8Ω selezionabile 4-8Ω selectable	attivo classe D D class active	4-8Ω selezionabile 4-8Ω selectable	4-8Ω selezionabile 4-8Ω selectable
Risposta in frequenza / Sensibilità Frequency Response / Sensitivity	45-22000Hz / 88dB	45-22000Hz / 88dB	45-22000Hz / 91dB	45-22000Hz / 91dB
Alimentazione / Power supply	---	AL5B not included	---	---
Dimensioni (LxHxP) / Size (WxHxD)	219x306x90 mm	219x306x90 mm	357x255x84 mm	357x255x84 mm
Foro da incasso (LxH) / Recessed hole (WxH)	190x275 mm	190x275 mm	330x225 mm	330x225 mm
Peso / Weight	1,9 kg	2,2 kg	5 kg	5 kg
Colore / Color	bianco / white RAL 9016	bianco / white RAL 9016	bianco / white RAL 9016	bianco / white RAL 9016
Cabinet	ABS V0 con griglia di protezione zincata verniciata / ABS V0 with painted galvanized grille			
Incasso su muratura / Recessed on masonry	SR2 (pag.159)	SR2 (pag.159)	SR3/SR3PLUS (pag.159)	SR3/SR3PLUS (pag.159)
Incasso su cartongesso Recessed on plasterboard	non servono accessori, il diffusore nel retro è dotato di ganci per l'ancoraggio stabile no accessories needed, the speaker is provided with hook shaped anchors for stable fixing in the rear			
Incasso a filo muro Recessed in the wall	SR2FM (pag.183)	SR2FM (pag.183)	SR3FM (pag.183)	---
Incasso a filo cartongesso Flush mounting plasterboard	SR2FC (pag.183)	SR2FC (pag.183)	SR3FC (pag.183)	---



RECOMMENDED FOR

EAN13

CODE



	8051272188349	GIADA16HPF
	8051272188356	GIADA16HPF.R (min 10pz)
	8051272188370	GIADA16HPFA
	8051272188387	GIADA16HPFA.R (min 10pz)
	8051272187373	GIADA20AF
	8051272188592	GIADA20AF.R (min 10pz)
	8051272188936	GIADA20HPF
	8051272188943	GIADA20HPF.R (min 10pz)
	8051272188950	GIADA20HPFA
	8051272188967	GIADA20HPFA.R (min 10pz)



	GIADA16HPF	GIADA16HPFA	GIADA20AF	GIADA20HPF	GIADA20HPFA
Descrizione / Description	Diffusore rettangolare TOP class da incasso, HiFi, frameless / TOP class Recessed Rectangular speaker, HiFi, frameless				
	2 vie / 2 way	2 vie / 2 way	2 vie / 2 way	3 vie / 3 way	3 vie / 3 way
Woofer	16,5 cm	16,5 cm	20,5 cm kevlar	20 cm	20 cm
Tweeter orientabile / adjustable	a cupola 2,5 cm dome 2,5 cm	a cupola 2,5 cm dome 2,5 cm	a cupola 3,2 cm dome 3,2 cm	a cupola 2,5 cm dome 2,5 cm	a cupola 2,5 cm dome 2,5 cm
Medio	---	---	---	8cm kevlar	8cm kevlar
Magnete tweeter / tweeter magnet	neodimio / neodymium	neodimio / neodymium	neodimio / neodymium	neodimio / neodymium	neodimio / neodymium
Membrana tweeter tweeter diaphragm	seta e titanio silk and titanium	seta e titanio silk and titanium	seta / silk	seta e titanio silk and titanium	seta e titanio silk and titanium
Potenza RMS / musicale RMS / Music Power	80W/160W	50W/100W	50W/100W	120W/240W	50W/100W
Amplificazione consigliata Recommended amplification	da 10 a 100W RMS	---	---	da 10 a 150W RMS 10 to 150W RMS	---
Impedenza / Tensione trasformatore Impedance / Transformer voltage	4-8 Ω selezionabile 4-8 Ω selectable	attivo / active	attivo / active	4-8 Ω selezionabile 4-8 Ω selectable	attivo / active
Risposta in frequenza / Sensibilità Frequency Response / Sensitivity	45-22000Hz/88dB	45-22000Hz/109dB	50-20000Hz/90dB	40-22000Hz/89dB	40-22000Hz/110dB
Angolo di dispersione Dispersion angle	120° (V/O)	120° (V/O)	120° (V/O)	120° (V/O)	120° (V/O)
Alimentazione / Power supply	---	AL3B not included	AL3B not included	---	AL3B not included
Dimensioni (LxHxD) / Size (WxHxD)	219x306x96 mm	219x306x96 mm	242x362x125 mm	264x367x112 mm	264x367x112 mm
Foro da incasso (LxH) Recessed hole (WxH)	190x275 mm	190x275 mm	220x340 mm	325x222 mm	325x222 mm
Peso / Weight	2,1 kg	2,4 kg	2,2 kg	3,1 kg	3,4 kg
Colore / Color	bianco RAL 9016 white RAL 9016	bianco RAL 9016 white RAL 9016	bianco RAL 9016 white RAL 9016	bianco RAL 9016 white RAL 9016	bianco RAL 9016 white RAL 9016
Cabinet	ABS V0 con griglia di protezione zincata verniciata / ABS V0 with painted galvanized grille				
Incasso su muratura Recessed on masonry	SR2 (pag.181)	SR2 (pag.181)	SR3PLUS (pag.181)	SR3PLUS (pag.181)	SR3PLUS (pag.181)
Incasso su cartongesso Flush mounting plasterboard	non servono accessori, il diffusore nel retro è dotato di ganci per l'ancoraggio stabile no accessories needed, the speaker is provided with hook shaped anchors for stable fixing in the rear				



RECOMMENDED FOR



EAN13

CODE



8051272189575

GIADA20SPF



8051272189582

GIADA20SPF.R (min 10pz)

121dB



GIADA20SPF

Descrizione / Description	Diffusore rettangolare, 2 vie da incasso, SUPER POWER, HiFi, frameless Rectangular speaker, 2 way, SUPER POWER, recessed, HiFi, frameless
Altoparlante / Speaker	Coax
Magnete / Magnet	neodimio / neodymium
Cestello / Small basket	alluminio / aluminium
Woofer	20,5 cm
Driver	a compressione da 3,4 cm in titanio / 3.4 cm titanium compression
Potenza RMS / musicale RMS / Music Power	200W / 400W
Amplificazione consigliata Recommended amplification	da 150 a 300W RMS 150 to 300W RMS
Impedenza / Tensione trasformatore Impedance / Transformer voltage	8Ω
Risposta in frequenza / Sensibilità Frequency Response / Sensitivity	70-20000 Hz / 97 dB
Angolo di dispersione / Dispersion angle	100° (V/O)
Modalità di funzionamento Operation mode	- FULL RANGE risposta in frequenza 70-20000 Hz - Sensibilità 97dB - SAT risposta in frequenza 140-20000 Hz - Sensibilità 97dB - FULL RANGE frequency response 70-20000 Hz - Sensitivity 97dB - SAT frequency response 140-20000 Hz - Sensitivity 97dB
Dimensioni (LxHxP) / Size (WxHxD)	242x362x135 mm
Foro da incasso (LxH) / Recessed hole (LxH)	220x340 mm
Peso / Weight	2,9 kg
Colori / Color	bianco RAL 9016 / white RAL 9016
Cabinet	ABS V0 con griglia di protezione zincata verniciata / ABS V0 with painted galvanized grille
Incasso su muratura / Recessed on masonry	SR3PLUS (pag.181)
Incasso su cartongesso Recessed on plasterboard	non servono accessori, il diffusore nel retro è dotato di ganci per l'ancoraggio stabile no accessories needed, the speaker is provided with hook shaped anchors for stable fixing in the rear
Subwoofer consigliato Recommended subwoofer	- per utilizzi Pub SUB15A / -for Pub SUB15A use - per sistemi Home Cinema SMARTQUBEB / for SMARTQUBEB Home Cinema systems





RECOMMENDED FOR



EAN13

CODE

8051272185485	PERLA13P
 8051272185492	PERLA13P.R (min 10pz)
8051272185508	PERLA13TP
 8051272185515	PERLA13TP.R (min 10pz)



	PERLA13P	PERLA13TP
Descrizione / Description	Diffusore rettangolare, 2 vie da incasso, HiFi / Rectangular speaker, 2 way recessed, HiFi	
Woofer	13,5 cm	13,5 cm
Tweeter orientabile / adjustable	a cupola 2,5 cm / dome 2.5 cm	a cupola 2,5 cm / dome 2.5 cm
Magnete tweeter / tweeter magnet	neodimio / neodymium	neodimio / neodymium
Membrana tweeter/ tweeter diaphragm	titanio / titanium	titanio / titanium
Potenza RMS / musicale RMS / Music Power	50W/100W	---
Potenza nominale / peak Nominal power / peak	---	3,75/7,5/15W 30W peak, max 106dB
Amplificazione consigliata Recommended amplification	da 10 a 60W RMS 10 to 60W RMS	---
Impedenza / Tensione trasformatore Impedance / Transformer voltage	8Ω	100V
Risposta in frequenza / Sensibilità Frequency Response / Sensitivity	55-20000 Hz/89dB	60-20000 Hz/91dB. max 1mt 102dB.
Angolo di dispersione Dispersion angle	120° (V/O)	120° (V/O)
Dimensioni (LxHxD) / Size (WxHxD)	236x306x53 mm	236x306x53 mm
Foro da incasso (LxH) Recessed hole (LxH)	170x250 mm	170x250 mm
Peso / Weight	1,8 kg	1,9 kg
Colore / Color	bianco RAL 9016 / white RAL9016	bianco RAL 9016 / white RAL9016
Cabinet	MDF verniciato, griglia in acciaio verniciato / Painted MDF, Painted Steel Grille	
Incasso su tramezze o pareti sottili Recessed on partitions or thin walls	SR1S (pag.181)/CF2	SR1S (pag.181)/CF2
Incasso su muratura Recessed on masonry	SR1 (pag.181)/CF2	SR1 (pag.181)/CF2
Incasso su cartongesso Recessed on plasterboard	non servono accessori, il diffusore nel retro è dotato di ganci per l'ancoraggio stabile no accessories needed, the speaker is provided with hook shaped anchors for stable fixing in the rear	



RECOMMENDED FOR	EAN13	CODE
	8051272183306	ROUND5T (min 12pz)
	8051272187007	ROUND5TB nero / black (min 12pz)
	8051272183313	ROUND6T (min 12pz)
	8051272180152	ROUND12
	8051272188141	ROUND12B nero / black
	8051272183047	ROUND12.R (min 10pz)
	8051272183054	ROUND12T
	8051272187014	ROUND12TB nero / black
	8051272183061	ROUND12T.R (min 10pz)



	ROUND5T	ROUND6T	ROUND12	ROUND12T
	Diffusore rotondo, da incasso / Round speaker, recessed			
Descrizione / Description	---	---	2 vie, HiFi / 2 way, HiFi	2 vie, HiFi / 2 way, HiFi
Woofer	altoparlante a gamma larga da 11 cm 11 cm wide range	altoparlante a gamma larga da 15,5 cm 15.5 cm wide range	10 cm	10 cm
Tweeter	---	---	1,3 cm	1,3 cm
Membrana / Diaphragm	---	---	mylar	mylar
Potenza RMS / musicale RMS music power	---	---	25W/50W	---
Potenza nominale / peak Nominal power / peak	3/6W 12W peak, max 103dB	3/6W 12W peak, max 104dB	---	1,5/3/6W 12W peak, max 97dB
Amplificazione consigliata Recommended amplification	---	---	10 a 40 W RMS 10 to 40W RMS	---
Impedenza / Tensione trasformatore Impedance / Transformer voltage	100V	100V	8Ω	100V
Risposta in frequenza / Sensibilità Frequency Response / Sensitivity	100-15000Hz 92dB ± 3dB	100-16000Hz 93dB± 3dB	70-20000Hz/86dB	70-20000Hz/86dB
Angolo di dispersione / Dispersion angle	120° (V/O)	120° (V/O)	120° (V/O)	120° (V/O)
Dimensioni (DxP) / Size (DxD)	175x60 mm	188x76 mm	167x60 mm	167x60 mm
Foro da incasso (D) / Recessed hole (D)	150 mm	170 mm	140 mm	140 mm
Peso / Weight	0,5 kg	0,7 kg	0,7 kg	0,8 kg
Colore / Color	bianco / white RAL9016 nero / black RAL9005	bianco / white RAL9016	bianco / white RAL9003 nero / black RAL9011	bianco / white RAL9003 nero / black RAL9011
Cabinet	ABS, griglia in metallo ABS, metal grille	ABS, griglia in metallo ABS, metal grille	ABS, griglia in metallo ABS, metal grille	ABS, griglia in metallo ABS, metal grille
Incasso su muratura / Recessed on masonry	---	---	non adatto / not suitable	
Incasso su cartongesso Recessed on plasterboard	non servono accessori, il diffusore nel retro è dotato di ganci per l'ancoraggio stabile no accessories needed, the speaker is provided with hook shaped anchors for stable fixing in the rear			
Confezione / Packaging	ordinabile in multipli di 12pz can be ordered in multiples of 12pcs		---	



RECOMMENDED FOR	EAN13	CODE
	IP33C EN54-24	8051272180589
	EN54-24	8051272180787
	EN54-24	8051272180565
		ROUND10EN
		CB1 connetting box
		ROUND13EN



	ROUND10EN	ROUND13EN
	Diffusore rotondo, da incasso / Round speaker, recessed	
Descrizione / Description	fornito con calotta antifiamma e connetting block (morsetto ceramico + fusibile termico) included with flame retardant shell and connetting block (ceramic clamp and thermal fuse)	fornito con fondello antifiamma in acciaio completo di kit tagliafuoco included with flame retardant steel back complete with fireproof kit
Grado di protezione / Protection degree	IP33C	IP21
Certificato EN54 / EN54 Certificate	si / yes	si / yes
Woofer	bicorno da 10 cm / 10 cm bicycle	bicorno da 13 cm / 13 cm bicycle
Potenza nominale/peak Nominal power/peak	3/6W 12W peak, max 102dB	3/6W 12W peak, max 106dB
Impedenza / Tensione trasformatore Impedance / Transformer voltage	100V	100V
Risposta in frequenza / Sensibilità Frequency Response / Sensitivity	120-18000Hz-10dB/90dB	110-18000Hz-10dB/95dB
Angolo di dispersione / Dispersion angle	---	155°(V/O) 2KHz
Dimensioni (DxP) / Size (DxD)	142x150 mm	185x137 mm
Foro da incasso (D) / Recessed hole (D)	125 mm	160 mm
Peso / Weight	0,9 kg	1,4 kg
Colore / Color	bianco / white RAL9016	bianco / white RAL9016 rosso / red RAL3000
Cabinet	ABS V0 con griglia di protezione ABS V0 with protection grille	ABS V0 con griglia di protezione zincata verniciata ABS V0 with painted galvanized grille
Incasso su muratura Recessed on masonry	non adatto / not suitable	non adatto / not suitable
Incasso su cartongesso / Recessed on plasterboard	non servono accessori, il diffusore nel retro è dotato di ganci per l'ancoraggio stabile no accessories needed, the speaker is provided with hook shaped anchors for stable fixing in the rear	



diffusori da incasso certificati EN54
built-in speakers EN54 certificate

VIVALDI

RECOMMENDED FOR	EAN13	CODE
	EN54-24	8051272189384 ROUND16AB
	EN54-24	8051272180572 ROUND16EN

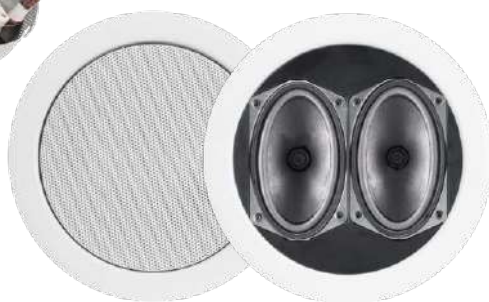

	ROUND16AB	ROUND16EN
Descrizione / Description	Diffusore rotondo AB da incasso a soffitto, IP21, fornito con fondello antifiama in acciaio. Integra due sistemi di altoparlanti indipendenti ellittici da 6W ognuno. Da utilizzare in zone con un solo altoparlante in cui è richiesta la ridondanza AB round recessed ceiling speaker, IP21, included with flame retardant steel caseback. It integrates two independent elliptical speaker systems of 6W each. For use in single-speaker areas where redundancy is required	Diffusore rotondo da incasso a soffitto, IP21, fornito con fondello antifiama in acciaio completo di kit tagliafuoco. Struttura in acciaio con griglia di protezione. Morsettiere di collegamento in materiale ceramico per i conduttori antifiama, vite di messa a terra, cablaggio interno realizzato con conduttori antifiama Round recessed ceiling speaker, IP21, included with flame retardant steel back complete with fireproof kit. Steel structure with protection grid. Ceramic connection terminal blocks for flame retardant conductors, grounding screw, internal wiring made with flame retardant conductors
Info aggiuntive / Additional info	2x morsettiere di collegamento in materiale ceramico per i conduttori antifiama 2x fusibile termico 2x vite di messa a terra Doppio cablaggio interno realizzato con conduttori antifiama 2x trasformatori a 100V 2x ceramic connection terminal block for flame retardant conductors 2x thermal fuse 2x grounding screw Double internal wiring made with flame retardant conductors 2x 100V transformers	---
Certificato EN54 / EN54 Certificate	si / yes	si / yes
Altoparlante / Speaker	2x ellittico 11,5x6,5 cm / 2x elliptical 11,5x6,5 cm	bicono da 16 cm / 16 cm dual cone
Potenza nominale / peak Nominal power	2x0,75/1,5/3/6W 2x12W peak, max 106dB	5/10W 20W peak, max 110dB
Impedenza / Tensione trasformatore Impedance / Transformer voltage	100V	100V
Risposta in frequenza Frequency response	120-18500Hz - 10dB	80-18000Hz - 10dB
Sensibilità / Sensibility	95 dB 1+1W	97dB
Max output level / full power	103dB	107dB
Dimensioni (DxP) / Size (DxD)	241x100 mm	230x142 mm
Foro da incasso (D) / Recessed hole (D)	218 mm	210 mm
Peso / Weight	1,8 kg	1,8 kg
Colore / Color	bianco / white RAL9010	bianco / white RAL9016 calotta rosso / red shell RAL3000
Cabinet	acciaio con griglia di protezione zincata verniciata / steel with painted galvanized grille	
Incasso su muratura Recessed on masonry	non adatto / not suitable	
Incasso su cartongesso Recessed on drywall	non servono accessori, il diffusore nel retro è dotato di ganci per l'ancoraggio stabile no accessories needed, the speaker is provided with hook shaped anchors for stable fixing in the rear	



RECOMMENDED FOR	EAN13	CODE
	8051272180046	ROUND13L
	8051272183092	ROUND13L.R (min 10pz)
	8051272180053	ROUND13TL
	8051272183115	ROUND13TL.R (min 10pz)
	8051272180060	ROUND16L
	IP44 8051272189681	ROUND16L.IP
	8051272183160	ROUND16L.R (min 10pz)
	8051272180077	ROUND16TL
	8051272183207	ROUND16TL.R (min 10pz)

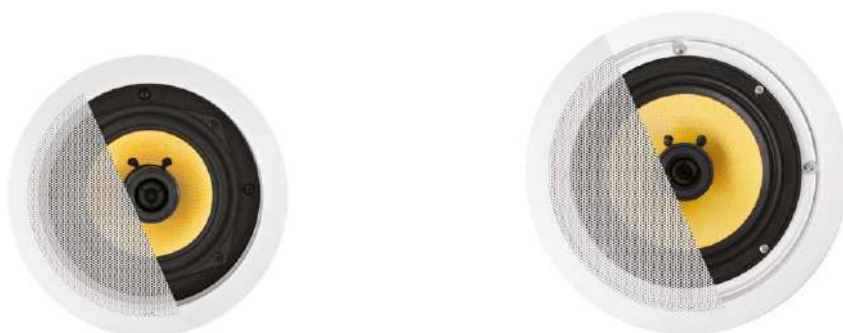

	ROUND13L	ROUND13TL	ROUND16L	ROUND16TL
	Diffusore rotondo, da incasso / Round speaker, recessed			
Descrizione / Description	2 vie/2 way, HiFi	2 vie/2 way, HiFi	2 vie/2 way, HiFi	2 vie/2 way, HiFi
Woofer	13,5 cm kevlar	13,5 cm kevlar	16,5 cm kevlar	16,5 cm kevlar
Tweeter orientabile / adjustable	2,5 cm	2,5 cm	2,5 cm	2,5 cm
Membrana / Diaphragm	seta / silk	seta / silk	seta / silk	seta / silk
Potenza RMS / musicale RMS / Music Power	50W/100W	---	60W/120W	---
Potenza nominale/peak Nominal power/peak	---	2,5/5/10W 20W peak, max 102dB	---	2,5/5/10W 20W peak, max 102dB
Amplificazione consigliata Recommended amplification	da 10 a 60W RMS 10 to 60W RMS	---	10 a 70W RMS 10 to 70W RMS	---
Impedenza / Tensione trasformatore Impedance / Transformer voltage	8Ω	100V	8Ω	100V
Risposta in frequenza / Sensibilità Frequency Response / Sensitivity	55-20000Hz/88 dB	55-20000Hz/89 dB	50-20000Hz/89dB	50-20000Hz/89dB
Angolo di dispersione / Dispersion angle	120° (V/O)	120° (V/O)	120° (V/O)	120° (V/O)
Dimensioni (DxP) / Size (DxD)	203x75 mm	203x75 mm	235x88 mm	235x88 mm
Foro da incasso (D) / Recessed hole (D)	165 mm	165 mm	195 mm	195 mm
Peso / Weight	1,2 kg	1,3 kg	1,4 kg	1,5 kg
Colore / Color	bianco / white RAL9016	bianco / white RAL9016	bianco / white RAL9016	bianco / white RAL9016
Cabinet	ABS V0 con griglia di protezione zincata verniciata / ABS V0 with painted galvanized grille			
Incasso su muratura Recessed on masonry	SR13 (pag.182)	SR13 (pag.182)	SR16 (pag.182)	SR16 (pag.182)
Incasso su cartongesso / Recessed on plasterboard	non servono accessori, il diffusore nel retro è dotato di ganci per l'ancoraggio stabile no accessories needed, the speaker is provided with hook shaped anchors for stable fixing in the rear			



RECOMMENDED FOR	EAN13	CODE
	8051272181104	ROUND7F
	8051272183337	ROUND7F.R (min 10pz)
	8051272183344	ROUND7TF
	8051272183351	ROUND7TF.R (min 10pz)
	8052015551024	RR7FB retina black per ROUND7F/TF
	8051272187069	ROUND13F
	8051272188424	ROUND13F.R (min 10pz)
EN54-24	8051272187021	ROUND13TF
EN54-24	8051272187700	ROUND13TF.R (min 10pz)
	8052015550751	RR13FB retina black per ROUND13F/TF
	8052015550768	RR13F retina per ROUND13F/TF



	ROUND7F	ROUND7TF	ROUND13F	ROUND13TF
Descrizione / Description	Diffusore rotondo 2 vie, da incasso, HiFi, frameless / Round speaker 2 way recessed, HiFi, frameless			
Certificato EN54 / EN54 Certificate	---	---	---	si, se installato con copertura antifiama/ antincendio SQR13 (pag. 182 da ordinare a parte) yes, if installed with flame retardant/fire cover SQR13 pag182 (not included)
Woofers	7,5 cm kevlar	7,5 cm kevlar	13,5 cm	13,5 cm
Tweeter orientabile / adjustable	a cupola 1,3 cm dome 1.3 cm	a cupola 1,3 cm dome 1.3 cm	a cupola 1,3 cm dome 1.3 cm	a cupola 1,3 cm dome 1.3 cm
Magnete / Magnet	neodimio / neodymium	neodimio / neodymium	neodimio / neodymium	neodimio / neodymium
Membrana / Diaphragm	titanio / titanium	titanio / titanium	mylar	mylar
Potenza RMS / musicale RMS / Music Power	20W/40W	---	50W/100W	---
Potenza nominale / peak Nominal power / peak	---	3/6W 12W peak, max 101dB	---	2,5/5/10/15W 30W peak, max 102dB
Amplificazione consigliata Recommended amplification	da 10 a 30W RMS 10 to 30W RMS	---	da 10 a 110W RMS 10 to 110W RMS	---
Impedenza / Tensione trasformatore Impedance / Transformer voltage	8Ω	100V	8Ω	100V
Risposta in frequenza / Sensibilità Frequency Response / Sensitivity	130-20000Hz +3dB/90dB	130-20000Hz +3dB/90dB	70-20000Hz/87dB	70-20000Hz/87dB
Angolo di dispersione / Dispersion angle	120° (V/O)	120° (V/O)	120° (V/O)	120° (V/O)
Dimensioni (DxP) / Size (DxD)	116x58 mm	116x90 mm	204x77 mm	204x90 mm
Foro da incasso (D) / Recessed hole (D)	100 mm	100 mm	177 mm	177 mm
Peso / Weight	0,4 kg	0,8 kg	1,2 kg	1,3 kg
Colore / Color	bianco / white RAL9016	bianco / white RAL9016	bianco / white RAL9016	bianco / white RAL9016
Cabinet	ABS V0 con griglia di protezione zincata verniciata / ABS V0 with painted galvanized grille			
Incasso su muratura / Recessed on masonry	non adatto / not suitable	non adatto / not suitable	SR13 (pag.182)	SR13 (pag.182)
Incasso su cartongesso Recessed on plasterboard	non servono accessori, il diffusore nel retro è dotato di ganci per l'ancoraggio stabile no accessories needed, the speaker is provided with hook shaped anchors for stable fixing in the rear			



RECOMMENDED FOR	EAN13	CODE
	8051272180084	ROUND16F
	8051272183146	ROUND16F.R (min 10pz)
	8051272183177	ROUND16TF
	8051272183184	ROUND16TF.R (min 10pz)
	8051272187380	ROUND16AF
	8051272188653	ROUND16AF.R (min 10pz)
	8052015550492	RR16FB retina black RAL9004 per ROUND16F/TF/AF
	EN54-24 8051272180145	ROUND17TF
	EN54-24 8051272188608	ROUND17TF.R (min 10pz)



	ROUND16F	ROUND16TF	ROUND16AF	ROUND17TF
Descrizione / Description	Diffusore rotondo 2 vie, da incasso, HiFi, frameless / 2 way round speaker, recessed, HiFi, frameless			
	---			fornito con fondello antifiama IP33 included with flame retardant chamois IP33
Certificato EN54	---	---	---	si / yes
Woofer	16,5 cm kevlar	16,5 cm kevlar	16,5 cm kevlar	16,5 cm
Tweeter orientabile / adjustable	a cupola 1,9 cm dome 1.9 cm	a cupola 1,9 cm dome 1.9 cm	a cupola 1,9 cm dome 1.9 cm	a cupola 1,9 cm dome 1.9 cm
Magnete / Magnet	neodimio / neodymium	neodimio / neodymium	neodimio / neodymium	neodimio / neodymium
Membrana / Diaphragm	seta / silk	seta / silk	seta / silk	mylar
Potenza RMS / musicale RMS / Music Power	60W/120W	---	50W/100W	---
Potenza nominale / peak Nominal power / peak	---	3,75/7,5/15W 30W peak, max 104dB	---	2/4/8/16/32W 64W peak, max 104dB
Amplificazione consigliata Recommended amplification	da 10 a 70W RMS 10 to 70W RMS	---	---	---
Impedenza / Tensione trasformatore Impedance / Transformer voltage	8Ω	100V	attivo / active	100V
Risposta in frequenza / Sensibilità Frequency Response / Sensitivity	60-20000Hz / 90dB	60-20000Hz / 89dB	60-20000Hz / 90dB	65-20000Hz -10dB / 86dB
Angolo di dispersione Dispersion angle	120° (V/O)	120° (V/O)	120° (V/O)	---
Alimentazione / Power supply	---	---	AL3B not included	---
Dimensioni (DxP) / Size (DxD)	227x87 mm	227x87 mm	227x97 mm	284x155 mm
Foro da incasso (D) Recessed hole (D)	205 mm	205 mm	205 mm	262 mm
Peso / Weight	1,5 kg	1,5 kg	1,7 kg	2,9 kg
Colore / Color	bianco RAL9016 white RAL9016	bianco RAL9016 white RAL9016	bianco RAL9016 white RAL9016	bianco RAL9016 white RAL9016
Cabinet	ABS V0 con griglia di protezione zincata verniciata / ABS V0 with painted galvanized grille			
Incasso su muratura Recessed on masonry	SR16 (pag.182)	SR16 (pag.182)	non adatto / not suitable	non adatto / not suitable
Incasso su cartongesso Recessed on plasterboard	non servono accessori, il diffusore nel retro è dotato di ganci per l'ancoraggio stabile no accessories needed, the speaker is provided with hook shaped anchors for stable fixing in the rear			



RECOMMENDED FOR	EAN13	CODE
	8051272181111	ROUND20F
	8051272183238	ROUND20F.R (min 10pz)
EN54-24	8051272181128	ROUND20TF
EN54-24	8051272188431	ROUND20TF.R (min 10pz)
	8051272188660	ROUND20AF
	8051272188677	ROUND20AF.R (min 10pz)



	ROUND20F	ROUND20TF	ROUND20AF
Descrizione / Description	Diffusore rotondo, 2 vie da incasso, HiFi, frameless / Round speaker, 2 way recessed, HiFi, frameless		
Certificato EN54 EN54 Certificate	---	si, se installato con copertura antifiamma/antincendio SQR20 (da ordinare a parte) yes, if installed with flame retardant cover fire extinguishing SQR20 (not included)	---
Woofer	20,5 cm kevlar	20,5 cm kevlar	20,5 cm kevlar
Tweeter orientabile / adjustable	a cupola 1,9 cm / dome 1.9 cm	a cupola 1,9 cm / dome 1.9 cm	a cupola 1,9 cm / dome 1.9 cm
Magnete / Magnet	neodimio / neodymium	neodimio / neodymium	neodimio / neodymium
Membrana / Diaphragm	seta / silk	seta / silk	seta / silk
Potenza RMS / musicale RMS / Music Power	80W/160W	---	50W/100W
Potenza nominale / peak Nominal power / peak	---	2/4/8/16/32W 64W peak, max 108dB	---
Amplificazione consigliata Recommended amplification	da 10 a 90W RMS 10 to 90W RMS	---	---
Impedenza / Tensione trasformatore Impedance / Transformer voltage	8Ω	100V	attivo / active
Risposta in frequenza / Sensibilità Frequency Response / Sensitivity	50-20000Hz/90dB	50-20000Hz +-3dB/89dB	50-20000Hz/90dB
Angolo di dispersione / Dispersion angle	120° (V/O)	120° (V/O)	120° (V/O)
Alimentazione / Power supply	---	---	AL3B not included
Dimensioni (DxP) / Size (DxD)	277x105 mm	283x109 mm	277x125mm
Foro da incasso (D) / Recessed hole (D)	258 mm	258 mm	258 mm
Peso / Weight	2,0 kg	2,0 kg	2,3 kg
Colore / Color	bianco RAL9016 / white RAL9016	bianco RAL9016 / white RAL9016	bianco RAL9016 / white RAL9016
Cabinet	ABS V0 con griglia di protezione zincata verniciata / ABS V0 with painted galvanized grille		
Incasso su muratura / Recessed on masonry	non adatto / not suitable	SQR20 (pag.183)	non adatto / not suitable
Incasso su cartongesso Recessed on plasterboard	non servono accessori, il diffusore nel retro è dotato di ganci per l'ancoraggio stabile no accessories needed, the speaker is provided with hook shaped anchors for stable fixing in the rear		



RECOMMENDED FOR

EAN13

CODE



8051272189551

ROUND20HPF

8051272189568

ROUND20HPF.R (min 10pz)



ROUND20HPF frameless

Descrizione / Description	Diffusore TOP CLASS, rotondo, 3 vie da incasso a controsoffitto, HiFi TOP CLASS speaker, round, 3 way recessed false ceiling, HiFi
Woofer	20 cm
Tweeter orientabile / adjustable	a cupola 2,5 cm / dome 2.5 cm
Medio	8 cm
Magnete / Magnet	neodimio / neodymium
Membrana / Diaphragm	seta e titanio / silk and titanium
Potenza RMS / musicale RMS / Music Power	120W/240W
Amplificazione consigliata Recommended amplification	da 10 a 150W RMS 10 to 150W RMS
Impedenza / Tensione trasformatore Impedance / Transformer voltage	4-8Ω selezionabile 4-8Ω selectable
Risposta in frequenza / Sensibilità Frequency Response / Sensitivity	40-22000Hz / 89dB
Angolo di dispersione / Dispersion angle	120° (V/O)
Alimentazione / Power supply	---
Dimensioni (DxP) / Size (DxD)	273x127 mm
Foro da incasso (D) / Recessed hole (D)	250 mm
Peso / Weight	3 kg
Colore / Color	bianco RAL9016 / white RAL9016
Cabinet	ABS V0 con griglia di protezione zincata verniciata / ABS V0 with painted galvanized grille
Incasso su muratura / Recessed on masonry	non adatto / not suitable
Incasso su cartongesso Recessed on plasterboard	non servono accessori, il diffusore nel retro è dotato di ganci per l'ancoraggio stabile no accessories needed, the speaker is provided with hook shaped anchors for stable fixing in the rear



RECOMMENDED FOR	EAN13	CODE
	8051272189599	ROUND20SPF
	8051272189605	ROUND20SPF.R (min 10pz)



121dB

ROUND20SPF

Descrizione / Description	Diffusore rotondo, 2 vie da incasso, SUPER POWER, HiFi, frameless Round speaker, 2 way recessed, SUPER POWER, HiFi, frameless
Altoparlante / Speaker	Coax
Magnete / Magnet	neodimio / neodymium
Cestello / Drum	alluminio / aluminium
Woofer	20,5 cm
Driver	a compressione da 3,4 cm in titanio / 3.4 cm titanium compression
Potenza RMS / musicale RMS / Music Power	200W / 400W
Amplificazione consigliata Recommended amplification	da 150 a 300W RMS / 150 to 300W RMS
Impedenza / Tensione trasformatore Impedance / Transformer voltage	8Ω
Risposta in frequenza / Sensibilità Frequency Response / Sensitivity	70-20000Hz / 97 dB
Angolo di dispersione / Dispersion angle	100° (V/O)
Modalità di funzionamento Operation mode	- FULL RANGE risposta in frequenza 70-20000Hz - Sensibilità 97dB - SAT risposta in frequenza 140-20000Hz - Sensibilità 97dB - FULL RANGE frequency response 70-20000Hz - Sensitivity 97dB - SAT frequency response 140-20000Hz - Sensitivity 97dB
Dimensioni (DxP) / Size (DxD)	284x135 mm
Foro da incasso (D) / Recessed hole (D)	258 mm
Peso / Weight	2,8 kg
Colore / Color	bianco RAL 9016 / white RAL9016
Cabinet	ABS V0 con griglia di protezione zincata verniciata / ABS V0 with painted galvanized grille
Incasso su muratura Recessed on masonry	non adatto / not suitable
Incasso su cartongesso Recessed on plasterboard	non servono accessori, il diffusore nel retro è dotato di ganci per l'ancoraggio stabile no accessories needed, the speaker is provided with hook shaped anchors for stable fixing in the rear
Subwoofer consigliato	- per utilizzi Pub SUB15A e per sistemi Home Cinema SMARTQUBE - for Pub use SUB15A / for Home Cinema systems SMARTQUBE



Retine personalizzate per arredare con semplicità

Customised grills for simple decoration



EAN13

CODE

8052015550911

OPERA



Codice / Code	OPERA
Modelli diffusori realizzabili Feasible speaker models	ROUND16 - ROUND20 GIADA16 - GIADA20 - GIADA213
Tipo di file File type	Tiff - JPEG - PNG
Risoluzione consigliata Recommended resolution	300 dpi
Quantità minimo ordinabile Moq	1pz
Elaborazione grafica Graphic design	design@vivaldigroup.it



RECOMMENDED FOR

EAN13

CODE



IP56	8051272183467	MARINE6
IP56	8051272183474	MARINE6T
IP56	8051272183481	MARINE7
IP56	8051272183498	MARINE7T



MARINE6



MARINE7T

	MARINE6	MARINE6T	MARINE7	MARINE7T
Descrizione / Description	Diffusore rotondo, 2 vie da incasso, HiFi resistente al cloro e alla salsedine Round speaker, 2 way built-in, HiFi resistant to chlorine and salt			
Grado di protezione / Protection degree	IP56	IP56	IP56	IP56
Woofers	13 cm	13 cm	16 cm	16 cm
Tweeter	1,8 cm	1,8 cm	2 cm	2 cm
Potenza RMS / musicale RMS / Music Power	20W/35W	---	25W/45W	---
Potenza nominale / peak Nominal power / peak	---	3,75/7,5/15W 30W peak, max 105dB	---	3,75/7,5/15W 30W peak, max 105dB
Amplificazione consigliata Recommended amplification	da 10 a 30W RMS 10 to 30W RMS	---	da 10 a 35W RMS 10 to 35W RMS	---
Impedenza / Tensione trasformatore Impedance / Transformer voltage	8Ω	100V	8Ω	100V
Risposta in frequenza / Sensibilità Frequency Response / Sensitivity	95-20000Hz/90dB	95-20000Hz/90dB	85-20000Hz/90dB	85-20000Hz/90dB
Angolo di dispersione / Dispersion angle	120° (V/O)	120° (V/O)	120° (V/O)	120° (V/O)
Dimensioni (DxP) / Size (DxD)	165x75 mm	165x75 mm	190x90 mm	190x90 mm
Foro da incasso (D) / Recessed hole (D)	122 mm	122 mm	147 mm	147 mm
Peso / Weight	0,7 kg	0,7 kg	0,8 kg	0,8 kg
Colore / Color	bianco RAL9016 white RAL9016	bianco RAL9016 white RAL9016	bianco RAL9016 white RAL9016	bianco RAL9016 white RAL9016
Cabinet	ABS V0	ABS V0	ABS V0	ABS V0
Incasso su muratura Recessed on masonry	non adatto / not suitable	non adatto / not suitable	non adatto / not suitable	non adatto / not suitable
Incasso su cartongesso Recessed on plasterboard	non servono accessori / no accessories needed			



diffusori da parete HiFi slim serie PLANA (4 cm)
wall speakers HiFi slim PLANA series (4 cm)

VIVALDI

RECOMMENDED FOR

EAN13

CODE



	8051272183023	PLANA2
EN54-24	8051272183030	PLANA2T
	8052015550638	PLANA2B
EN54-24	8052015550584	PLANA2TB

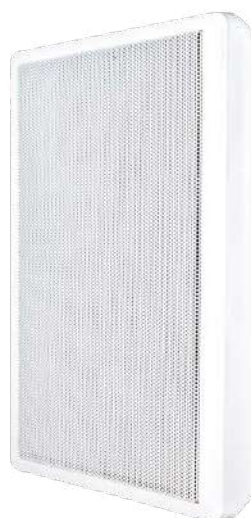
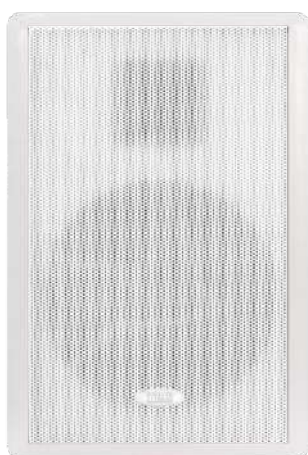

	PLANA2	PLANA2T
Descrizione / Description	Diffusore rettangolare piatto, 2 vie, da parete, HiFi / Flat rectangular speaker, 2 way, wall, HiFi	
Certificato EN54 / EN54 Certificate	---	si / yes
Woofers	13,5 cm	13,5 cm
Tweeter	1,3 cm mylar	1,3 cm mylar
Magnete / Magnet	ceramico / ceramic	ceramico / ceramic
Membrana / Diaphragm	carta trattata / treated paper	carta trattata / treated paper
Potenza RMS / musicale RMS / Music Power	30W/60W	8W 16W peak, max 97dB
Amplificazione consigliata Recommended amplification	da 10 a 40W RMS 10 to 40W RMS	---
Impedenza / Tensione trasformatore Impedance / Transformer voltage	8Ω	100V
Risposta in frequenza / Sensibilità Frequency Response / Sensitivity	80-20000Hz/85dB	70-20000Hz/85dB
Dimensioni (LxHxP) / Size (WxHxD)	185x275x40 mm	185x275x40 mm
Peso / Weight	0,9 kg	0,9 kg
Colore / Color	bianco RAL9016 / white RAL9016 nero RAL9005 / black RAL9005	bianco RAL9016 / white RAL9016 nero RAL9005 / black RAL9005
Cabinet	ABS V0 con griglia di protezione zincata verniciata / ABS V0 with painted galvanized grille	



RECOMMENDED FOR	EAN13	CODE
	8051272182897	MINI8W bianco / white
	IP44 8051272189643	MINI8W.IP
	8051272180169	MINI8B nero / black
IP44	8051272189636	MINI8B.IP
EN54-24	8051272182606	LARA9TB nero / black
EN54-24	8051272180091	LARA9TW bianco / white
EN54-24	8051272180107	LARA10TB nero / black
EN54-24	8051272182590	LARA10TW bianco / white



	MINI8	LARA9T	LARA10T
Descrizione / Description	Diffusore, 2 vie HiFi con staffa da parete inclinabile speaker, 2 way HiFi with tilting wall bracket	Proiettore di suono con staffa per fissaggio da parete 2 vie HiFi, IP32 Sound projector with bracket for wall mounting 2 way HiFi, IP32	
Certificato EN54 / EN54 Certificate	---	si / yes	si / yes
Woofer	8 cm	10 cm	13,5 cm
Tweeter	1,3 cm	2,5 cm	2,5 cm
Membrana / Diaphragm	mylar	mylar	mylar
Potenza RMS / musicale RMS / Music Power	20W/40W	30W/60W	40W/80W
Potenza nominale / peak Nominal power / peak	1,5/3/6W 12W peak, max 96dB	1,25/2,5/5/10W 20W peak, max 104dB	2,5/5/10/20W 40W peak, max 109dB
Amplificazione consigliata Recommended amplification	da 10 a 30W RMS / 10 to 30W RMS	da 10 a 30W RMS / 10 to 30W RMS	da 10 a 40W RMS / 10 to 40W RMS
Impedenza / Tensione trasformatore Impedance / Transformer voltage	8Ω - 100V selezionabile / selectable	8Ω - 100V selezionabile / selectable	8Ω - 100V selezionabile / selectable
Risposta in frequenza / Sensibilità Frequency Response / Sensitivity	120-20000Hz/85dB	80-20000Hz -10dB/91dB	70-20000Hz - 10dB/92dB
Angolo di dispersione Dispersion angle	90° (V/O)	90°Vx90°O (120° fino a 3 KHz)	90°Vx90°O (120° fino a 3 KHz)
Dimensioni (LxHxP) senza staffa Size (WxHxD) without bracket	94x140x100 mm	151x215x130 mm	176x251x161 mm
Dimensioni (LxHxP) con staffa Size (WxHxD) with bracket	---	151x245x163 mm	176x286x190 mm
Peso / Weight	0,7 kg	1,9 kg	2,6 kg
Colore / Color	bianco RAL9003 / white RAL9003 nero RAL9005 / black RAL9005	bianco RAL9003 / white RAL9003 nero RAL9005 / black RAL9005	bianco RAL9003 / white RAL9003 nero RAL9005 / black RAL9005
Cabinet	ABS V0 con griglia di protezione zincata verniciata / ABS V0 with painted galvanized grille		



diffusori da parete HiFi con staffa
wall-mounted speakers HiFi with bracket

VIVALDI

RECOMMENDED FOR	EAN13	CODE	
	8051272180176	AMBRA9TB nero / black	
	8051272180183	AMBRA9TW bianco / white	
	8051272182637	AMBRA10TB nero / black	
	8051272182651	AMBRA10TW bianco / white	
	8051272182675	AMBRA16TB nero / black	
	8051272182699	AMBRA16TW bianco / white	
	EN54-24	8051272182750	AMBRA21TB nero / black
	EN54-24	8051272182767	AMBRA21TW bianco / white
	EN54-24	8051272188714	CP21TB nero / black
	EN54-24	8051272188721	CP21TW bianco / white
		8051272189667	CP12B staffa di ricambio per CP21TB
		8051272189650	CP12W staffa di ricambio per CP21TW



	AMBRA9T	AMBRA10T	AMBRA16T	AMBRA21T	CP21T
Descrizione / Description	Diffusore da parete con staffa per fissaggio a parete 2 vie HiFi Wall speaker with bracket for wall fixing 2 way HiFi				Sistema professionale con 3 AMBRA21 in configurazione cluster 3 speakers kit AMBRA21T in cluster configuration
Certificato EN54 / EN54 Certificate	---	---	---	si / yes	si / yes
Woofers	11 cm	14 cm	16,5 cm	20 cm	---
Tweeter	2,5 cm	2,5 cm	2,5 cm	a cupola 3,2 cm dome 3,2 cm	---
Membrana / Diaphragm	alluminio e seta aluminium and silk	alluminio e seta aluminium and silk	alluminio e seta aluminium and silk	alluminio e seta aluminium and silk	---
Potenza RMS / musicale RMS / Music Power	40W/80W	50W/100W	60W/120W	80W/160W	---
Potenza nominale / peak Nominal power / peak	5/10/20W 40W peak, max 106dB	10/20/40W 80W peak, max 108dB	10/20/40W 80W peak, max 111dB	5/10/20/40W 80W peak, max 111dB	120W 240W peak
Amplificazione consigliata Recommended amplification	da 10 a 50W RMS 10 to 50W RMS	da 10 a 60W RMS 10 to 60W RMS	da 10 a 80W RMS 10 to 80W RMS	da 10 a 120W RMS 10 to 120W RMS	---
Impedenza / Tensione trasformatore Impedance / Transformer voltage	8Ω - 100V selezionabile selectable	8Ω - 100V selezionabile selectable	8Ω - 100V selezionabile selectable	8Ω - 100V selezionabile selectable	100V
Risposta in frequenza / Sensibilità Frequency Response / Sensitivity	60-20000Hz/89dB	55-20000Hz/91dB	50-20000Hz/92dB	60-20000Hz-10dB/92dB	---
Angolo di dispersione Dispersion angle	90°Vx90°O (120° fino a 3 KHz)	90°Vx90°O (120° fino a 3 KHz)	90°Vx90°O (120° fino a 3 KHz)	90°Vx90°O (120° fino a 3 KHz)	---
Dimensioni (LxHxP) senza staffa Size (WxHxD) without bracket	130x195x115 mm	170x240x147 mm	208x320x185 mm	287x409x250 mm	---
Dimensioni (LxHxP) con staffa Size (WxHxD) with bracket	130x215x130 mm	170x270x170 mm	208x334x200 mm	287x448x288 mm	---
Peso / Weight	1,5 kg	2,7 kg	4,3 kg	6,3 kg	26,5 kg
Colore / Color	bianco / white RAL9003 nero / black RAL9005	bianco / white RAL9003 nero / black RAL9005	bianco / white RAL9003 nero / black RAL9005	bianco / white RAL9003 nero / black RAL9005	bianco / white RAL9003 nero / black RAL9005
Cabinet	ABS V0 con griglia di protezione zincata verniciata / ABS V0 with painted galvanized grille				



RECOMMENDED FOR	EAN13	CODE
<p>EN54</p>	EN54-24 IP65	8051272189292 FLORA10TB nero / black
	EN54-24 IP65	8051272189308 FLORA10TW bianco / white
	EN54-24 IP65	8051272182903 FLORA13TB nero / black
	EN54-24 IP65	8051272182910 FLORA13TW bianco / white
	EN54-24 IP65	8051272187731 FLORA16TB nero / black
	EN54-24 IP65	8051272187748 FLORA16TW bianco / white
	IP65	8052015550614 FLORA16SPB nero / black
	IP65	8052015550607 FLORA16SPW bianco / white



	FLORA10T	FLORA13T	FLORA16T	FLORA16SP
Descrizione / Description	Proiettore di suono professionale, 2 vie HiFi con staffa per fissaggio da parete Professional 2 way HiFi sound projector with bracket for wall mounting			
Grado di protezione / Protection degree	IP65	IP65	IP65	IP65
Rotazione staffa / Bracket rotation	3 posizioni (-30°, 0°, +30°) Basculante 180°O/180°V 3 positions (-30°, 0°, +30°) Tilting 180°W/180°V		90° verticale, 170° orizzontale adjustable 0-90° vertical, 0-170° horizontal	
Applicazioni / Applications	Ideale per applicazioni outdoor anche in aree marine. Resistente ad agenti corrosivi quali cloro e salsedine Ideal for outdoor applications even in marine areas. Resistant to corrosive agents such as chlorine and salt			
Certificato EN54 / EN54 Certificate	si / yes	si / yes	si / yes	---
Woofer	10,5 cm	13,5 cm	16,5 cm	16,5 cm
Tweeter	a cupola 2,5 cm / dome 2,5 cm	a cupola 2,5 cm / dome 2,5 cm	a cupola 2,5 cm / dome 2,5 cm	---
Membrana / Diaphragm	poliammide / polyamide	titanio / titanium	titanio / titanium	---
Altoparlante / Speaker	---	---	---	coax con magneti neodimio, cestello in alluminio coax with neodymium magnets, aluminum basket
Driver	---	---	---	da 3,4 cm a compressione in titanio 3.4 cm compression titanium
Potenza RMS / musicale RMS / Music Power	30W/60W	60W/120W	60W/120W	150W/300W
Potenza nominale / peak Nominal power / peak	5/10/20W 40W peak, max 105dB	2/4/8/16/32W 64W peak, max 105dB	4/8/16/32W 64W peak, max 108dB	---
Amplificazione consigliata Recommended amplification	da 10 a 50W RMS 10 to 54W RMS	da 10 a 80W RMS 10 to 80W RMS	da 10 a 80W RMS 10 to 80W RMS	da 80 a 200W RMS 80 to 200W RMS
Impedenza / Tensione trasformatore Impedance / Transformer voltage	8Ω - 100V selezionabile selectable	8Ω - 100V selezionabile selectable	8Ω - 100V selezionabile selectable	8Ω
Risposta in frequenza / Sensibilità Frequency Response / Sensitivity	75-20000Hz -10dB/85dB	65-20000Hz -10dB/87dB	60-20000Hz -10dB/90dB	90-20000 Hz/93dB
Angolo di dispersione / Dispersion angle	105°Vx90°O (120° fino a 3 KHz)	105°Vx90°O (120° fino a 3 KHz)	105°Vx90°O (120° fino a 3 KHz)	100° (V/O)
Dimensioni (LxHxP) senza staffa Size (WxHxD) without bracket	170x250x147 mm	186x257x165 mm	222x315x235 mm	222x315x235 mm
Dimensioni (LxHxP) con staffa Size (WxHxD) with bracket	170x243x180 mm	186x257x187 mm	222x335x295 mm	222x335x295 mm
Peso / Weight	2,4 kg	2,4 kg	3,0 kg	4,5 kg
Colore / Color	bianco RAL9003 / white RAL9003 nero RAL9005 / black RAL9005		bianco RAL9003 / white RAL9003 nero RAL9005 / black RAL9005	
Cabinet	ABS 5VB, con griglia di protezione in alluminio / ABS 5VB with aluminum grille			



diffusori da parete HiFi con staffa, 3 vie con subwoofer
HiFi wall speakers with bracket, 3-way with subwoofer

VIVALDI

RECOMMENDED FOR

EAN13

CODE



IP66		8052015550027	ANNA13TB nero / black
IP66		8052015550010	ANNA13TW bianco / white
IP66		8052015550041	ANNA16TB nero / black
IP66		8052015550034	ANNA16TW bianco / white
IP66		8052015550065	ANNA20TB nero / black
IP66		8052015550058	ANNA20TW bianco / white

3 vie
con subwoofer
3 Way
with subwoofer



	ANNA13T	ANNA16T	ANNA20T
Descrizione / Description	Proiettore di suono professionale, in versione Hi-Fi, 3 vie, con subwoofer, staffa per fissaggio a parete in dotazione Professional sound projector, Hi-Fi version, 3 way, with subwoofer, bracket for wall mounting included		
Grado di protezione / Protection degree	IP66	IP66	IP66
Applicazioni / Applications	Ideale per applicazioni outdoor anche in aree marine. Resistente ad agenti corrosivi quali cloro e salsedine Ideal for outdoor applications even in marine areas. Resistant to corrosive agents such as chlorine and salt		
Subwoofer passivo	ellittico convesso 10,5x15 cm (LxH) convex elliptical 10.5x15 cm (WxH)	ellittico convesso 12x18 cm (LxH) convex elliptical 12x18 cm (WxH)	ellittico convesso 16,5x23,5 cm (LxH) convex elliptical 16,5x23,5 cm (WxH)
Woofer	13 cm in polipropilene, finitura graffite 13 cm in polypropylene, graphite finish	16,5 cm in polipropilene, finitura graffite 16,5 cm in polypropylene, graphite finish	20,5 cm in polipropilene, finitura graffite 20,5 cm in polypropylene, graphite finish
Tweeter	2,5 cm a cupola, in neodimio e seta 2.5 cm domed, in neodymium and silk	2,5 cm a cupola, in neodimio e seta 2.5 cm domed, in neodymium and silk	2,8 cm a cupola, in neodimio e seta 2.8 cm domed, in neodymium and silk
Potenza RMS / musicale RMS / Music Power	60W/120W	80W/160W	80W/160W
Potenza nominale / peak Nominal power / peak	2,5/5/10/20W 40W peak, max 104dB	5/10/20/40W 80W peak, max 107dB	6,25/12,5/25/50W 100W peak, max 108dB
Amplificazione consigliata Recommended amplification	da 10 a 80W RMS / from 10 to 80W RMS		
Impedenza / Tensione trasformatore Impedance / Transformer voltage	8Ω - 100V selezionabile / selectable	8Ω - 100V selezionabile / selectable	8Ω - 100V selezionabile / selectable
Risposta in frequenza / Sensibilità Frequency Response / Sensitivity	55-20000Hz -85dB	50-20000Hz -86dB	45-20000Hz -87dB
Angolo di dispersione / Dispersion angle	105°Vx90°O (120° - 3 KHz) 105°Vx90°H (120° up to 3 KHz)	105°Vx90°O (120° - 3 KHz) 105°Vx90°H (120° up to 3 KHz)	105°Vx90°O (120° - 3 KHz) 105°Vx90°H (120° up to 3 KHz)
Dimensioni (LxHxP) senza staffa Size (WxHxD) without bracket	170x258x168 mm	198x285x195 mm	250x381x250 mm
Dimensioni (LxHxP) con staffa Size (WxHxD) with bracket	170x258x185 mm	198x285x215 mm	250x381x280 mm
Peso / Weight	2,76 kg	3,45 kg	5,01 kg
Colore / Color	bianco RAL9003 con bordi RAL7035 / white RAL9003 with edges RAL7035 nero RAL9005 / black RAL9005		
Cabinet	ABS, staffa e griglia in alluminio verniciato / ABS, bracket and aluminium grille painted		
Note	i diffusori della serie ANNA sono dotati di un altoparlante subwoofer passivo pertanto danno la miglior resa sulle basse frequenze installandoli a parete o ad angolo su soffitto / ANNA series speakers are equipped with a passive subwoofer therefore give the best performance on the bass frequencies by installing them on the wall or at an angle on the ceiling		



RECOMMENDED FOR

EAN13

CODE



EN54

EN54-24	IP65	8051272182927	PS10
EN54-24	IP65	8051272182934	PS20BIDI
EN54-24	IP66	8051272189346	PSL20BIDI



	PS10	PS20BIDI	PSL20BIDI
Descrizione / Description	Proiettore di suono con staffa per fissaggio a parete / Sound projector with bracket for wall mounting		
Grado di protezione / Protection degree	IP65	IP65	IP66
Applicazioni Applications	Per ambienti interni o esterni (anche per esposizione al cloro) For indoor or outdoor environments (also for exposure to chlorine)		
Certificato EN54/ EN54 Certificate	si / yes	si / yes	si / yes
Woofers	coax 13,5 cm	coax 2x13,5 cm	coax 2x16,5 cm
Potenza nominale / peak Nominal power / peak	1,25/2,5/5/10W 20W peak, max 109dB	2,5/5/10/20W 40W peak, max 111dB	5/10/20W 40W peak, 109dB
Impedenza / Tensione trasformatore Impedance / Transformer voltage	100V	100V	100V
Risposta in frequenza / Sensibilità Frequency Response / Sensitivity	100-19000Hz -10dB/96dB	100-19000Hz -10dB/94dB	110-15000Hz -10dB/92dB
Angolo di dispersione / Dispersion angle	118°(V/O) 2KHz	118°(V/O) 2KHz	118°(V/O) 2KHz
Dimensioni (LxHxP) senza staffa Size (WxHxD) without bracket	151x150x181 mm	151x150x218 mm	170x170x252 mm
Dimensioni (LxHxP) con staffa Size (WxHxD) with bracket	151x210x181 mm	151x210x218 mm	170x250x252 mm
Peso / Weight	2,2 kg	3,4 kg	2,8 kg
Colore / Color	bianco / white RAL9003	bianco / white RAL9016	bianco / white RAL9016
Cabinet	alluminio verniciato con griglia di protezione zincata verniciata / aluminium with painted galvanized grille		
Note	---	---	fornito con connetting block (morsetto ceramico e fusibile termico) e cavo da 0,30mt included with connetting block (ceramic clamp and thermal fuse) and 0.30mt cable



colonne sonore HiFi per interni ed esterni
HiFi columns for indoor and outdoor use

VIVALDI

	EAN13	CODE
IP65	8051272182835	CS10T
IP65	8051272182859	CS20T
IP65	8051272182866	CS40
EN54-24 IP65	8051272182873	CS40T

RECOMMENDED FOR

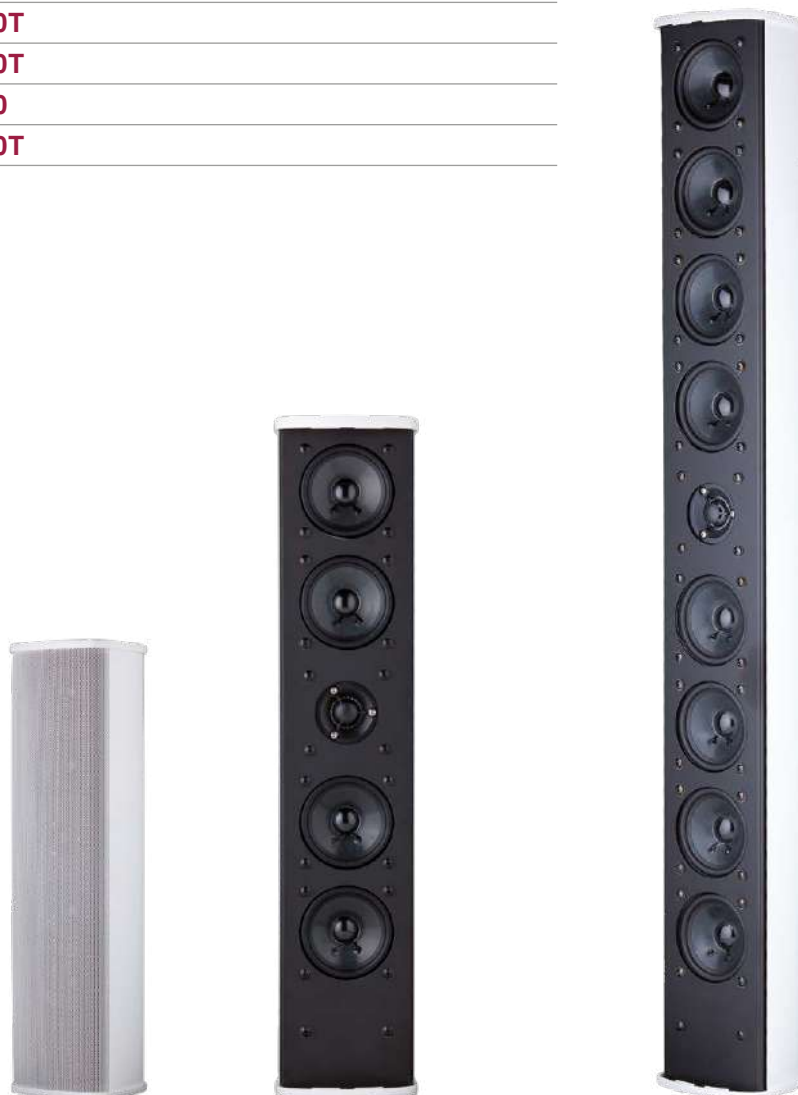

	CS10T	CS20T	CS40	CS40T
Descrizione / Description	Diffusore a colonna, di design e qualità sonora elevata. 2 vie HiFi con staffa per fissaggio a parete orientabile Column speaker, design and high sound quality. 2 way HiFi with bracket for wall mounting adjustable			
Grado di protezione / Protection degree	IP65	IP65	IP65	IP65
Applicazioni / Applications	Ideale per luoghi di culto, parcheggi all'aperto o interrati, ambienti umidi, esposizione alla pioggia, piscine. Ideal for places of worship, outdoor or underground parking, humid environments, exposure to rain, swimming pools.			
Certificato EN54 / EN54 Certificate	---	---	---	si / yes
Altoparlanti / Speakers	nr. 3 (2 woofer + 1 tweeter)	nr. 5 (4 woofer + 1 tweeter)	nr. 9 (8 woofer + 1 tweeter)	
Potenza RMS / musicale RMS / Music Power	10W/20W	20W/40W	160W/320W	---
Potenza nominale / peak Nominal power / peak	1,25/2,5/5/10W 20W peak, max 102dB	2,5/5/10/20W 40W peak, max 109dB	---	5/10/20/40W 80W peak, max 113dB
Impedenza / Tensione trasformatore Impedance / Transformer voltage	8Ω/100V	8Ω/100V	4Ω	100V
Risposta in frequenza / Sensibilità Frequency Response / Sensitivity	130-20000Hz/89dB/106dB	110-20000Hz/92dB/110dB	100-20000Hz/94dB/114dB	100-20000Hz/94dB/114dB
Angolo di dispersione/ Dispersion angle	70°(V)x100°(O)	45°(V)x100°(O)	45°(V)x100°(O)	45°(V)x100°(O)
Dimensioni (LxHxP) senza staffa Size (WxHxD) without bracket	121x380x109 mm	121x570x109 mm	121x950x109 mm	121x950x109 mm
Peso / Weight	3,6 kg	5,2 kg	7,5 kg	7,5 kg
Colore / Color	bianco RAL9003 white RAL9003	bianco RAL9003 white RAL9003	bianco RAL9003 white RAL9003	bianco RAL9003 white RAL9003
Cabinet	alluminio verniciato con griglia di protezione zincata verniciata / aluminium with painted galvanized grill			



RECOMMENDED FOR

EAN13

CODE



EN54-24 IP65	8051272182996	PH15MK2
EN54-24 IP65	8051272183009	PH30MK2
EN54-24 IP65	8051272183016	PH50HIFI
IP65	8051272187915	PH50M
IP65	8051272187922	PH100M



	PH15MK2	PH30MK2	PH50HIFI	PH50M	PH100M
Descrizione / Description	Diffusore a tromba, stagno resistente ai raggi UV / Horn speaker, UV resistant sealed				
Grado di protezione / Protection degree	IP65	IP65	IP65	IP65	IP65
Caratteristiche / Features	---	---	HiFi	---	---
Certificato EN54 / EN54 Certificate	si / yes	si / yes	si / yes	---	---
Woofers	---	---	16,5 cm	---	---
Tweeter	---	---	a compressione compression	---	---
Potenza RMS / musicale RMS / Music Power	30W/60W	40W/80W	---	---	---
Potenza nominale / peak Nominal power / peak	1,9/3,8/7,5/15W 30 peak, max 121dB	3,8/7,5/15/30W 60 peak, max 123dB	15/30/50W 100W peak, max 118dB	15/30/50W 100W peak, max 131dB	50/75/100W 150 peak, max 133dB
Impedenza / Tensione trasformatore Impedance / Transformer voltage	8Ω/100V	8Ω/100V	100V	100V	100V
Risposta in frequenza / Sensibilità Frequency Response / Sensitivity	250-8000Hz 10dB/106dB	250-8000Hz 10dB/108dB	100-16000Hz 10dB/101dB	200-6000Hz 10dB/111dB	200-6000Hz 10dB/111dB
Angolo di dispersione / Dispersion angle	110°(V) 90°(O) 2KHz.	90°(V) 100°(O) 2KHz	100°(V) 60°(O) 2KHz	90°(V) 100°(O) 2KHz	90°(V) 100°(O) 2KHz
Dimensioni (LxHxP) senza staffa Size (WxHxD) without bracket	220x164x231 mm	284x206x286 mm	356x268x294 mm	---	---
Dimensioni (LxHxP) con staffa Size (WxHxD) with bracket	220x181x231 mm	284x230x286 mm	356x280-312x294 mm	540x470 mm	540x470 mm
Peso / Weight	1,4 kg	1,8 kg	3,9 kg	4,0 kg	4,0 kg
Colore / Color	bianco / white RAL9035	bianco / white RAL9035	bianco / white RAL7035	bianco / white RAL9010	bianco / white RAL9010
Cabinet	ABS V0 con staffa ad U in acciaio inox verniciato ABS V0, U-bracket in painted stainless steel			alluminio verniciato con griglia di protezione zincata verniciata / aluminium with painted galvanized grille	
Profilo Profile	ellittico in ABS V0 elliptical ABS V0	ellittico in ABS V0 elliptical ABS V0	rettangolare in ABS V0 rectangular ABS V0	ellittico in alluminio elliptical aluminium	ellittico in alluminio elliptical aluminium



diffusori a tromba professionali stagni per amplificazioni a lunga gittata
professional waterproof horn loudspeakers for long range amplification

VIVALDI

RECOMMENDED FOR **EAN13** **CODE**



		8052015550348	PH208TPRO
EN54-24	IP65	8051272189162	PH210TPRO
	IP55	8051272180503	PH212TPRO
		8051272189070	ST212 supporto da soffitto per PH212TPRO

120dB
full power 8Ω



130dB
full power 8Ω



132dB
full power 8Ω



	PH208TPRO	PH210TPRO	PH212TPRO
Descrizione / Description	Diffusore a tromba 2 vie professionale a tenuta stagna per amplificazioni a lunga gittata resistente ai raggi UV Professional watertight 2 way horn speaker, waterproof, for long-range amplification resistant to UV rays		
Grado di protezione / Protection degree	IP65	IP65	IP55
Applicazioni / Applications	ideale per stadi, palazzetti dello sport, piazze... ideal for stadiums, sports halls, squares...	ideale per stadi, palazzetti dello sport, piazze... ideal for stadiums, sports halls, squares...	ideale per stadi, palazzetti dello sport, piazze... ideal for stadiums, sports halls, squares...
Certificato EN54 / EN54 Certificate	---	si / yes	---
Potenza RMS / musicale RMS / Music Power	180W/360W	250W/500W	250W/500W
Potenza nominale / peak Nominal power / peak	15/30/60/120W 240W peak	25/50/100/200W 400W peak	250W 500W peak
Impedenza / Tensione trasformatore Impedance / Transformer voltage	8Ω/100V	8Ω/100V	8Ω/100V
Risposta in frequenza / Sensibilità Frequency Response / Sensitivity	80-18000 Hz +/-10dB / 98dB	80-18000Hz +/-10dB 96 dB - SPL max @200W: 118 dB	70-18000Hz +/-10dB / 102dB
Angolo di dispersione / Dispersion angle	60° (V/O) 1KHz - 45° (V/O) 5KHz	60° (V/O) 1KHz - 45° (V/O) 5KHz	60° (V/O) 1KHz - 45° (V/O) 5KHz
Dimensioni (LxHxP) / Size (WxHxD)	300x302x334 mm con staffa / with bracket	355x355x360 mm con staffa / with bracket	450x450x670 mm
Peso / Weight	10 kg	13,5 kg	28,5 kg
Colore / Color	bianco / white RAL7035	bianco / white RAL7035	bianco / white RAL7016
Cabinet	ABS V0 con griglia di protezione zincata verniciata ABS V0 with painted galvanized grille	ABS V0 con griglia di protezione zincata verniciata ABS V0 with painted galvanized grille	metallico verniciato grigio, tromba ABS con griglia di protezione zincata verniciata grey metal, ABS horn with painted galvanized grille
Note	fornito con staffa included with bracket	fornito con staffa included with bracket	adatte per staffaggio a vite catena metallica con moschettone suitable for screw clamping metal chain with carabiner



RECOMMENDED FOR

EAN13

CODE



EN54-24 IP33

8051272181432	AIRPOWER16TB nero / black
8051272181425	AIR20T



AIRPOWER16TB (black)



	AIRPOWER16T	AIR20T
Descrizione / Description	Proiettore di suono a sospensione, 2 vie Pendant sound projector, 2 way.	Diffusore da sospensione, completo di passacavo, IP33 Pendant speaker, complete with cable gland, IP33
Certificato EN54 / EN54 Certificate	---	si / yes
Woofers	16 cm	coax 16,5 cm
Tweeter	3 cm titanio e neodimio 3 cm titanium and neodymium	---
Potenza RMS / musicale / RMS / Music Power	80W/160W	---
Potenza nominale 100V / peak Nominal power 100V / peak	2/4/8/16/32W 64W peak	10/20W 40W peak, max 112dB
Potenza nominale 70V / peak Nominal power 70V / peak	2/4/8/16/32W 64W peak	---
Amplificazione consigliata Recommended amplification	da 10 a 120W RMS 10 to 120W RMS	---
Impedenza / Tensione trasformatore Impedance / Transformer voltage	8Ω/70V/100V	100V
Risposta in frequenza / Sensibilità Frequency Response / Sensitivity	45-18000Hz / 1W/1m 90dB. Max105dB	110-20000Hz -10dB / 95dB
Angolo di dispersione / Dispersion angle	360°(O)x140°(V)	120° a cono / cone
Dimensioni (DxH) / Size (DxH)	308x365 mm	177x247 mm
Lunghezza cavo / Cable length	180 cm	180 cm
Peso / Weight	2,4 kg	1,6 kg
Colore / Color	nero RAL9005 / black RAL9005	bianco RAL9010 / white RAL9010
Cabinet	Polipropilene con griglia di protezione zincata verniciata polypropilene with painted galvanized grille	ABS V0 con griglia di protezione in alluminio ABS V0 with painted aluminum grille



RECOMMENDED FOR

EAN13

CODE



	IP66	8052015551130	AIR30TB nero / black
	IP66	8052015551147	AIR30TW bianco / white
	IP66	8052015551154	AIR40TB nero / black
	IP66	8052015551161	AIR40TW bianco / white
	EN54-24 IP66	8051272189728	AIR50TB nero / black
	EN54-24 IP66	8052015550072	AIR50TW bianco / white

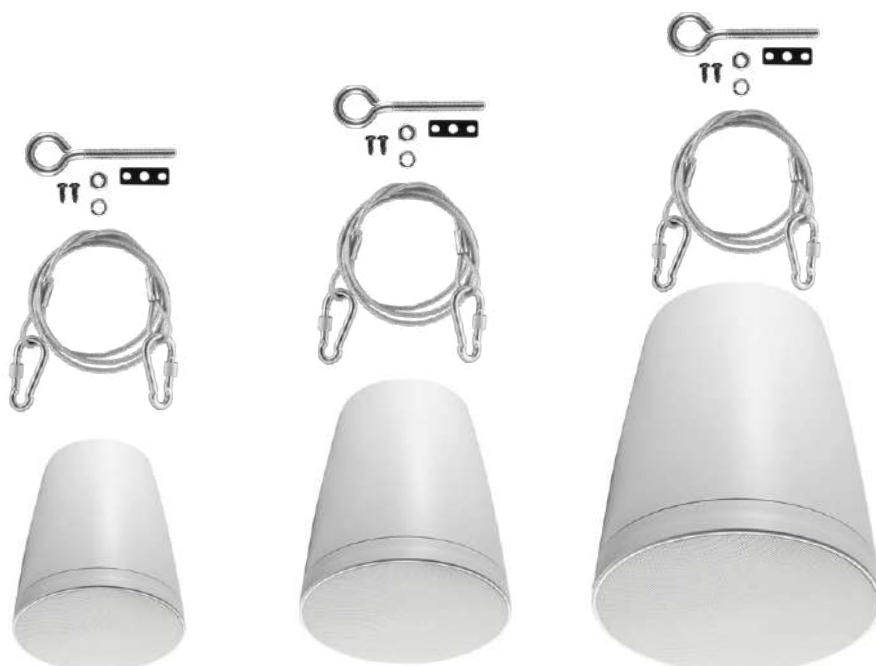

	AIR30T	AIR40	AIR50T
Descrizione / Description	Diffusore da sospensione, 2 vie completo di passacavo e anello, IP66 Pendant speaker, 2 way, complete with cable gland and metal ring, IP66	Diffusore da sospensione, 2 vie completo di passacavo e anello, IP66 Pendant speaker, 2 way, complete with cable gland and metal ring, IP66	Diffusore da sospensione, 2 vie completo di passacavo e anello, IP66 Pendant speaker, 2 way, complete with cable gland and metal ring, IP66
Certificato EN54 / EN54 Certificate	no	no	si / yes
Woofers	13 cm	16,5 cm	20 cm
Tweeter	2,8 cm	2,8 cm	2,8 cm
Potenza RMS / musicale / RMS / Music Power	60W/120W	60W/120W	80W/160W
Potenza nominale 70V/100V / peak Nominal power 70V/100V / peak	3,7/7,5/1530W 60W peak, max 102dB	5/10/20/40W 80W peak, max 105dB	6,25/12,5/25/50W 100W peak, max 107dB
Impedenza / Tensione trasformatore Impedance / Transformer voltage	8Ω/70V/100V	8Ω/70V/100V	8Ω/70V/100V
Risposta in frequenza / Sensibilità Frequency Response / Sensitivity	80-20000 Hz -3dB / 84dB	51-20000 Hz -3dB / 85dB	44-20000Hz -10dB / 86dB
Angolo di dispersione / Dispersion angle	120° a cono / cone	120° a cono / cone	120° a cono / cone
Dimensioni (DxH) / Size (DxH)	190x250 mm	230x300 mm	270x343 mm
Lunghezza cavo / Cable length	110 cm	110 cm	110 cm
Peso / Weight	2,5 Kg	4 Kg	5,0 kg
Colore / Color	bianco RAL9010 / white RAL9010 nero RAL9005 / black RAL9005	bianco RAL9010 / white RAL9010 nero RAL9005 / black RAL9005	bianco RAL9010 / white RAL9010 nero RAL9005 / black RAL9005
Cabinet	ABS V0	ABS V0	ABS V0



BOOK
NOW
FOR
CHRISTMAS
FUNCTION
ROOM
AVAILABLE

Subwoofer
pump

Up
the
Bass



RECOMMENDED FOR	EAN13	CODE
	8052015550249	SUBGIADA20F
	8052015550256	SUBGIADA20F.R (min 10pz)
	8052015550263	SUBGIADA20FA
	8052015550270	SUBGIADA20FA.R (min 10pz)
	8051272183368	SUBROUND20F
	8051272183375	SUBROUND20F.R (min 10pz)
	8051272187090	SUBROUND20FA
	8051272188844	SUBROUND20FA.R (min 10pz)
	8051272189957	SR20 scatola da incasso per SUBGIADA
	8052015550287	SR30 scatola da incasso per SUBROUND



	SUBGIADA20F	SUBGIADA20FA	SUBROUND20F	SUBROUND20FA
Descrizione / Description	Subwoofer rettangolare, da incasso, frameless Rectangular subwoofer, recessed, frameless	Kit subwoofer rettangolare, da incasso, frameless Kit in-ceiling rectangular subwoofer, frameless series	Subwoofer rotondo, da incasso, frameless Round subwoofer, recessed, frameless	Kit subwoofer rotondo, da incasso, frameless Kit in-ceiling round subwoofer, frameless series
	passivo / passive	attivo / active	passivo / passive	attivo / active
Woofer	20,5 cm	20,5 cm	20,5 cm	20,5 cm
Potenza RMS / RMS Power	80W	100W	80W	100W
Risposta in frequenza / Frequency response	40-200Hz	40-200Hz	40-200Hz	40-200Hz
Max output level	110dB	110dB	110dB	110dB
Angolo di dispersione / Dispersion angle	180° (V/O)	180° (V/O)	180° (V/O)	180° (V/O)
Alimentazione / Power supply	---	AL5B included	---	AL5B included
Dimensioni (LxHxP) - (DxP) Size (WxHxD) - (DxD)	242x362x105 mm	242x362x105 mm	277x105 mm	277x115 mm
Foro da incasso (LxH) - (D) / Recessed hole (WxH) - (D)	220x340 mm	220x340 mm	258 mm	258 mm
Peso / Weight	1,9 kg	1,9 kg	1,9 kg	1,9 kg
Cabinet	ABS V0 con griglia di protezione zincata verniciata / ABS V0 with painted galvanized grille			
Colore / Color	bianco / white RAL 9016	bianco / white RAL 9016	bianco / white RAL 9016	bianco / white RAL 9016
Incasso su muratura Recessed on masonry	SR20 (pag.182)	SR20 (pag.182)	SR30 (pag.182)	SR30 (pag.182)
Incasso su cartongesso Recessed on plasterboard	non servono accessori, il diffusore nel retro è dotato di ganci per l'ancoraggio stabile no accessories needed, the speaker is provided with hook shaped anchors for stable fixing in the rear			
Temperatura di lavoro Working temperature	da -20° a +65°			



RECOMMENDED FOR **EAN13** **CODE**



	8051272183399	SUBGIADA20SPF
	8051272188851	SUBGIADA20SPF.R (min 10pz)
	8052015550188	SUBGIADA20SPFA
	8052015550195	SUBGIADA20SPFA.R (min 10pz)
	8052015550201	SUBROUND20SPF
	8052015550218	SUBROUND20SPF.R (min 10pz)
	8052015550225	SUBROUND20SPFA
	8052015550232	SUBROUND20SPFA.R (min 10pz)
	8051272189957	SR20 scatola da incasso per SUBGIADA
	8052015550287	SR30 scatola da incasso per SUBROUND

*attenzione con questa tipologia di prodotto è obbligatorio installare la scatola da incasso, per evitare danneggiamenti durante l'uso.
attention with this type of product it is mandatory to install the flush-mounted box, to avoid damage during use.



	SUBGIADA20SPF	SUBGIADA20SPFA	SUBROUND20SPF	SUBROUND20SPFA
Descrizione / Description	Subwoofer rettangolare, da incasso a controsoffitto, frameless . Rectangular subwoofer, recessed to false ceiling, frameless	Kit subwoofer rettangolare, da incasso a controsoffitto, frameless Kit rectangular subwoofer, recessed false ceiling, frameless	Subwoofer rotondo, da incasso a controsoffitto, frameless . Round subwoofer, recessed to false ceiling, frameless	Kit subwoofer rotondo, da incasso a controsoffitto, frameless Kit round subwoofer, recessed false ceiling, frameless
	passivo / passive	attivo / active	passivo / passive	attivo / active
Applicazioni / Applications	Ideale per sistemi Home Cinema o diffusions sonore di alta qualità (in abbinamento ai diffusori) Ideal for home cinema systems or high quality sound system (in combination with speakers).			
Woofer	20 cm a doppia bobina 8Ω 20 cm with double coil 8Ω	20 cm	20 cm a doppia bobina 8Ω 20 cm with double coil 8Ω	20 cm
Potenza RMS / RMS Power	250W	140+140W tramite / via E80S	250W	140+140W tramite / via E80S
Risposta in frequenza / Frequency response	35-200Hz	35-200Hz	35-200Hz	35-200Hz
Max output level	---	112dB	---	112dB
Sensibilità / Sensitivity	88dB	---	88dB	---
Angolo di dispersione / Dispersion angle	180° (V/O)	180° (V/O)	180° (V/O)	180° (V/O)
Alimentazione / Power supply	---	AL9B included	---	AL9B included
Dimensioni (LxHxD) - (DxD) Size (WxHxD) - (DxD)	242x362x135 mm	242x362x135 mm	284x104 mm	284x104 mm
Foro da incasso (LxH) - (D) / Recessed hole (WxH) - (D)	220x340 mm	220x340 mm	258 mm	258 mm
Peso / Weight	2,1 kg	2,7 kg	2,0 kg	2,0 kg
Cabinet	ABS V0 con griglia di protezione zincata verniciata / ABS V0 with painted galvanized grille			
Colore / Color	bianco / white RAL 9016	bianco / white RAL 9016	bianco / white RAL 9016	bianco / white RAL 9016
Incasso su muratura Recessed on masonry	SR20* (pag.182)	SR20* (pag.182)	SR30* (pag.182)	SR30* (pag.182)
Incasso su cartongesso Recessed on plasterboard	SR20* (pag.182)	SR20* (pag.182)	SR30* (pag.182)	SR30* (pag.182)
Temperatura di lavoro Working temperature	da -20° a +65°			



RECOMMENDED FOR	EAN13	CODE
	8051272186451	SUB6AW EOL
	8052015550577	MINISUB8AB
	8052015550560	MINISUB8AW
	8052015550546	SUB8ALB
	8052015550539	SUB8APB
	8052015550553	SUB8APW



SUB6A



MINISUB8



SUB8AL



SUB8AP



	SUB6A	MINISUB8A	SUB8AL	SUB8AP
Descrizione / Description	subwoofer amplificato / amplified subwoofer			
Woofer	6x9" ellittico / elliptical	20 cm	20 cm	1x20 cm high performance 1x20 cm passive
Potenza RMS / RMS Power Potenza musicale / Musical power	50W / 100W	100W / 200W	100W / 200W	300W dynamic
Massima pressione sonora Maximum sound pressure	105dB	104dB	105dB	108dB
Gamma utile / Useful range	45-200 Hz	20-160 Hz	20-160 Hz	25-200 Hz
Frequenza di crossover / Crossover frequency	60-200 Hz	40-160 Hz	40-160 Hz	40-200 Hz
Regolazione fase / Phase adjustment	da 0° a 180°	da 0° a 180°	da 0° a 180°	da 0° a 180°
Alimentazione / Power	220 Vca	120/240 Vca	120/240 Vca	120/240 Vca
Consumo / Consumption	100VA	120VA	120VA	120VA
Accensione/Auto Ignition/Auto	On/Off	On/Off	On/Off	On/Off
Dimensioni (LxHxP) / Size (WxHxD)	250x340x300 mm	267x280x305 mm	320x420x270 mm	267x280x305 mm
Peso / Weight	10 kg	8,2 kg	10,5 kg	8,5 kg
Cabinet	MDF impiallacciato / MDF veneer			
Colore / Color	bianco / white	bianco / white nero / black	nero / black	bianco / white nero / black
Temperatura di lavoro / Working temperature	da -20° a +65°	da -20° a +65°	da -20° a +65°	da -20° a +65



subwoofer amplificato da pavimento, elemento di arredo con finitura lucida
 floor-standing amplified subwoofer, piece of furniture with glossy finish

VIVALDI

RECOMMENDED FOR

EAN13

CODE



8051272187649	SUB8AB EOL
8051272187656	SUB8AW EOL
8051272186420	SUB10AB
8051272186437	SUB10AW
8051272187663	SUB12AB EOL
8051272187670	SUB12AW EOL
8051272181166	SMARTQUBEB
8051272186390	SMARTQUBEW



SUB8A



SUB10A



SUB12A



SMARTQUBE



	SUB8A	SUB10A	SUB12A	SMARTQUBE
Descrizione / Description	subwoofer amplificato / amplified subwoofer			subwoofer di potenza amplificato / amplified power subwoofer
Woofer	20 cm	25 cm	30 cm	32 cm
Potenza RMS / RMS Power Potenza musicale / Musical power	60W / 120W	150W / 300W	100W / 200W	300W / 600W
Massima pressione sonora Maximum sound pressure	104dB	110dB	109dB	118dB
Gamma utile / Useful range	40-150 Hz	40-200 Hz	40-150 Hz	35-200 Hz
Frequenza di crossover / Crossover frequency		50-200 Hz		50-200 Hz
Regolazione fase / Phase adjustment	da 0° a 180°	da 0° a 180°	da 0° a 180°	da 0° a 180°
Alimentazione / Power supply	115/230Vca auto switch	220 Vca	115/230Vca auto switch	220Vca
Consumo / Consumption	180VA	220VA	250VA	220VA
Accensione / Auto Ignition/Auto	On/Off	On/Off	On/Off	On/Off
Dimensioni (LxHxP) / Size (WxHxD)	265x344x275 mm	370x395x400 mm	355x444x368 mm	435x465x435 mm
Peso / Weight	7,8 kg	14,8 kg	11,7 kg	26 kg
Cabinet	MDF impiallacciato PVC PVC veneered MDF	MDF impiallacciato MDF veneer	MDF impiallacciato PVC PVC veneered MDF	MDF impiallacciato, antirisonante / MDF veneered, anti-resonant
Colore / Color	bianco / white nero / black	bianco / white nero / black	bianco / white nero / black	bianco opaco RAL9003 / white opaque nero opaco RAL9005 / black opaque
Temperatura di lavoro / Working temperature	da -20° a +65°	da -20° a +65°	da -20° a +65°	da -20° a +65°



Audio

High

Power



RECOMMENDED FOR **EAN13** **CODE**



8051272180237	SOUND8
8051272180244	SOUND8A
8051272180251	SOUND12
8051272180268	SOUND12A



	SOUND8	SOUND8A	SOUND12	SOUND12A
Descrizione / Description	Diffusore passivo a 2 vie Bass-Reflex 2 way passive speaker Bass-Reflex	Sistema 2 vie biamplificato in Bass-Reflex Bi-amplified 2 way system in Bass-Reflex	Diffusore passivo a 2 vie Bass-Reflex 2 way passive speaker Bass-Reflex	Sistema 2 vie biamplificato in Bass-Reflex Bi-amplified 2 way system in Bass-Reflex
Woofer	20cm (8") magnete ceramico / 20cm (8") ceramic magnet		32cm (12") magnete ceramico / 32cm (12") ceramic magnet	
Driver	a compressione con bocca da 25mm (1") e bobina da 32mm (1.5") compression with 25mm mouth (1") and 32mm coil (1.5")		a compressione con bocca da 25mm (1") e bobina da 44mm (2") compression with 25mm mouth (1") and 44mm coil (2")	
Pannello dei controlli Control Panel	---	Input, MIC, Line, XLR, Link Output	---	Input, MIC, Line, XLR, Link Output
Funzioni Functions	---	Level Mic e Level Line separate + Volume Generale Separate Mic Level and Line Level + Master Volume	---	Level Mic e Level Line separate + Volume Generale Separate Mic Level and Line Level + Master Volume
Controlli di tono / Tone control	---	Bassi, Alti / Bass, High	---	Bassi, Alti / Bass, High
Led	---	Clip Power	---	Clip Power
Tromba / Trumpet	90°H x 60°V	90°H x 60°V	90°H x 60°V	90°H x 60°V
Amplificatore LF/HF / LF/HF Amplifier	---	100W/25W RMS	---	150W/30W RMS
Potenza RMS / musicale RMS / Music Power	120W/200W	---	250W/400W	---
Impedenza / Tensione trasformatore Impedance / Transformer voltage	8Ω	attiva / active	8Ω	attiva / active
Risposta in frequenza / Sensibilità Frequency Response / Sensitivity	70Hz-18kHz -6dB / 95dB	70Hz-18kHz -6dB / 95dB	50Hz-18kHz -6dB / 98dB	50Hz-18kHz -6dB / 98dB
Maximum SPL/peak	116/119dB	116/119dB	120/123dB	120/123dB
Frequenza di Crossover Crossover Frequency	2.5KHz	2.5KHz	1.8KHz	1.8KHz
Connettori Connectors	IN power connettore speakon Linked (in dotazione) IN power connector speakon Linked (included)	IN XLR-JACK-PIN OUT XLR JACK	IN power connettore speakon Linked (in dotazione) IN power connector speakon Linked (included)	IN XLR-JACK-PIN OUT XLR JACK
Ingresso / Input	---	microfono XL/JACK mixabile Mixable XL/JACK microphone	---	---
Alimentazione / Power	---	240V/50-60Hz	---	240V/50-60Hz
Dimensioni (LxHxP) / Size (WxHxD)	265x410x240 mm	265x410x240 mm	400x640x330 mm	400x640x330 mm
Peso / Weight	5,6 kg	7,3 kg	17 kg	19,2 kg
Cabinet - Colore / Color	plastica / plastic antracite / anthracite	plastica / plastic antracite / anthracite	plastica / plastic antracite / anthracite	plastica / plastic antracite / anthracite

Note

4 punti di ancoraggio M8, foro per staffo da 35mm / 4 M8 anchor points, 35mm stand hole
Ancoraggio staffa per installazioni a parete / Bracket anchor for wall installations
1 maniglia integrata / 1 integrated handle



RECOMMENDED FOR	EAN13	CODE
	8051272180510	POWER10A
	8051272180527	POWER12A



	POWER10A	POWER12A
Descrizione / Description	Sistema 2 vie biamplificato CLASS-D Bass-Reflex Bi-amplified CLASS-D 2 way system in Bass-Reflex	
Applicazioni / Applications	Live Sound P.A., Monitor, D.J. System, Ristoranti, Pub, Club, Auditorium, Teatri, Palestre Live Sound P.A., Monitor, D.J. System, Restaurants, Pub, Club, Auditorium, Theatres, Gym	
Woofers	25cm (10") magnete ceramico progettato per alta efficienza e bassa distorsione 25cm (10") ceramic magnet designed for high efficiency and low distortion	32cm (12") magnete ceramico progettato per alta efficienza e bassa distorsione 32cm (12") ceramic magnet designed for high efficiency and low distortion
Driver	a compressione con bocca da 25mm (1") e bobina da 44mm (2") compression with 25mm (1") mouth and 44mm coil (2")	
Amplificatore LF/HF / LF/HF Amplifier	250W/70W RMS	500W/100W RMS
Amplificatori / Amplifier	equalizzati per ottimizzare la risposta in frequenza equalized to optimize frequency response	
Pannello dei controlli / Control Panel	Input, MIC, Line, XLR, Link Output	Input, MIC, Line, XLR, Link Output
Funzioni / Functions	Level Mic e Level Line separate + Volume Generale Separate Level Mic and Level Line + General Volume	
Controlli di tono / Tone control	Bassi, Alti / Bass, High	Bassi, Alti / Bass, High
Led	Clip Power, limite del compressore Clip Power, compressor limit	
Tromba / Trumpet	90°H x 60°V a direttività costante 90°H x 60°V at constant directivity	
Risposta in frequenza / Sensibilità / Frequency Response / Sensitivity	65Hz-18kHz -3dB 55Hz-20kHz -10dB 96dB	60Hz-18kHz -3dB 55Hz-20kHz -10dB 98dB
Maximum SPL/peak	123/126dB	125/128dB
Dispersione / Dispersion	90°x60° (HxV)	90°x60° (HxV)
Frequenza di Crossover / Crossover Frequency	2.2KHz	1.8KHz
IN/OUT	IN Connettore Combo XLR/JACK/ OUT Connettore XLR IN XLR/JACK/OUT Combo Connector XLR Connector	
Alimentazione / Power	switching AC 100-240V/50-60Hz	switching AC 100-240V/50-60Hz
Dimensioni (LxHxD) / Size (WxHxD)	335x545x320 mm	390x630x360 mm
Peso / Weight	16 kg	20 kg
Cabinet	plastica / plastic	plastica / plastic
Colore / Power	antracite / anthracite	antracite / anthracite
Note	5 punti di ancoraggio M10, foro per stativo da 35mm / 5 M10 anchor points, 35mm/ stand hole Ancoraggio staffa per installazioni a parete / Bracket anchor for wall installations 3 maniglie integrate / 3 integrated handles	



RECOMMENDED FOR

EAN13

CODE



8051272180305 **SUB15A**







SUB15A

Descrizione / Description	subwoofer amplificato professionale / professional amplified subwoofer
Applicazioni / Applications	pub, birrerie, sale conferenze, discolive, palestre, ... pubs, breweries, conference rooms, disco live, gyms, ...
Woofer	da 15" con bobina mobile da 2,5"/ 15" with 2.5" moving coil
Potenza / Power	400W (program) / 127dB SPL@1m (full power)
Gamma utile / Useful range	50-450Hz
Frequenza di crossover / Crossover frequency	80-250Hz
Connettori / Connectors	XLR/Jack
Dimensioni (LxHxD) / Size (WxHxD)	455x515x415 mm
Peso / Weight	38 kg
Cabinet	MDF con rinforzo interno, griglia nera di acciaio resistente a qualsiasi condizione climatica MDF with internal reinforcement, black grid of steel resistant to any climatic conditions
Finitura / Finishing	verniciata antigraffio / scratch-resistant paint
Colore / Color	nero / black
Temperatura di lavoro / Working temperature	da -20° a +65°
Note	2 maniglie / 2 handles





	EAN13	CODE	
	8051272180275	STANDWM	<p>IT - Supporto da parete, ancoraggio stabile, per SOUND8/8A, SOUND12/12A, POWER10A/12A. Dotato di braccio reclinabile e sistema di bloccaggio. Dimensioni 13,5x25x24 cm (LxHxP). Peso 1 Kg. Materiale metallo verniciato nero.</p> <p>EN - Wall Mount, Stable Anchor, for SOUND8/8A, SOUND12/12A, POWER10A/12A. Equipped with reclining arm and locking system. Size 13,5x25x24 cm (WxHxD). Weight 1 Kg. Black painted metal material.</p>
	8051272188837	SCWM8	<p>IT - Supporto a C, da parete, per diffusori SOUND8, SOUND8A.</p> <p>EN - In wall bracket for speakers SOUND8, SOUND8A.</p>
	8051272183290	SCWM12	<p>IT - Supporto a C, da parete, per diffusori SOUND12, SOUND12A, POWER10A, POWER12A.</p> <p>EN - In wall for speakers SOUND12, SOUND12A, POWER10A, POWER12A.</p>
	8051272186406	ST3	<p>IT - Supporto treppiede da pavimento, ancoraggio stabile, per: - SOUND8, SOUND8A, SOUND12, SOUND12A, POWER10A, POWER12A. - in abbinamento al SUCS per CS10T, CS20T, CS40, CS40T. Dotato di sistema di bloccaggio. Dimensioni (chiuso) 130x970x130 mm (LxHxP). Altezza aperto/max estensione 1940mm. Peso 2,7 Kg. Materiale metallo verniciato nero. Portata 30Kg max.</p> <p>EN - Floor tripod stand, stable anchorage, for: - SOUND8, SOUND8A, SOUND12, SOUND12A, POWER10A, POWER12A. - in combination with SUCS for CS10T, CS20T, CS40, CS40T. Equipped with locking system. Size (closed) 130x970x130 mm (WxHxD). Height open/max extension 1940mm. Weight 2,7 Kg. Black painted metal material. Capacity 30Kg max.</p>

Scatole da incasso per installazione a muratura Flush-mounting boxes for wall installation

	8051272181180	SR10	<p>IT - Scatola da incasso, rettangolare per installazioni sottotraccia del diffusore GIADA10, GIADA10T. Installazione a parete o soffitto. Struttura in metallo. Dimensioni (LxHxP) 155x210x75 mm. Peso 0,4 Kg. Colore grigio metallo. Particolarmente indicata per parti sottili (spessore max 10 cm).</p> <p>EN - Recessed box, rectangular for undertrack installations for speakers GIADA10, GIADA10T. In wall or ceiling installation. Metal frame. Size (WxHxD) 155x210x75 mm. Weight 0,4 Kg. Metal grey color. Particularly suitable for thin parts (max thickness 10 cm).</p>
	8051272181197	SR10ENX bianco / white	<p>IT - Copertura antifiama e anti umidità, rettangolare per installazioni a parete o soffitto del diffusore GIADA10T. Struttura in metallo. Dimensioni (LxHxP) 155x210x75 mm. Peso 0,4 Kg. Colore grigio metallo, verniciato bianco o nero. Attenzione: ordinare contestualmente al diffusore GIADA10T.</p> <p>EN - Flame retardant and anti-humidity cover, rectangular for wall or ceiling installations of GIADA10T speaker. Metal frame. Size (WxHxD) 155x210x75 mm. Weight 0,4 Kg. Metal grey color, painted white or black. Attention: order at the same time as GIADA10T speaker.</p>
	8051272189261	SR10ENXB nero / black	







EAN13		CODE
	8051272181173	SR1 <p>IT - Scatola da incasso, rettangolare per installazioni sottotraccia del diffusore GIADA13, GIADA13F, GIADA13L, GIADA13TF, GIADA13TL. Installazione a parete o soffitto. Struttura in metallo. Dimensioni (LxHxP) 210x255x90 mm. Peso 0,6 Kg. Colore grigio metallo.</p> <p>EN - Recessed box, rectangular for undertrack installations of speaker GIADA13, GIADA13F, GIADA13L, GIADA13TF, GIADA13TL. Wall or ceiling installation. Metal frame. Size (WxHxD) 210x255x90 mm. Weight 0,6 Kg. Metal grey color.</p>
	8051272181227	SR1S <p>IT - Scatola da incasso, rettangolare per installazioni sottotraccia del diffusore GIADA13, GIADA13L, GIADA13TL. Installazione a parete o soffitto. Struttura in metallo. Dimensioni (LxHxP) 200x250x75 mm. Peso 0,55 Kg. Colore grigio metallo.</p> <p>EN - Recessed box, rectangular for undertrack installations of speaker GIADA13, GIADA13L, GIADA13TL. Wall or ceiling installation. Metal frame. Size (WxHxD) 200x250x75 mm. Weight 0,55 Kg. Metal grey color.</p>
	8051272181234	SR2 <p>IT - Scatola da incasso, rettangolare per installazioni sottotraccia del diffusore GIADA16, GIADA16F, GIADA16TF, GIADA16TL, GIADA16HP, GIADA16HPA. Installazione a parete o soffitto. Struttura in metallo. Dimensioni (LxHxP) 220x305x90 mm. Peso 0,8 Kg. Colore grigio metallo.</p> <p>EN - Recessed box, rectangular for undertrack installations of speaker GIADA16, GIADA16F, GIADA16TF, GIADA16TL, GIADA16HP, GIADA16HPA. Wall or ceiling installation. Metal frame. Size (WxHxD) 220x305x90 mm. Weight 0,8 Kg. Metal grey color.</p>
	8051272186338	SC2 <p>IT - Scatola da incasso, rettangolare per installazioni sottotraccia del diffusore GIADA213F, . Installazione a parete o soffitto. Struttura in metallo. Dimensioni (LxHxP) 410x223x90 mm. Peso 0,8 Kg. Colore grigio metallo.</p> <p>EN - Recessed box, rectangular for undertrack installations of GIADA213F speaker, . Wall or ceiling installation. Metal frame. Size (WxHxD) 410x223x90 mm. Weight 0,8 Kg. Metal grey color.</p>
	8051272181265	SR3 <p>IT - Scatola da incasso, rettangolare per installazioni sottotraccia del diffusore GIADA213HP. Installazione a parete o soffitto. Struttura in metallo. Dimensioni (LxHxP) 260x340x90 mm. Peso 0,85 Kg. Colore grigio metallo.</p> <p>EN - Recessed box, rectangular for undertrack installations of GIADA213HP speaker. Wall or ceiling installation. Metal frame. Size (WxHxD) 260x340x90 mm. Weight 0,85 Kg. Metal grey color.</p>
	NEW 8051272181296	SR3PLUS <p>IT - Scatola da incasso, rettangolare per installazioni sottotraccia del diffusore GIADA20HP, GIADA20F, GIADA20TF, GIADA213HP, GIADA20SPF, GIADA20HPF. Installazione a parete o soffitto. Struttura in metallo. Dimensioni (LxHxP) 255x365x135 mm. Peso 1 Kg. Colore grigio metallo.</p> <p>EN - In-built case, rectangular for undertrack installation of the speakers GIADA20HP, GIADA20F, GIADA20TF, GIADA213HP, GIADA20SPF, GIADA20HPF. Installation in-wall or in-ceiling. Metal frame. Size (WxHxD) 255x365x135 mm. Weight 1 Kg. Metal grey colour.</p>



	EAN13	CODE		
	8051272181203	SR13	<p>IT - Scatola da incasso, rettangolare per installazioni sottotraccia del diffusore ROUND13L, ROUND13TL, ROUND13F, ROUND13TF. Installazione a parete o soffitto. Struttura in metallo. Dimensioni (LxHxP) 219x285x94 mm. Peso 0,9 Kg. Colore grigio metallo.</p>	<p>EN - Recessed box, rectangular for undertrack installations of speaker ROUND13L, ROUND13TL, ROUND13F, ROUND13TF. Wall or ceiling installation. Metal frame. Size (WxHxD) 219x285x94 mm. Weight 0,9 Kg. Metal grey color.</p>
	8051272181210	SR16	<p>IT - Scatola da incasso, rettangolare per installazioni sottotraccia del diffusore ROUND16L, ROUND16TL, ROUND16F, ROUND16TF. Installazione a parete o soffitto. Struttura in metallo. Dimensioni (LxHxP) 259x335x94 mm. Peso 1,1 Kg. Colore grigio metallo.</p>	<p>EN - Recessed box, rectangular for undertrack installations of speaker ROUND16L, ROUND16TL, ROUND16F, ROUND16TF. Wall or ceiling installation. Metal frame. Size (WxHxD) 259x335x94 mm. Weight 1,1 Kg. Metal grey color.</p>
	 8051272189957	SR20	<p>IT - Scatola da incasso, rettangolare per installazioni sottotraccia del subwoofer SUBGIADA20F, SUBGIADA20FA, SUBGIADA20SPF, SUBGIADA20SPFA. Installazione a parete o soffitto. Struttura in metallo. Dimensioni (LxHxP) 373x550x151 mm. Peso 1,3 Kg. Colore grigio metallo.</p>	<p>EN - Recessed box, rectangular for undertrack installations of SUBGIADA20F, SUBGIADA20FA, SUBGIADA20SPF, SUBGIADA20SPFA.. Wall or ceiling installation. Metal frame. Size (WxHxD) 373x550x151 mm. Weight 1,3 Kg. Metal grey color.</p>
	 8052015550287	SR30	<p>IT - Scatola da incasso, rettangolare per installazioni sottotraccia del subwoofer SUBROUND20SPF, SUBROUND20SPFA, SUBROUND20F, SUBROUND20FA. Installazione a parete o soffitto. Struttura in metallo. Dimensioni (LxHxP) 373x550x131 mm. Peso 1,3 Kg. Colore grigio metallo.</p>	<p>EN - Recessed box, rectangular for undertrack installations of SUBROUND20SPF, SUBROUND20SPFA, SUBROUND20F, SUBROUND20FA. Wall or ceiling installation. Metal frame. Size (WxHxD) 373x550x131 mm. Weight 1,3 Kg. Metal grey color.</p>
	8051272187076	SQR13	<p>IT - Scatola da incasso/calotta tagliafuoco, rettangolare per ROUND13TF. Dimensioni (LxHxP) 185x302x97mm. Peso 1,2 Kg. Colore grigio metallo.</p>	<p>EN - Recessed box/fire cap, rectangular for ROUND13TF. Size (WxHxD) 185x302x97mm. Weight 1,2 Kg. Metal grey color.</p>



	EAN13	CODE
	8051272187083	<p>SQR20</p> <p>IT - Scatola da incasso/calotta tagliafuoco ROUND20TF. Installazione a parete o soffitto. Struttura in metallo. Dimensioni (LxHxP) 263x352x104mm. Peso 1,7 Kg. Colore grigio metallo.</p> <p>EN - ROUND20TF recessed box/fire cap. Wall or ceiling installation. Metal frame. Size (WxHxD) 263x352x104mm. Weight 1,7 Kg. Metal grey color.</p>
	8051272181241	<p>SR2FC EOL</p> <p>IT - Accessori per l'installazione a filo cartongesso del diffusore Top Class GIADA16HP. Installazione a parete. Note: per la corretta finitura prima della rasatura è necessario acquistare il diffusore.</p> <p>EN - Accessories for installation flush with the plasterboard of the speaker Top Class GIADA16HP. Wall installation. For the correct finishing before shaving, it is necessary to purchase the speaker.</p>
	8051272181258	<p>SR2FM EOL</p> <p>IT - Accessori per l'installazione a filo muro del diffusore Top Class GIADA16HP. Installazione a parete. Note: per la corretta finitura prima della rasatura è necessario acquistare il diffusore.</p> <p>EN - Accessories for installation flush to the wall of the speaker Top Class GIADA16HP. Wall installation. For the correct finishing before shaving, it is necessary to purchase the speaker.</p>
	8051272181272	<p>SR3FC EOL</p> <p>IT - Accessori per l'installazione a filo cartongesso dei diffusori Top Class GIADA20HP, GIADA213HP. Installazione a parete. Note: per la corretta finitura prima della rasatura è necessario acquistare il diffusore.</p> <p>EN - Accessories for the installation flush plasterboard of Top Class GIADA20HP, GIADA213HP speakers. Wall installation. Notes: for the correct finishing before shaving it is necessary to purchase speaker.speaker.</p>
	8051272181289	<p>SR3FM EOL</p> <p>IT - Accessori per l'installazione a filo muro dei diffusori Top Class GIADA20HP, GIADA213HP. Installazione a parete. Note: per la corretta finitura prima della rasatura è necessario acquistare il diffusore.</p> <p>EN - Accessories for installation flush to the wall of the speakers Top Class GIADA213. Wall installation. For the correct finishing before shaving, it is necessary to purchase the speaker.</p>





diffusori da esterno HiFi di design in acciaio 316L
HiFi design outdoor speakers in 316L steel

VIVALDI

RECOMMENDED FOR	EAN13	CODE
-----------------	-------	------



IP65	8051272186871	ZEN315
IP65	8051272188455	ZEN315T
IP65	8051272186895	ZEN510
IP65	8051272188479	ZEN510T



	ZEN315	ZEN315T	ZEN510	ZEN510T
Descrizione / Description	Diffusore di design, HiFi, 2 vie / Design speaker, HiFi, 2 way			
Grado di protezione / Protection degree	IP65	IP65	IP65	IP65
Tipologia / Typology	audio	audio	audio + luce / audio + light	audio + luce / audio + light
Applicazioni / Applications	terrazze, giardini, piscine... / terraces, gardens, swimming pools...			
Led	---	---	66 Led, 13,8W, 1380lm, 3800K	66 Led, 13,8W, 1380lm, 3800K
Woofers	16,5 cm	16,5 cm	16,5 cm	16,5 cm
Tweeter	2,5 cm	2,5 cm	2,5 cm	2,5 cm
Potenza RMS / musicale RMS / Music Power	50W/100W	---	50W/100W	---
Potenza nominale / peak Nominal power / peak	---	50W/100W	---	50W/100W
Impedenza / Tensione trasformatore Impedance / Transformer voltage	8Ω	100V	8Ω	100V
Risposta in frequenza / Sensibilità Frequency Response / Sensitivity	60-20000Hz/89dB	60-20000Hz/89dB	60-20000Hz/89dB	60-20000Hz/89dB
Dimensioni (DxH) / Size (DxH)	205x315 mm	205x315 mm	205x510 mm	205x510 mm
Flangia di ancoraggio (D) Anchor flange (D)	30 cm	30 cm	30 cm	30 cm
Peso / Weight	7,0 kg	7,0 kg	8,2 kg	8,2 kg
Colore / Color	acciaio spazzolato brushed steel	acciaio spazzolato brushed steel	acciaio spazzolato brushed steel	acciaio spazzolato brushed steel
Cabinet	acciaio Inox 316L stainless steel 316L	acciaio Inox 316L stainless steel 316L	acciaio Inox 316L stainless steel 316L	acciaio Inox 316L stainless steel 316L
Personalizzazione / Customization	colore su richiesta color on request	colore su richiesta color on request	colore su richiesta color on request	colore su richiesta color on request



RECOMMENDED FOR



EAN13

CODE

IP65	8051272186901	ZEN730
IP65	8051272188462	ZEN730T
IP65	8051272186925	ZEN780
IP65	8051272188493	ZEN780A



esempio di personalizzazione
nero opaco RAL 9005
example of customization
black matt RAL 9005

	ZEN730	ZEN730T	ZEN780	ZEN780A
Descrizione / Description	Diffusore di design, HiFi, 2 vie / Design speaker, HiFi, 2 way		Diffusore di design, HiFi, 3 vie / Design speaker, HiFi, 3 way	
Grado di protezione / Protection degree	IP65	IP65	IP65	IP65
Tipologia / Typology	audio	audio	audio + subwoofer	audio + subwoofer
Applicazioni / Applications	terrazze, giardini, piscine... / terraces, gardens, swimming pools...			
Subwoofer	---	---	2x16,5 cm push-pull	2x16,5 cm push-pull
Woofers	16,5 cm	16,5 cm	16,5 cm	16,5 cm
Tweeter	2,5 cm compressione 2,5 cm compression	2,5 cm compressione 2,5 cm compression	3,4 cm compressione 3,4 cm compression	3,4 cm compressione 3,4 cm compression
Potenza RMS / musicale RMS / Music Power	100/200W	---	300/600W	---
Potenza nominale / peak Nominal power / peak	---	50/100W	---	---
Potenza / power woofer RMS Potenza / power medio RMS Potenza / power tweeter RMS	---	---	---	300W 150W 150W
Impedenza / Tensione trasformatore Impedance / Transformer voltage	8Ω	100V	4Ω	attivo / active
Risposta in frequenza / Sensibilità Frequency Response / Sensitivity	60-20000Hz / 90dB	60-20000Hz / 90dB	40-20000Hz / 91dB	40-20000Hz / 1V RMS
Max output level full power	---	---	114dB	114dB
Alimentazione / Power supply	---	---	---	220V/50-60Hz
Dimensioni (DxH) / Size (DxH)	205x725 mm	205x725 mm	205x995 mm	205x995 mm
Flangia di ancoraggio (D) Anchor flange (D)	30 cm	30 cm	30 cm	30 cm
Peso / Weight	12,5 kg	12,5 kg	19,5 kg	19,5 kg
Colore / Color	acciaio spazzolato brushed steel	acciaio spazzolato brushed steel	acciaio spazzolato brushed steel	acciaio spazzolato brushed steel
Cabinet	acciaio Inox 316L spazzolato stainless steel 316L	acciaio Inox 316L spazzolato stainless steel 316L	acciaio Inox 316L spazzolato stainless steel 316L	acciaio Inox 316L spazzolato stainless steel 316L
Personalizzazione / Customization	colore su richiesta color on request	colore su richiesta color on request	colore su richiesta color on request	colore su richiesta color on request



diffusori da esterno HiFi di design in acciaio 316L
HiFi design outdoor speakers in 316L steel

VIVALDI

EAN13	CODE
IP65 8051272186932	ZEN930
IP65 8051272188486	ZEN930T
IP65 8051272186949	ZEN980
IP65 8051272188509	ZEN980A
 IP65 8051272189902	SUPERZEN

RECOMMENDED FOR



esempio di personalizzazione
nero opaco RAL 9005
example of customization
black matt RAL 9005



	ZEN930	ZEN930T	ZEN980	ZEN980A	SUPERZEN
Descrizione / Description	Diffusore di design, HiFi, 2 vie Design speaker, HiFi, 2 way	Diffusore di design, HiFi, 2 vie Design speaker, HiFi, 2 way	Diffusore di design, HiFi, 3 vie Design speaker, HiFi, 3 way	Diffusore di design, HiFi, 3 vie con DSP Design speaker, HiFi, 3 way with DSP	Diffusore di design, HiFi, 3 vie con DSP Design speaker, HiFi, 3 way with DSP
Grado di protezione / Protection degree	IP65	IP65	IP65	IP65	IP65
Tipologia / Typology	audio + luce / audio + light		audio + subwoofer + luce (light)		audio + subwoofer
Applicazioni / Applications	terrazze, giardini, piscine... / terraces, gardens, swimming pools...				
Led	66 Led, 13,8W, 1380lm, 3800K		66 Led, 13,8W, 1380lm, 3800K		---
Subwoofer	---	---	2x16,5 cm push-pull	2x16,5 cm push-pull	2x26,5 cm push-pull
Woofer	16,5 cm	16,5 cm	16,5 cm	16,5 cm	26,8 cm
Tweeter	2,5 cm compressione compression	2,5 cm compressione compression	3,4 cm compressione compression	3,4 cm compressione compression	4,4 cm compressione compression
Potenza RMS / musicale RMS / Music Power	100/200W	---	300/600W	---	3000/6000W
Potenza nominale / peak Nominal power / peak	---	50W 100W peak	---	---	---
Potenza / power woofer RMS Potenza / power medio RMS Potenza / power tweeter RMS	---	---	---	300W 150W 150W	2000W 600W 100W
Impedenza / Tensione trasformatore Impedance / Transformer voltage	8Ω	100V	4Ω	attivo / active	attivo / active
Risposta in frequenza / Sensibilità Frequency Response / Sensitivity	60-20000Hz / 90dB	60-20000Hz / 90dB	40-20000Hz / 91dB	40-20000Hz 1V RMS	40-20000Hz 1V RMS
Max output level full power	---	---	114dB	114dB	126dB
Alimentazione / Power supply	---	---	---	220V/50-60Hz	220V/50-60Hz
Dimensioni (DxH) / Size (DxH)	205x938 mm	205x938 mm	205x1200 mm	205x1200 mm	306x1220 mm
Flangia di ancoraggio / Anchor flange (D)	30 cm	30 cm	30 cm	30 cm	40 cm
Peso / Weight	14,2 kg	14,2 kg	20 kg	20 kg	46 kg
Colore / Color	acciaio spazzolato brushed steel	acciaio spazzolato brushed steel	acciaio spazzolato brushed steel	acciaio spazzolato brushed steel	acciaio spazzolato brushed steel
Cabinet	acciaio Inox 316L stainless steel 316L	acciaio Inox 316L stainless steel 316L	acciaio Inox 316L stainless steel 316L	acciaio Inox 316L stainless steel 316L	acciaio Inox 316L stainless steel 316L
Personalizzazione / Customization	colore su richiesta color on request	colore su richiesta color on request	colore su richiesta color on request	colore su richiesta color on request	colore su richiesta color on request



RECOMMENDED FOR

EAN13

CODE



IP65	8051272186888	ZEN315L
IP65	8051272186918	ZEN730L



	ZEN315L	ZEN730L
Descrizione / Description	Lampada di design con illuminazione a LED per esterni / design lamp with outdoor LED lighting	
Grado di protezione / Protection degree	IP65	IP65
Applicazioni / Applications	terrazze, giardini, piscine... / terraces, gardens, swimming pools...	
Tecnologia / Technology	LED	LED
Punti led / LED points	66	66
Watt	13,8	13,8
Lumen	1380	1380
Temperatura / Temperature	3800K	3800K
Alimentazione / Power supply	240Vca	240Vca
Dispersione / Dispersion	360°	360°
Dimensioni (DxH) / Size (DxH)	205x315 mm	205x730 mm
Flangia di ancoraggio / Anchor flange (D)	30 cm	30 cm
Peso / Weight	4,0 kg	7,0 kg
Colore / Color	opalino / opaline	opalino / opaline
Personalizzazione / Customization	è possibile personalizzare il colore dei LED ed integrarne la gestione da iCONTROL4.1L, iCONTROL4.0+ it is possible to customize the color of the LEDs and integrate their management from iCONTROL4.1L, iCONTROL4.0+	



RECOMMENDED FOR

EAN13

CODE



IP56	8051272188554	ROCK20T
IP56	8051272184013	GREEN16T



	ROCK20T	GREEN16T
Descrizione / Description	Diffusore 2 vie coax, HiFi, da giardino waterproof / 2 way coax speaker, HiFi, waterproof garden	
Grado di protezione / Protection degree	IP56	IP56
Woofer	20 cm in polipropilene 20 cm polypropylene	16,5 cm in polipropilene 16.5 cm polypropylene
Tweeter	2,5 cm in titanio con magnete al neodimio 2,5 cm in titanium with neodymium magnet	3 cm in titanio magnete al neodimio 3 cm in titanium with neodymium magnet
Potenza RMS / musicale RMS / Music Power	75/150W	60/120W
Potenza nominale 100V / peak Nominal power 100V / peak	2/4/8/16/32W 64 peak, max 106dB	2/4/8/16/32W 64 peak, max 105dB
Potenza nominale 70V / peak Nominal power 70V / peak	2/4/8/16/32W 64W peak	2/4/8/16/32W 64W peak
Impedenza / Tensione trasformatore Impedance / Transformer voltage	8Ω/70V/100V	8Ω/70V/100V
Amplificazione consigliata Recommended amplification	da 10 a 100W RMS 10 to 100W RMS	da 10 a 100W RMS 10 to 100W RMS
Risposta in frequenza / Sensibilità Frequency Response / Sensitivity	50-20000Hz/91dB max 106dB	55-20000Hz/90dB max 105dB
Angolo di dispersione / Dispersion angle	120°(O)x120°(V)	360°(O)x40°(V)
Dimensioni Size	(LxHxP) 440x300x300 mm (WxHxD) 440x300x300 mm	(DxP) 365x409 mm (DxD) 365x409 mm
Peso / Weight	7,0 kg	3,0 kg
Colore / Color	grigio simil roccia / rock-like grey	verde / green
Cabinet	fibra di vetro verniciata / painted fiberglass	polipropilene UV / UV polypropylene





Hand Made Speakers



EAN13 **CODE**

8051272184501	KEOPE.S40
8051272184518	KEOPE.S80
8051272184495	KEOPE.S160

RECOMMENDED FOR



	KEOPE.S40	KEOPE.S80	KEOPE.S160
Descrizione / Description	Diffusore TOP QUALITY, di design, 2 vie, da appoggio / TOP QUALITY speaker, design, 2 way, bookshelf		
Applicazioni Applications	Ideale per sale cineconferenze, congressi, HiFi, Home Cinema e diffusionsi sonore Ideal for cine conference rooms, congresses, HiFi, Home Cinema and sound diffusion		
Woofers	9 cm	2x9 cm	4x9 cm
Tweeter	2,5 cm	2,5 cm	2,5 cm
Potenza RMS / musicale RMS / Music Power	45W/90W	85W/170W	165W/330W
Impedenza / Impedance	8Ω	4Ω	8Ω
Risposta in frequenza / Sensibilità Frequency Response / Sensitivity	85-20000Hz +5dB/86dB	85-20000Hz +5dB/89dB	85-20000Hz +5dB/92dB
Dimensioni (LxHxD) / Size (WxHxD)	110x235x130 mm	110x450x130 mm	110x1110x130 mm
Peso / Weight	2,4 kg	3,5 kg	7,5 kg
Cabinet	legno / wood	legno / wood	legno / wood
Finiture / Finishing	alluminio spazzolato brushed aluminium	alluminio spazzolato brushed aluminium	alluminio spazzolato brushed aluminium
Supporto / Support	supporto per il fissaggio a parete, fornito in dotazione / support for wall mounting, included		
Calza colore di serie / Sock color as standard	nero / black	nero / black	nero / black
Colori calze Socks colors	<ul style="list-style-type: none"> - bianco / white (K40W) - grigio / grey (K40G) - antracite / anthracite (K40A) - sabbia / sand (K40S) - ruggine / rust (K40R) - rosso ciliegia / red cherry (K40C) - glicine / wisteria (K40V) - blu ceruleo / cerulean blue (K40B) - verde / green (K40E) 	<ul style="list-style-type: none"> - bianco / white (K80W) - grigio / grey (K80G) - antracite / anthracite (K80A) - sabbia / sand (K80S) - ruggine / rust (K80R) - rosso ciliegia / red cherry (K80C) - glicine / wisteria (K80V) - blu ceruleo / cerulean blue (K80B) - verde / green (K80E) 	<ul style="list-style-type: none"> - bianco / white (K160W) - grigio / grey (K160G) - antracite / anthracite (K160A) - sabbia / sand (K160S) - ruggine / rust (K160R) - rosso ciliegia / red cherry (K160C) - glicine / wisteria (K160V) - blu ceruleo / cerulean blue (K160B) - verde / green (K160E)



EAN13	CODE
-------	------

8051272184471	KEOPE.HP60
8051272184464	KEOPE.HP120
8051272184488	KEOPE.M250 (monitor)

RECOMMENDED FOR



	KEOPE.HP60	KEOPE.HP120	KEOPE.M250 (monitor)
Descrizione / Description	Diffusore TOP DI GAMMA, di design, 2 vie, da appoggio / FLAGSHIP speaker, design, 2 way, bookshelf		
Applicazioni Applications	Ideale per Sale Cineconferenze, congressi, HiFi, Home Cinema, diffusioni sonore, PUB, Birrerie ideal for Cine conference room, congress, HiFi, Home Cinema, sound diffusion, PUB, Brewerie		
Woofer	13 cm	2x13 cm	2x15 cm
Tweeter	2,5 cm	2,5 cm	2,5 cm
Potenza RMS / musicale RMS / Music Power	70W/140W	120W/240W	240W/480W
Impedenza / Impedance	8Ω	4Ω	4Ω
Risposta in frequenza / Sensibilità Frequency Response / Sensitivity	65-20000Hz +-5dB/89dB	65-20000Hz +-5dB/92dB	45-20000Hz +-5dB/90dB
Dimensioni (LxHxD) / Size (WxHxD)	172x275x210 mm	172x515x210 mm	172x1015x210 mm
Peso / Weight	6,0 kg	8,5 kg	13 kg
Cabinet	legno / wood	legno / wood	legno / wood
Finiture	alluminio spazzolato brushed aluminium	alluminio spazzolato brushed aluminium	alluminio spazzolato brushed aluminium
Supporto / Support	supporto per il fissaggio a parete, fornito in dotazione / support for wall mounting, included		
Calza colore di serie / Sock color as standard	nero / black	nero / black	nero / black
Colori calze	<ul style="list-style-type: none"> - bianco / white (KHP60W) - grigio / grey (KHP60G) - antracite / anthracite (KHP60A) - sabbia / sand (KHP60S) - ruggine / rust (KHP60R) - rosso ciliegia / red cherry (KHP60C) - glicine / wisteria (KHP60V) - blu ceruleo / cerulean blue (KHP60B) - verde / green (KHP60E) 	<ul style="list-style-type: none"> - bianco / white (KHP120W) - grigio / grey (KHP120G) - antracite / anthracite (KHP120A) - sabbia / sand (KHP120S) - ruggine / rust (KHP120R) - rosso ciliegia / red cherry (KHP120C) - glicine / wisteria (KHP120V) - blu ceruleo / cerulean blue (KHP120B) - verde / green (KHP120E) 	<ul style="list-style-type: none"> - bianco / white (KM250W) - grigio / grey (KM250G) - antracite / anthracite (KM250A) - sabbia / sand (KM250S) - ruggine / rust (KM250R) - rosso ciliegia / red cherry (KM250C) - glicine / wisteria (KM250V) - blu ceruleo / cerulean blue (KM250B) - verde / green (KM250E)



RECOMMENDED FOR



EAN13

CODE

8051272184532	KEOPE.SOUNDB80
8051272184525	KEOPE.SOUNDB160



KEOPE.SOUNDB80



KEOPE.SOUNDB160

	KEOPE.SOUNDB80	KEOPE.SOUNDB160
Descrizione / Description	Soundbar stereo, di design, da appoggio / Stereo soundbar, design, bookshelf	
Applicazioni / Applications	Ideale per sistemi 2.1 in abbinamento ai subwoofer attivi SUB8A, SUB12A Ideal for 2.1 systems in combination with SUB8A, SUB12A active subwoofers	
Woofers	2x9 cm	4x9 cm
Tweeter	2x2,5 cm	2x2,5 cm
Potenza RMS / musicale RMS / Music Power	45+45W/90+90W	85+85W/170+170W
Impedenza / Impedance	8Ω	4Ω
Risposta in frequenza / Sensibilità Frequency Response / Sensitivity	85-20000Hz +-5dB/89dB	85-20000Hz +-5dB/92dB
Dimensioni (LxHxD) Size (WxHxD)	615x110x130 mm	915x110x130 mm
Peso / Weight	2,4 kg	6,8 kg
Cabinet	legno / wood	legno / wood
Finiture / Finishing	alluminio spazzolato / brushed aluminium	alluminio spazzolato / brushed aluminium
Supporto / Support	supporto per il fissaggio a parete, fornito in dotazione / support for wall mounting, included	
Calza colore di serie / Sock color as standard	nero / black	nero / black
Colori calze	<ul style="list-style-type: none"> - bianco / white (KSB80W) - grigio / grey (KSB80G) - antracite / anthracite (KSB80A) - sabbia / sand (KSB80S) - ruggine / rust (KSB80R) - rosso ciliegia / red cherry (KSB80C) - glicine / wisteria (KSB80V) - blu ceruleo / cerulean blue (KSB80B) - verde / green (KSB80E) 	<ul style="list-style-type: none"> - bianco / white (KSB160W) - grigio / grey (KSB160G) - antracite / anthracite (KSB160A) - sabbia / sand (KSB160S) - ruggine / rust (KSB160R) - rosso ciliegia / red cherry (KSB160C) - glicine / wisteria (KSB160V) - blu ceruleo / cerulean blue (KSB160B) - verde / green (KSB160E)



EAN13	CODE
-------	------



8051272189339 **WB1**

IT - Supporto universale da parete.
Inclinazione 120°V / 180°O.
Portata 15Kg. Materiale lega di zinco, verniciato.
Dimensioni (LxHxP) 9,5x11,5x5 cm.
Peso 0,3Kg. Colore nero.

EN - Universal wall mount. Inclination 120°V / 180°W.
Capacity 15Kg. Zinc alloy material, painted.
Size (WxHxD) 9,5x11,5x5 cm.
Weight 0,3Kg. Black color.



8051272189612 **WB2**

IT - Supporto universale da parete.
Inclinazione 30°V / 160°O.
Portata 35Kg.
Materiale acciaio, verniciato.
Dimensioni (LxHxP) 6x12,5x12,5 cm.
Peso 0,4Kg. Colore nero.

EN - Universal wall mount. Inclination 30°V / 160°W.
Capacity 35Kg.
Steel material, painted.
Size (WxHxD) 6x12,5x12,5 cm.
Weight 0,4Kg. Black color.



8051272189629 **WB3**

IT - Supporto universale da parete.
Inclinazione 120°V / 180°O.
Portata 60Kg.
Materiale acciaio, verniciato.
Dimensioni (LxHxP) 9x16x10 cm.
Peso 0,45Kg. Colore nero.

EN - Universal wall mount. Inclination 120°V / 180°W.
Capacity 60Kg.
Steel material, painted.
Size (WxHxD) 9x16x10 cm.
Weight 0,45Kg. Black color.

Colori calze
Socks colors

BLU CERULEO / CERULEAN BLUE



8051272184297 **K40B** per KEOPE.S40

8051272184389 **K80B** per KEOPE.S80

8051272184204 **K160B** per KEOPE.S160

8051272184945 **KSB80B** per KEOPE.SOUNDB80

8051272184853 **KSB160B** per KEOPE.SOUNDB160

8051272184679 **KHP60B** per KEOPE.HP60

8051272184587 **KHP120B** per KEOPE.HP120

8051272184761 **KM250B** per KEOPE.M250

SABBIA / SAND



8051272184341 **K40S** per KEOPE.S40

8051272184433 **K80S** per KEOPE.S80

8051272184259 **K160S** per KEOPE.S160

8051272184990 **KSB80S** per KEOPE.SOUNDB80

8051272184907 **KSB160S** per KEOPE.SOUNDB160

8051272184723 **KHP60S** per KEOPE.HP60

8051272184631 **KHP120S** per KEOPE.HP120

8051272184815 **KM250S** per KEOPE.M250



	EAN13	CODE
ANTRACITE / ANTHRACITE		
	8051272184280	K40A per KEOPE.S40
	8051272184372	K80A per KEOPE.S80
	8051272184198	K160A per KEOPE.S160
	8051272184938	KSB80A per KEOPE.SOUNDB80
	8051272184846	KSB160A per KEOPE.SOUNDB160
	8051272184662	KHP60A per KEOPE.HP60
	8051272184570	KHP120A per KEOPE.HP120
	8051272184754	KM250A per KEOPE.M250
GRIGIO / GREY		
	8051272184327	K40G per KEOPE.S40
	8051272184419	K80G per KEOPE.S80
	8051272184235	K160G per KEOPE.S160
	8051272184976	KSB80G per KEOPE.SOUNDB80
	8051272184884	KSB160G per KEOPE.SOUNDB160
	8051272184709	KHP60G per KEOPE.HP60
	8051272184617	KHP120G per KEOPE.HP120
	8051272184792	KM250G per KEOPE.M250
VERDE / GREEN		
	8051272184310	K40E per KEOPE.S40
	8051272184402	K80E per KEOPE.S80
	8051272184228	K160E per KEOPE.S160
	8051272184969	KSB80E per KEOPE.SOUNDB80
	8051272184877	KSB160E per KEOPE.SOUNDB160
	8051272184693	KHP60E per KEOPE.HP60
	8051272184600	KHP120E per KEOPE.HP120
	8051272184785	KM250E per KEOPE.M250
RUGGINE / RUST		
	8051272184334	K40R per KEOPE.S40
	8051272184426	K80R per KEOPE.S80
	8051272184242	K160R per KEOPE.S160
	8051272184983	KSB80R per KEOPE.SOUNDB80
	8051272184891	KSB160R per KEOPE.SOUNDB160
	8051272184716	KHP60R per KEOPE.HP60
	8051272184624	KHP120R per KEOPE.HP120
	8051272184808	KM250R per KEOPE.M250



	EAN13	CODE
GLICINE / WISTERIA		
	8051272184358	K40V per KEOPE.S40
	8051272184440	K80V per KEOPE.S80
	8051272184266	K160V per KEOPE.S160
	8051272185003	KSB80V per KEOPE.SOUNDB80
	8051272184914	KSB160V per KEOPE.SOUNDB160
	8051272184730	KHP60V per KEOPE.HP60
	8051272184648	KHP120V per KEOPE.HP120
	8051272184822	KM250V per KEOPE.M250
BIANCO / WHITE		
	8051272184365	K40W per KEOPE.S40
	8051272184457	K80W per KEOPE.S80
	8051272184273	K160W per KEOPE.S160
	8051272185010	KSB80W per KEOPE.SOUNDB80
	8051272184921	KSB160W per KEOPE.SOUNDB160
	8051272184747	KHP60W per KEOPE.HP60
	8051272184655	KHP120W per KEOPE.HP120
	8051272184839	KM250W per KEOPE.M250
ROSSO CILIEGIA / RED CHERRY		
	8051272184303	K40C per KEOPE.S40
	8051272184396	K80C per KEOPE.S80
	8051272184211	K160C per KEOPE.S160
	8051272184952	KSB80C per KEOPE.SOUNDB80
	8051272184860	KSB160C per KEOPE.SOUNDB160
	8051272184686	KHP60C per KEOPE.HP60
	8051272184594	KHP120C per KEOPE.HP120
	8051272184778	KM250C per KEOPE.M250





RECOMMENDED FOR



EAN13

CODE

8051272185980	QTOWER1
8051272185997	QTOWER2
8051272186000	QTOWER2C canale centrale

QTOWER1



	QTOWER1	QTOWER2/2C
Descrizione / Description	<p>Diffusore di design, 100% Made In Italy dalle forme antirisonanti Sistema a 2 vie ideale per riproduzioni HiFi stereo oppure come canale centrale, frontale, posteriore nei sistemi Home Cinema.</p> <p>Design speaker, 100% Made in Italy with anti-resonant shapes 2 way system ideal for stereo HiFi reproductions or as center, front, rear channel in Home Cinema systems.</p>	
Tweeter	<p>a cupola da 25 mm di alta qualità in seta trattata antirisonante circuito magnetico di alta potenza al neodimio con dissipatore termico ad elevate prestazioni</p> <p>High Quality 25mm Dome Made of Anti-Resonant Treated Silk High Power Neodymium Magnetic Circuit with High Performance Heat Sink</p>	
Mid-bass	1 XTDD da 13,5 cm / 1 XTDD to 13,5 cm	2 XTDD da 13,5 cm / 2 XTDD to 13,5 cm
Potenza RMS / musicale RMS / Music Power	70W/140W	140W/280W
Impedenza / Impedance	8Ω	4Ω
Risposta in frequenza / Sensibilità Frequency Response / Sensitivity	75-22000Hz/89dB	70-22000Hz/92dB
Amplificazione consigliata Recommended amplification	da 30 a 80W RMS	da 30 a 150W RMS
Dimensioni (LxHxP) / Size (WxHxD)	160x320x145 mm	160x920x145 mm
Peso / Weight	5,1 kg	12 kg
Struttura / Structure	alluminio estruso da 4mm / 4mm extruded aluminum	alluminio estruso da 4mm / 4mm extruded aluminum
Finiture / Finishing	alluminio spazzolato / brushed aluminium	alluminio spazzolato / brushed aluminium
Retina	rivestita in tela / covered in canvas	rivestita in tela / covered in canvas
Finiture personalizzabili Customizable finishing	colore e rivestimenti scocca, frontali e retina (quotazione a parte) color and coatings body, front and retina (quotation apart)	
Installazione / Installation	installazione verticale o orizzontale, appoggio su pavimento, mobile o mensola vertical or horizontal installation, support on the floor, cabinet or shelf	
Accessori da ordinare a parte Accessories not included	<p>- supporto da parete, rotazione fino a 160° e inclinazione fino a +/- 10°, QTowerSO Attenzione: di serie, il cabinet dei diffusori QTower, non ha i fori per il supporto. Pertanto indicare in fase d'ordine se si desidera installare la QTower a parete al fine di effettuare una corretta produzione.</p> <p>- base da pavimento (progetto, materiale e quotazione on demand) - wall mount, rotation up to 160° and inclination up to +/- 10°, QTowerSO Attention: as standard, the QTower speaker cabinet does not have holes for support. Therefore indicate when ordering if you want to install the QTower on the wall in order to carry out a correct production.</p> <p>- floor base (design, material and on-demand quotation)</p>	



diffusori HiFi in acciaio e legno
HiFi speakers in steel and wood

VIVALDI



QTOWER2

BASE DA PAVIMENTO PERSONALIZZABILE
(progetto e materiale) quotazione su richiesta

CUSTOMIZABLE FLOOR BASE
(project and material) quotation on demand



QTOWER2C





RECOMMENDED FOR	EAN13	CODE
	8051272181159	QTOWER4
	8051272186017	QTOWER4C
	8051272186024	QTOWER4PRO
	8051272186031	QTOWER4PROA

	QTOWER4/4C	QTOWER4PRO	QTOWER4PROA
Descrizione / Description	<p>Diffusore di design, 100% Made In Italy dalle forme antirisonanti</p> <p>Sistema a 2 vie ideale per riproduzioni HiFi stereo oppure come canale centrale, frontale, posteriore nei sistemi Home Cinema.</p> <p>Design speaker, 100% Made in Italy with anti-resonant shapes</p> <p>2 way system ideal for stereo HiFi playback or as center, front, rear channel in Home Cinema systems.</p>	<p>Diffusore di design, 100% Made In Italy dalle forme antirisonanti</p> <p>Sistema a 2 vie per applicazioni professionali a media gittata (sale conferenze, auditorium, hotel, discolve...)</p> <p>Design speaker, 100% Made in Italy with anti-resonant shapes</p> <p>2 way system for medium-range professional applications (conference rooms, auditoriums, hotels, discos...)</p>	
Tweeter	<p>a cupola da 25 mm di alta qualità in seta trattata antirisonante circuito magnetico di alta potenza al neodimio con dissipatore termico ad elevate prestazioni</p> <p>High Quality 25mm Dome Made of Anti-Resonant Treated Silk High Power Neodymium Magnetic Circuit with High Performance HeatSink</p>	<p>neodimio da 25 mm a compressione, alta efficienza, caricato su tromba esponenziale 80° di dispersione</p> <p>compression 25 mm neodymium, high efficiency, loaded on exponential horn 80° of dispersion</p>	
Mid-bass	<p>4 XTDD da 13,5 cm</p> <p>4 XTDD to 13,5 cm</p>	<p>4 XTDD da 13,5 cm con rifasatore</p> <p>4 XTDD to 13,5 cm with phase plug for woofer</p>	<p>4 XTDD da 13,5 cm</p> <p>4 XTDD to 13,5 cm</p>
Potenza RMS / musicale RMS / Music Power	250W/500W	250W/500W	---
Impedenza / Impedance	8Ω	8Ω	ATTIVA biamplificato powersoft 380W+100W RMS ACTIVE bi-amplified powersoft 380W+100W RMS
Risposta in frequenza / Sensibilità Frequency Response / Sensitivity	70-22000Hz/95dB	65-20000Hz/95dB	65-20000Hz
Max Output Level	---	---	120dB - peak 123dB
Amplificazione consigliata Recommended amplification	da 80 a 250W RMS	da 80 a 250W RMS	---
Dimensioni (LxHxP) / Size (WxHxD)	160x1220x145 mm	160x1220x145 mm	160x1220x145 mm
Peso / Weight	18 kg	18 kg	19,5 kg
Struttura / Structure	alluminio estruso da 4mm 4mm extruded aluminum	alluminio estruso da 4mm 4mm extruded aluminum	alluminio estruso da 4mm 4mm extruded aluminum
Finiture / Finishing	alluminio spazzolato brushed aluminium	alluminio spazzolato brushed aluminium	alluminio spazzolato brushed aluminium
Retina	rivestita in tela / covered in canvas	rivestita in tela / covered in canvas	rivestita in tela / covered in canvas
Finiture personalizzabili Customizable finishing	colore e rivestimenti scocca, frontali e retina (quotazione a parte) color and coatings body, front and retina (quotation apart)	colore e rivestimenti scocca, frontali e retina (quotazione a parte) color and coatings body, front and retina (quotation apart)	colore e rivestimenti scocca, frontali e retina (quotazione a parte) color and coatings body, front and retina (quotation apart)
Installazione / Installation	installazione verticale o orizzontale, appoggio su pavimento, mobile o mensola vertical or horizontal installation, support on the floor, cabinet or shelf	installazione verticale, appoggio su pavimento, mobile o mensola vertical installation, support on the floor, cabinet or shelf	installazione verticale, appoggio su pavimento, mobile o mensola vertical installation, support on the floor, cabinet or shelf
Accessori da ordinare a parte Accessories not included	<p>- supporto da parete, rotazione fino a 160° e inclinazione fino a +/- 10°, QTowerSO</p> <p>Attenzione: di serie, il cabinet dei diffusori QTower, non ha i fori per il supporto.</p> <p>Pertanto indicare in fase d'ordine se si desidera installare la QTower a parete al fine di effettuare una corretta produzione.</p> <p>- base da pavimento (progetto, materiale e quotazione on demand)</p> <p>- wall mount, rotation up to 160° and inclination up to +/- 10°, QTowerSO</p> <p>Attention: as standard, the QTower speaker cabinet does not have holes for support.</p> <p>Therefore indicate when ordering if you want to install the QTower on the wall in order to carry out a correct production.</p> <p>- floor base (design, material and on-demand quotation)</p>		



QTOWER4

QTOWER4PRO

QTOWER4PROA



BASE DA PAVIMENTO PERSONALIZZABILE
(progetto e materiale) quotazione su richiesta

CUSTOMIZABLE FLOOR BASE
(project and material) quotation on demand

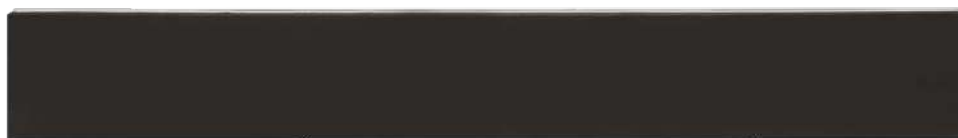

QTOWER4C





RECOMMENDED FOR	EAN13	CODE
	8051272186048	QTOWER6PRO
	8051272186055	QTOWER6PROA
	8051272186062	QTOWER8PRO
	8051272186079	QTOWER8PROA
	8051272186086	QTOWERMonitor

	QTOWER6PRO	QTOWER6PROA	QTOWER8PRO	QTOWER8PROA	QTOWERMonitor
Descrizione / Description	Diffusore di design, 100% Made In Italy dalle forme antirisonanti. Sistema a 2 vie per applicazioni professionali a lunga gittata (sale conferenze, auditorium, hotel, discolive...) Design speaker, 100% Made in Italy with anti-resonant shapes. 2 way system for long-range professional applications (conference rooms, auditoriums, hotels, discos...)				Diffusore di design, 100% Made In Italy dalle forme antirisonanti. Sistema a 2 vie Design speaker, 100% Made in Italy with anti-resonant shapes. 2 way system
Tweeter	al neodimio da 25 mm a compressione, alta efficienza, caricato su tromba esponenziale 80° di dispersione 25 mm compression neodymium, high efficiency, loaded on exponential horn 80° dispersion				a cupola di alta qualità da 25 mm in seta trattata antirisonante circuito magnetico di alta potenza al neodimio con dissipatore termico ad elevate prestazioni High Quality 25mm Dome In Anti-Sounding Treated Silk High Power Neodymium Magnetic Circuit with High Performance HeatSink
Mid-bass	6 XTDD da 13,5 cm 6 XTDD to 13,5 cm	6 XTDD da 13,5 cm 6 XTDD to 13,5 cm	8 XTDD da 13,5 cm 8 XTDD to 13,5 cm	8 XTDD da 13,5 cm 8 XTDD to 13,5 cm	4 XTDD da 15,1 cm 4 XTDD to 15,1 cm
Potenza RMS / musicale RMS / Music Power	350W/700W	---	500W/1000W	---	250W/500W
Impedenza / Impedance	5,5Ω	attiva biamplicato powersoft 380W+100W RMS active bi-amplified powersoft 380W+100W RMS	8Ω	attiva biamplicato powersoft 500W+100W RMS active bi-amplified powersoft 500W+100W RMS	4Ω
Risposta in frequenza / Sensibilità Frequency Response / Sensitivity	65-20000Hz/96dB	65-20000Hz	65-20000Hz/99dB	65-20000Hz	50-22000Hz/90dB
Max Output Level	---	123dB - peak 126dB	---	126dB - peak 129dB	---
Amplificazione consigliata Recommended amplification	da 80 a 350W RMS 80 to 350W RMS	---	da 80 a 500W RMS 80 to 500W RMS	---	da 80 a 250W RMS 80 to 250W RMS
Dimensioni (LxHxP) Size (WxHxD)	160x1420x145 mm	160x1420x145 mm	160x2020x145 mm	160x2020x145 mm	160x1220x145 mm
Peso / Weight	25 kg	26,5 kg	30 kg	31,5 kg	18 kg
Struttura / Structure	alluminio estruso da 4mm / 4mm extruded aluminium				
Finiture / Finishing	alluminio spazzolato brushed aluminium	alluminio spazzolato brushed aluminium	alluminio spazzolato brushed aluminium	alluminio spazzolato brushed aluminium	alluminio spazzolato brushed aluminium
Retina	rivestita in tela covered in canvas	rivestita in tela covered in canvas	rivestita in tela covered in canvas	rivestita in tela covered in canvas	rivestita in tela covered in canvas
Finiture personalizzabili Customizable finishing	colore e rivestimenti scocca, frontali e retina (quotazione a parte) color and coatings body, front and retina (quotation apart)				
Installazione / Installation	installazione verticale, appoggio su pavimento, mobile o mensola vertical installation, support on the floor, cabinet or shelf				
Accessori da ordinare a parte Accessories to be ordered separately	- supporto da parete, rotazione fino a 160° e inclinazione fino a +/- 10°, QTowerSO Attenzione: di serie, il cabinet dei diffusori QTower, non ha i fori per il supporto. Pertanto indicare in fase d'ordine se si desidera installare la QTower a parete al fine di effettuare una corretta produzione. - base da pavimento (progetto, materiale e quotazione on demand) - wall mount, rotation up to 160° and inclination up to +/- 10°, QTowerSO Attention: as standard, the QTower speaker cabinet does not have holes for support. Therefore indicate when ordering if you want to install the QTower on the wall in order to carry out a correct production. - floor base (design, material and on-demand quotation)				



diffusori HiFi in acciaio e legno
HiFi speakers in steel and wood

VIVALDI

QTOWER6PRO



QTOWER8PRO



Mid-woofer monitor

QTOWERMonitor



QTOWER8PROA

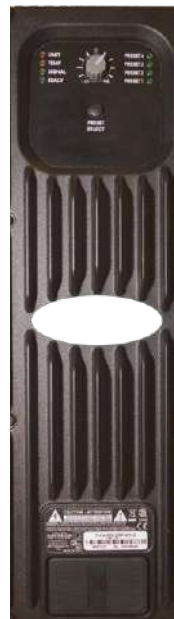



EAN13

CODE

8051272188745

QTOWERBP



IT - Base da pavimento, di design, per diffusori serie QTOWER. Materiale alluminio estruso. Colore silver. Finitura spazzolata. Personalizzazioni: colore e finitura (quotazione su richiesta).

EN - Floor base, design, for QTOWER series speakers. Extruded aluminum material. Silver color. Brushed finish. Customizations: color and finish (on-demand quotation).

8051272186093

QTOWERSO



IT - Supporto da parete orientabile per QTower
Rotazione fino a 160° e inclinazione fino a +/- 10°
Dimensioni (LxHxP): 104x80x68 mm
Peso 0,5 Kg
Carico massimo 40 Kg

EN - Adjustable wall mount for QTower
Rotation up to 160° and inclination up to +/- 10°
Size (WxHxD): 104x80x68 mm
Weight 0,5 Kg
Maximum load 40 Kg

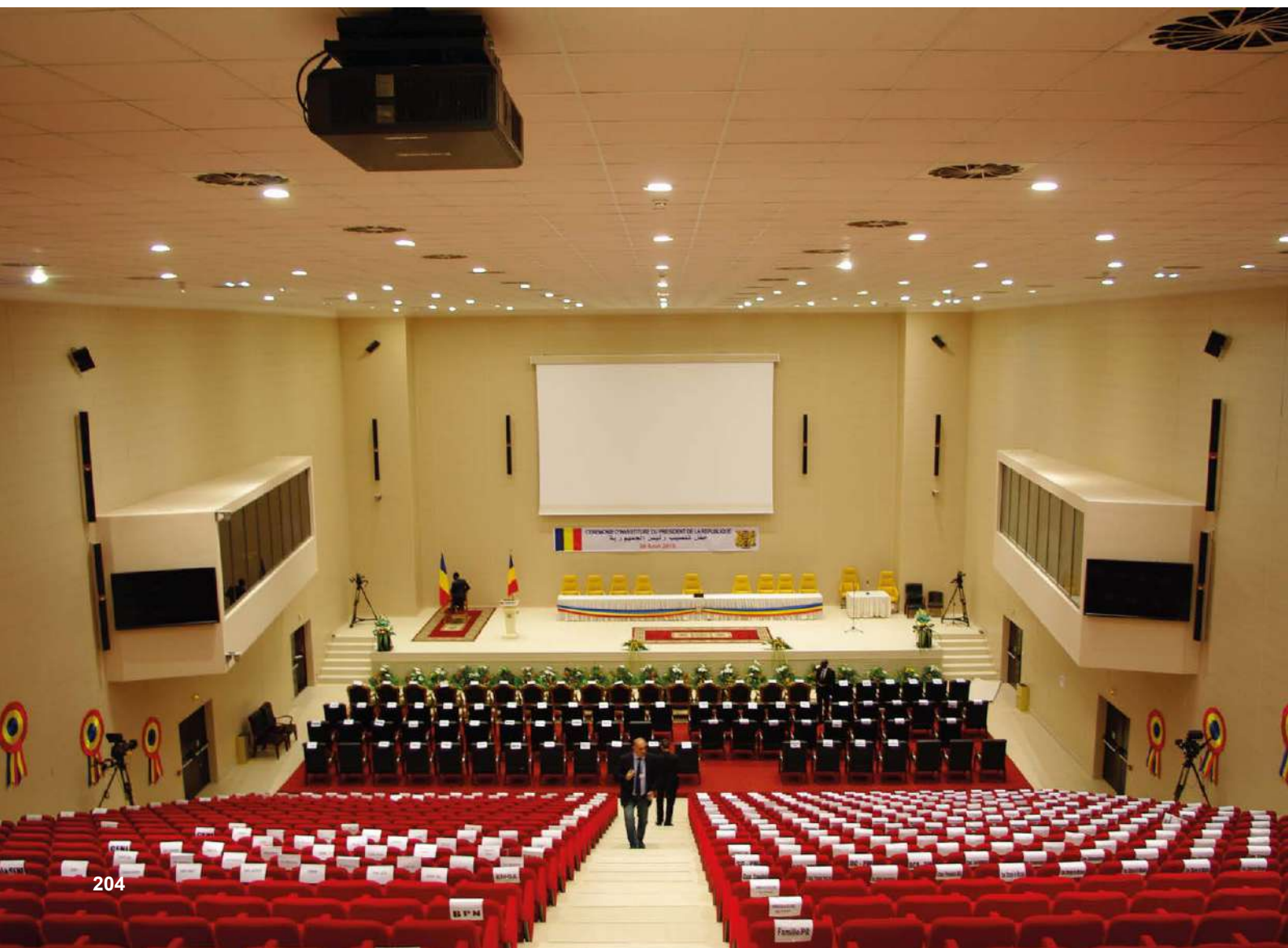





RECOMMENDED FOR

EAN13

CODE



8051272185324	MONOLITE1B nero / black
8051272185331	MONOLITE1W bianco / white
8051272185348	MONOLITE2B nero / black
8051272185355	MONOLITE2W bianco / white

126dB
full power



	MONOLITE1	MONOLITE2
Descrizione / Description	Diffusore 3 vie capace di riprodurre la purezza di un suono orchestrale con la completa gamma dinamica, dai pianissimo ai fortissimo, con subwoofer attivo, adatto per riproduzione audio stereo HiFi e Home Cinema. 3 way speaker capable of reproducing the purity of an orchestral sound with the complete dynamic range, from pianissimo to fortissimo, with active subwoofer, suitable for HiFi stereo audio reproduction and Home Cinema.	Diffusore 2 vie biampificato, adatto per riproduzione audio stereo HiFi e Home Cinema Bi-amplified 2 way speaker, suitable for HiFi stereo audio playback and Home Cinema
Woofers	2x32 cm	2x21 cm
Potenza RMS / musicale RMS / Music Power	1000W / 2000W	500W / 1000W
Midwoofer	16,5 cm in cassa accordata / 16.5 cm in tuned box	---
Tweeter	compressione al neodimio con membrana in titanio da 4,4 cm caricato a tromba a direttività controllata 90°x60° neodymium compression with 4,4 cm titanium diaphragm loaded with horn with controlled directivity 90°x60°	compressione ad alta efficienza con magnete ceramico e membrana in PEI da 3,8 cm caricato a tromba a direttività controllata (90°X60°) high efficiency compression with ceramic magnet and 3,8 cm PEI diaphragm loaded with controlled directivity horn (90°X60°)
Amplificatore per tweeter Tweeter amplifier	---	100W RMS
Impedenza / Impedance	4Ω	---
Risposta in frequenza / Sensibilità Frequency Response / Sensitivity	30-20000Hz / 96dB	45-20000Hz / 95dB
Max output level	125dB	122dB
Dimensioni (LxHxD) / Size (WxHxD)	440x1440x490 mm	300x1260x300 mm
Peso / Weight	52 kg	38 kg
Cabinet	legno multistrato di betulla / birch plywood	legno multistrato di betulla / birch plywood
Colori / Color	bianco / white nero / black	bianco / white nero / black
Finitura / Finishing	laccata o legno neutro / lacquered or neutral wood	laccata o legno neutro / lacquered or neutral wood
Finiture personalizzabili (quotazione a parte) Customizable finishing (quotation aside)	colore cabinet, colore retina, finitura (lucida, opaca, neutra...) cabinet color, retina color, finish (glossy, matte, neutral...).	



RECOMMENDED FOR

EAN13

CODE



8051272185362	MONOLITECENTERB nero / black
8051272185379	MONOLITECENTERW bianco / white
8051272185386	MONOLITESATB nero / black
8051272185393	MONOLITESATW bianco / white

125dB
full power



	MONOLITECENTER	MONOLITESAT
Descrizione / Description		
Midwoofer	16,5 cm in cassa accordata / 16.5 cm in tuned cabinet	16,5 cm in cassa accordata / 16.5 cm in tuned cabinet
Tweeter	a compressione al neodimio con membrana in titanio da 4,4 cm caricato a tromba a direttività controllata 90°x60° neodymium compression with 4,4 cm titanium diaphragm loaded with horn with controlled directivity 90°x60°	
Potenza RMS / musicale RMS / Music Power	500W / 1000W	500W / 1000W
Impedenza / Impedance	8Ω	4Ω
Risposta in frequenza / Sensibilità Frequency Response / Sensitivity	80-20000Hz/96dB	80-20000Hz/96dB
Max output level	123dB	123dB
Dimensioni (LxHxP) / Size (WxHxD)	220x620x220 mm	220x620x220 mm
Peso / Weight	10 kg	10 kg
Cabinet	legno multistrato di betulla / birch plywood	legno multistrato di betulla / birch plywood
Finitura / Finishing	laccata o legno neutro / lacquered or neutral wood	laccata o legno neutro / lacquered or neutral wood
Colore / Color	bianco / white nero / black	bianco / white nero / black
Finiture personalizzabili Customizable finishes	colore cabinet, colore retina, finitura (lucida, opaca, neutra...) cabinet color, retina color, finish (glossy, matte, neutral...)	colore cabinet, colore retina, finitura (lucida, opaca, neutra...) cabinet color, retina color, finish (glossy, matte, neutral...)



CI
NE
MA

Hi-Tech

&

Hand made

Benvenuti a casa o se preferite...a teatro!

Tutti abbiamo un nostro stile personale, gusti, sogni e aspirazioni. La nostra casa ci rappresenta, è un'espressione della nostra personalità unica. E ogni impianto Audio HiFi o Home Cinema dovrebbe essere unico, proprio come ogni personalità. Vivaldi progetta e costruisce mobili di design con l'audio integrato. Il vostro gusto sarà protagonista. La qualità audio ai massimi livelli.

Welcome home or if you prefer... at the theater!

We all have our own personal style, tastes, dreams and aspirations. Our home represents us, it is an expression of our unique personality. And every HiFi or Home Cinema audio system should be unique, just like every personality. Vivaldi designs and builds designer furniture with integrated audio. Your taste will be the protagonist. Audio quality at the highest level.

MADE IN ITALY,

nella mente nel cuore

La ricerca del suono migliore da ogni diffusore, dal più piccolo ed economico, ai mobili audio di arredamento realizzati artigianalmente, alle sale cinema certificabili THX, studiate progettate e prodotte da Vivaldi la rende uno dei pochi produttori Italiani con un simile livello qualitativo e di personalizzazione.

Per gli amanti dei pezzi unici, dei prodotti esclusivi, dell'alta moda, Vivaldi propone l'audio su misura, concetto che si contrappone ai prodotti "Prêt-à-porter" per citare un termine usato nella moda. Altro settore nel quale il Made in Italy è ai massimi livelli e ben apprezzato.

La passione e l'esperienza per il suono pulito capace di toccare le anime e creare emozioni uniche ha portato Vivaldi a sviluppare prodotti di arredamento acustico.

La customizzazione avviene a diversi livelli:

Rilevazioni acustiche ambientali con strumentazioni apposite i nostri tecnici effettueranno, in loco, le rilevazioni e gli studi ambientali per progettare poi un sistema di diffusori che vesta con un suono perfetto i vostri ambienti.

Design: la scelta delle forme e del design, dei colori e dei rivestimenti non è lasciata al caso, ogni particolare viene accuratamente scelto con la committenza o il progettista, per rispettare i gusti della stessa e per creare un prodotto che entri in perfetta armonia con l'ambiente dove andrà installato.

Progettazione: lo studio della fisica del suono, la scelta dei componenti, la progettazione degli spazi, la scelta della tipologia di legno... un lavoro instancabile su ogni prodotto.

Il fine creare un prodotto su misura, unico.

in the mind in the heart

The search for the best sound from every speaker, from the smallest and cheapest, to the handcrafted audio furniture, to the THX certifiable cinema rooms, designed and produced by Vivaldi makes it one of the few Italian manufacturers with a similar level of quality and customization.

For lovers of unique pieces, exclusive products, high fashion, Vivaldi offers tailor-made audio, a concept that contrasts with "Prêt-à-porter" products to quote a term used in fashion. Another sector in which Made in Italy is at the highest levels and well appreciated.

The passion and experience for clean sound capable of touching souls and creating unique emotions has led Vivaldi to develop acoustic furniture products.

Customization takes place at different levels:

Environmental acoustic surveys with special instruments, our technicians will carry out, on site, the surveys and environmental studies to then design a system of speakers that fits your environments with a perfect sound.

Design: the choice of shapes and design, colors and coatings is not left to chance, every detail is carefully chosen with the client or the designer, to respect the tastes of the same and to create a product that enters into perfect harmony with the environment where it will be installed.

Design: the study of the physics of sound, the choice of components, the design of spaces, the choice of the type of wood... tireless work on every product.

The aim is to create a tailor-made, unique product.



- **Controllo e misurazione intelligibilità ambiente.**
Ambient intelligibility control and measurement.
- **Verifica prestazioni audio secondo normativa THX.**
Verify audio performance according to THX regulations.

EAN13

CODE

8051272183764 **CMI1**

IT - INTELLIGIBILITA' AMBIENTALE
Controllo e misurazione intelligibilità ambiente, rilevazione di 16 punti con strumentazione certificata e rilascio delle misurazioni. Prezzo a forfait trasferta esclusa.

EN - INTELLIGIBILITY AMBIENTAL
Control and measurement of environmental intelligibility, detection of 16 points with certified instrumentation and release of measurements. Price per travel package excluded.



SOPRALLUOGO
INSPECTION



RILEVAZIONI ACUSTICHE
AMBIENTALI
(secondo normativa THX)
ACOUSTIC
ENVIRONMENTAL
(according to THX)
regulations)



PROGETTAZIONE
SURVEYS

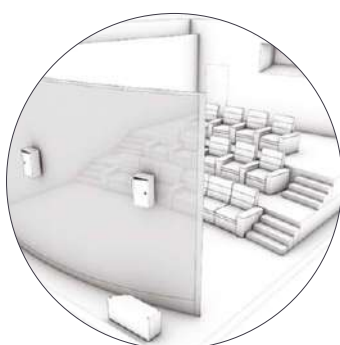

TRATTAMENTI ACUSTICI
AMBIENTALI
TREATMENTS
ACOUSTIC
ENVIRONMENTAL



REALIZZAZIONE
REALIZATION



TRASPORTO
INSTALLAZIONE
E MESSA IN FUNZIONE
TRANSPORT
INSTALLATION
AND COMMISSIONING

VIVALDI

CI NE MA

BENVENUTI A CASA

Benvenuti a casa o se lo preferite a teatro o in uno stadio. Tutti abbiamo un nostro stile personale, gusti, sogni e aspirazioni.

La nostra casa ci rappresenta, è un'espressione della nostra personalità.

E ogni impianto Audio HiFi o Home Cinema dovrebbe essere unico, proprio come la propria personalità.

Vivaldi progetta e realizza sale cinema private e mobili di design con l'audio integrato.

Il vostro gusto sarà protagonista.

La qualità audio ai massimi livelli.



WELCOME AT HOME

Welcome home or if you prefer it at the theater or in a stadium.

We all have our own personal style, tastes, dreams and aspirations.

Our house represents us, it is an expression of our personality.

And every HiFi or Home Cinema Audio system should be unique, just like your personality.

Vivaldi designs and manufactures private cinemas and design furniture with integrated audio.

Your taste will be the protagonist.

Audio quality at the highest level.



La passione per il suono pulito capace di toccare l'anima e l'esperienza di oltre 50' anni, l'innovazione e la tecnologia portano Vivaldi a sviluppare arredamento acustico personalizzato.

Ogni particolare viene accuratamente scelto con la committenza o il progettista.

Lo studio della fisica del suono, la progettazione degli spazi, la scelta delle tipologie di materiale... un lavoro instancabile su ogni soluzione proposta.

The passion for clean sound capable of touching the soul and the experience of over 50 years, innovation and technology lead Vivaldi to develop personalized acoustic furniture.

Every detail is carefully chosen with the client or the designer.

The study of the physics of sound, the design of spaces, the choice of types of material... tireless work on every solution proposed.



LAVORAZIONI ARTIGIANALI CRAFTSMANSHIP



CINEMA

VIVALDI



VIVALDI

CINEMA



CINEMA

VIVALDI

STUDIO ACUSTICA AMBIENTALE

Con strumentazioni apposite i nostri tecnici effettueranno, in loco, le rilevazioni acustiche e gli studi ambientali per progettare un sistema che vesta con un suono perfetto la vostra sala.



ACOUSTICS ENVIRONMENTAL

With special instruments, our technicians will carry out, on site, acoustic surveys and environmental studies to design a system that fits your room with a perfect sound.



VIVALDI

CINEMA

HI-TECH MULTIMEDIALE

Vivaldi propone soluzioni per lo smart cinema ed il controllo domotico degli impianti audio, video, luci, multimediali.

Il controllo avviene tramite app gratuita. L'interfaccia utente può essere a lista o grafica e personalizzabile.

I controlli possono essere effettuati tramite la rete locale o da remoto.

HI-TECH MULTIMEDIALE

Vivaldi offers solutions for smart cinema and home automation for audio, video, lighting and multimedia systems.

The control is managed via free app. The user interface can be used via list or graphic design and customizable.

Controls can be managed via local network or remotely.



BENVENUTI A CASA

Con strumentazioni apposite i nostri tecnici effettueranno, in loco, le rilevazioni acustiche e gli studi ambientali per progettare un sistema che vesta con un suono perfetto la vostra sala.



WELCOME AT HOME

With special instruments, our technicians will carry out, on site, acoustic surveys and environmental studies to design a system that fits your room with a perfect sound.



CONDIZIONI GENERALI DI VENDITA IN VIGORE DAL 01.11.2019

PREMESSA

Le seguenti Condizioni Generali di Vendita regolano i rapporti commerciali fra Vivaldi SRL ed i suoi Acquirenti, di seguito nominati Clienti. Il conferimento di un ordine a Vivaldi SRL implica l'accettazione integrale delle seguenti condizioni.

1 - RESPONSABILITA'

Vivaldi SRL non potrà essere ritenuta responsabile per:

- danni da perdite di merci avvenute durante il trasporto, anche se effettuato dai vettori convenzionati con Vivaldi SRL;
- danni o difetti delle merci causati da qualsiasi azione, negligenza o mancanza da parte del Cliente o di terzi;
- danni conseguenti a difetti delle merci dovuti a vizi di materiali o di lavorazione, se non contestati per iscritto entro otto giorni dal ricevimento delle merci;
- danni di qualsiasi natura derivanti dal mancato assolvimento dei propri impegni per cause di forza maggiore (a titolo esemplificativo ma non limitato: scioperi, incidenti, calamità....);
- eventuali ritardi nella spedizione della merce, dovuti a cause di forza maggiore, che non potranno dar luogo a richiesta di risarcimento da parte del Cliente;
- piccole varianti nelle caratteristiche tecniche dei prodotti, quali dimensioni o colore dei prodotti, che sono rilevati al momento della preparazione del listino o del catalogo;
- eliminazione di articoli o modifiche dei vari prodotti, indicati nel listino in vigore, motivate dalle mutate condizioni di mercato.

La responsabilità totale di Vivaldi SRL non potrà, in alcun caso, essere superiore al valore della merce difettosa o danneggiata, calcolato in base ai prezzi praticati sulla fattura corrispondente.

2 - ORDINI

Gli ordini saranno accettati solo ed esclusivamente in forma scritta, a mezzo fax o e-mail, su carta intestata del Cliente. Sull'ordine dovranno sempre essere presenti l'esatta ragione sociale comprensiva di indirizzo, la partita Iva, il codice fiscale, il riferimento della persona incaricata a seguire l'ordine, la quantità della merce, il nostro codice prodotto come riportato sul listino di vendita, la destinazione della spedizione se diversa dalla sede del Cliente, e l'eventuale indicazione del vettore convenzionato col Cliente per l'inoltro delle merci o i nostri abituali vettori. Per gli ordini con pagamento bonifico bancario anticipato la spedizione della merce avverrà solo dopo che Vivaldi SRL avrà ricevuto l'accredito del bonifico in c/c.

Il trasporto è effettuato con addebito in fattura:

- Materiale a catalogo Vivaldi: per ordini inferiori a 300,00€ il trasporto verrà effettuato in porto franco con addebito del costo in fattura. Per ordini superiori ai 300,00€ in porto franco addebito 2% in fattura. In alternativa il cliente potrà scegliere di far viaggiare la merce in p.to assegnato.
- Materiale Trade (fuori catalogo): verrà sempre addebitato in fattura un costo fisso come 'rimborso contributo movimentazione di magazzino' pari al 2% dell'imponibile, questo costo non è comprensivo o sostitutivo del trasporto. Il trasporto verrà quantificato a parte come segue: per ordini inferiori a 300,00€ verrà effettuato in porto franco con addebito del costo in fattura. Per ordini superiori ai 300,00€ in porto franco addebito 2% in fattura. Il cliente potrà scegliere di far viaggiare la merce in p.to assegnato con il corriere che vorrà indicare.

La richiesta di evasione anticipata di ordini i cui prodotti non sono tutti disponibili, determina un ulteriore addebito di trasporto per la spedizione del saldo ordine. I termini di spedizione eventualmente indicati nell'ordine sono sempre indicativi eventuali ritardi non comporteranno alcun onere aggiuntivo alla Vivaldi srl.

- Triangolazione: per il materiale spedito in filiale, al cliente, in cantiere verrà sempre addebitato in fattura un costo fisso di euro 10,00 in aggiunta alle spese di trasporto.
- Contrassegno: per le spedizioni con contrassegno verrà sempre addebitato in fattura un costo fisso di euro 10,00 in aggiunta alle spese di trasporto.
- Fermo deposito: il servizio di fermo deposito è gratuito per il primo giorno, per ogni giorno il ritardo nel ritiro verrà addebitato in fattura un costo fisso di euro 20,00.

3 - PREZZI

I prezzi di vendita sono quelli presenti sul Listino Prezzi Generale al pubblico Vivaldi – Iva esclusa – sempre consultabili sul sito www.Vivaldigroup.it, area riservata. Le promozioni si intendono per quantità ed il prezzo è indicato netto o con scontistica particolare. I prezzi si intendono franco il magazzino Vivaldi SRL. L'imponibile netto minimo di fatturazione è fissato in Euro 300,00, spese accessorie escluse.

4 - IMBALLAGGIO MERCI

Si intende incluso nei prezzi di vendita, salvo i casi in cui venga espressamente preventivato.

Le spedizioni su pallet si intendono incluse nei prezzi di vendita, salvo i casi in cui venga espressamente preventivato.

5 - MERCE IN PRESTITO D'USO E CAMPIONATURE DI MERCE

Non sarà dato corso a richieste di merce in visione. Le campionature di merce potranno essere fornite esclusivamente in prestito d'uso. Oltrepassato il termine di prestito d'uso indicato in bolla, senza che la merce sia stata restituita a Vivaldi srl, tali campionature saranno fatturate al Cliente ed in nessun caso potranno essere restituite a Vivaldi SRL e/o dar luogo a rimborsi.

6 - SPEDIZIONI

Le nostre spedizioni sono tutte effettuate, in Porto Franco con addebito in fattura, tramite nostri vettori convenzionati ed assicurate, salvo diversa indicazione del Cliente di Porto Assegnato. Il costo del trasporto, addebitato in fattura, varia a seconda del vettore scelto (messaggeria o vettore espresso), del servizio, del peso e del volume della merce. I servizi accessori al trasporto, quali ad esempio la richiesta di preavvisi telefonici, il contrassegno, le consegne a terzi, le consegne in località disagiate o in centri storici e le consegne particolari (ai piani, utilizzo di gru, utilizzo di sponda idraulica ecc...), saranno addebitati in fattura: la richiesta di tali servizi accessori va fatta in fase d'ordine e non successivamente. Il trasporto è effettuato con le modalità ritenute opportune da Vivaldi SRL. La merce viaggia a rischio e pericolo del Cliente in conformità all'art.1693 C.C. (responsabilità del vettore per perdita ed avaria). Se il Cliente richiede un proprio trasportatore, Vivaldi SRL non sarà responsabile della perdita e/o avaria del prodotto fin dal momento della consegna della merce presso i propri magazzini.

Il Cliente ha sempre l'obbligo, qualora al ricevimento della merce l'imballo risultasse danneggiato o manomesso, di accettare con riserva, indicando la seguente dicitura:

"collo schiacciato accettato con riserva di verifica integrità merce" oppure

"collo scondizionato verifica di integrità merce"

Il Cliente dovrà darci immediata comunicazione entro le 24 ore successive al ricevimento della merce specificando il danno subito, ed allegando copia del DDT ed eventuali foto giustificative. Al ricevimento della merce il Cliente è tenuto ad esaminare attentamente la stessa: la verifica riguarda lo stato, il peso, la quantità e il tipo degli articoli. Nessun reclamo potrà essere preso in considerazione trascorso il termine di otto giorni dal ricevimento. Qualora non venisse rispettata la suddetta procedura, Vivaldi SRL si riterrà sollevata da ogni responsabilità.

Pur in presenza di imballo integro, la merce dovrà essere verificata entro otto giorni dal ricevimento, pena la decadenza di responsabilità del vettore (Art.1698 C.C.). Pertanto, eventuali anomalie occulte, dovranno essere segnalate per iscritto a mezzo fax o email: ogni segnalazione oltre i suddetti termini non potrà essere presa in considerazione. Per ogni dichiarazione, il Cliente, si assume la piena responsabilità di quanto dichiarato.

7 - RESTITUZIONE MERCI DANNEGGIATE DURANTE IL TRASPORTO

Danni o manomissioni verificatisi durante al trasporto dovranno essere segnalati al vettore contestualmente all'accettazione spedizione che deve essere firmata con la dicitura "si accetta con riserva di controllo". Il Cliente dovrà provvedere a rendere la merce risultante danneggiata in p.to franco. Sulla bolla di reso, oltre a citare gli estremi della nostra bolla di consegna, il Cliente deve indicare nella casella predisposta per la causale del trasporto la dicitura "Reso per danno da trasporto".

8 - RESTITUZIONE MERCI NON CONFORMI

Non si accettano resi se non specificamente autorizzati dalla Vivaldi SRL.

Ogni reso deve essere gestito tramite RMA, un numero identificativo di pratica che viene rilasciato da Vivaldi SRL al Cliente. Per ricevere il nr di RMA il cliente dovrà compilare il seguente form <http://Vivaldigroup.it/it/rma>. Il numero di RMA dovrà essere riportato all'esterno del collo e in bolla. Il trasporto dovrà essere esclusivamente in porto franco con allegato il documento di trasporto e la fattura di vendita (se il prodotto è in garanzia). La merce resa senza autorizzazione verrà respinta al mittente. I prodotti riconosciuti difettosi da Vivaldi SRL per cause dipendenti dal materiale o dalla sua lavorazione, purché impiegati correttamente, verranno da Vivaldi SRL rimessi a nuovo o sostituiti con altri privi di difetti ed aventi le medesime caratteristiche. La garanzia non copre i prodotti oggetto di modifiche e manomissioni da parte del Cliente. La responsabilità di Vivaldi SRL resta in ogni caso strettamente limitata alla riparazione/sostituzione escludendo la manodopera impiegata dal Cliente per lo smontaggio ed il rimontaggio del prodotto reso. Non sono pertanto accettate richieste di danni, penali o altro, in relazione a quanto risultato difettoso, a seguito verifica, da Vivaldi SRL.

9 - GARANZIA

Il documento che certifica la garanzia è la fattura di vendita. La validità della garanzia di un prodotto sarà certificata esclusivamente dal laboratorio tecnico della Vivaldi SRL. Il periodo di garanzia avrà la durata di 12 mesi, dalla data di consegna merce. I prodotti al momento della riconsegna non devono risultare manomessi. La Vivaldi SRL si impegnerà alla sostituzione o riparazione delle parti componenti la fornitura, che risultassero difettose per cattiva qualità di materiale o per difetto di lavorazione, sempre che ciò non dipenda da imperizia o negligenza, manomissioni, da casi fortuiti o di forza maggiore. I lavori inerenti alle riparazioni o sostituzioni in garanzia saranno eseguiti dai laboratori della Vivaldi SRL oppure sul posto, senza che ciò comporti nessuna responsabilità a carico della Vivaldi srl per danni diretti o indiretti subiti dal cliente a causa di ciò. Laddove ragioni di esercizio imponessero di riparare le apparecchiature sul posto, restano a carico del cliente le spese di trasferimento e di permanenza fuori sede del personale tecnico, che verranno addebitate con regolare fattura. In caso di inosservanza di una o più norme sopra elencate la garanzia decade.

10 - RESTITUZIONE MERCI

Qualsiasi restituzione dovrà essere preventivamente autorizzata con assegnazione di RMA, dalla Vivaldi SRL. La merce non potrà essere restituita a causa di errato ordine, trascorsi 8gg dal ricevimento della stessa (fa fede la data del bollettino di consegna del vettore).

11 - RECLAMI

Eventuali errori di spedizione merci imputabili a Vivaldi SRL o mancanze di materiale indicato sul DDT, dovranno essere segnalate in forma scritta entro otto giorni dal ricevimento dell'invio (fa fede la data del bollettino di consegna del vettore incaricato).

12 - TERMINI DI CONSEGNA - URGENZE

La maggior parte dei prodotti presenti nel listino è pronta a magazzino, salvo il venduto: in tal caso ordini trasmessi entro le ore 18:00 verranno evasi entro il giorno seguente. Gli ordini aventi carattere di urgenza, con spedizione prevista per il giorno stesso a mezzo corriere espresso, devono pervenire entro le ore 12:00 del giorno in cui si richiede la spedizione. Nell'ordine deve essere indicato il modo chiaro e ben visibile il carattere di urgenza.

13 - RISERVA DI DOMINIO

Le merci consegnate restano di proprietà di Vivaldi SRL fino al momento del pagamento integrale della merce ai sensi degli art. 1523-1526 del C.C.: fino ad allora il Cliente non è autorizzato a cedere la merce in pegno o a garanzia di un credito. Nel caso di rivendita regolare della merce, il credito derivante è considerato come ceduto a Vivaldi SRL.

14 - PAGAMENTI

Il pagamento verrà concordato con l'ufficio commerciale della Vivaldi SRL, eventuali pagamenti dilazionati richiederanno sempre e comunque l'esito positivo dell'affidamento credito. L'affidamento credito non comporta oneri finanziari a carico del Cliente. Qualsiasi altra condizione di pagamento riportata sugli ordini del Cliente non sarà presa in considerazione se non espressamente concordata. Vivaldi SRL si riserva, a suo insindacabile giudizio, il diritto di modificare le condizioni di pagamento a quei Clienti che risultassero "fuori fido", con "credito insoluto" o in "contenzioso". Vivaldi SRL si riserva il diritto di non evadere ordini a Clienti insolventi. In caso di ritardato pagamento, Vivaldi SRL si riserva il diritto di richiedere al Cliente insolvente il risarcimento dei costi per il recupero del credito nonché ad applicare gli interessi moratori, come previsto dal D.Lgs. 231/2002. Sui ritardati pagamenti sarà inoltre addebitato l'eventuale sconto cassa detratto in fattura. Si ribadisce che il ritardo nei pagamenti o qualsiasi inadempienza da parte di clienti daranno alla Vivaldi SRL la facoltà di sospendere l'evasione degli ordini e delle prenotazioni, nonché di annullare qualsiasi altra condizione commerciale in corso.

15 - DIRITTO DI ANNULLAMENTO DEGLI ORDINI

Il Cliente potrà chiedere, esclusivamente in forma scritta, l'annullamento dell'intero ordine o di parte di esso entro 24 ore dall'inoltro.

16 - TRATTAMENTO DEI DATI PERSONALI

Ai sensi del D.Lgs. 30/06/2003 n.196, il Cliente dà atto che i dati personali comunicati e/o scambiati, anche in fase di informative precontrattuali, formeranno oggetto di trattamento per gli effetti e con le finalità di cui all'Art.24, comma 1, lett. b) e successive modificazioni ed integrazioni dello stesso D.Lgs. 196/2003. Resta inoltre inteso che il Cliente espressamente acconsente al trasferimento dei dati personali ai sensi e per gli effetti dell'Art.43, comma 1, lett. b) del D.Lgs 196/2003 e, comunque, alla loro comunicazione e diffusione.

17 - CONTROVERSIE

Per ogni controversia che dovesse insorgere sarà competente il Foro di San Dona' di Piave (VE).

GENERAL CONDITIONS OF SALE EFFECTIVE FROM 01.11.2019

PREMISE

The following General Conditions of Sale govern the commercial relations between Vivaldi SRL and its Buyers, hereinafter referred to as Customers. The conferment of an order to Vivaldi SRL implies full acceptance of the following conditions.

1 - LIABILITY

Vivaldi SRL cannot be held responsible for:

- damage from loss of goods occurred during transport, even if carried out by carriers affiliated with Vivaldi SRL;
 - damage or defects of the goods caused by any action, negligence or lack on the part of the Customer or third parties;
 - damage resulting from defects in the goods due to defects in materials or workmanship, if not contested in writing within eight days of receipt of the goods;
 - damages of any kind deriving from the failure to fulfill its commitments due to force majeure (by way of example but not limited: strikes, accidents, disasters ...);
 - any delays in the shipment of the goods, due to force majeure, which cannot give rise to a request for compensation by the Customer;
 - small variations in the technical characteristics of the products, such as size or color of the products, which are detected at the time of preparation of the price list or catalog;
 - elimination of articles or modifications of the various products, indicated in the price list in force, motivated by changed market conditions.
- The total liability of Vivaldi SRL cannot, in any case, be higher than the value of the defective or damaged goods, calculated on the basis of the prices charged on the corresponding invoice.

2 - ORDERS

Orders will be accepted only and exclusively in writing, by fax or e-mail, on the Customer's letterhead. On the order must always be present the exact company name including address, VAT number, tax code, the reference of the person in charge of following the order, the quantity of the goods, our product code as shown on the sales list, the destination of the shipment if different from the customer's location, and any indication of the carrier affiliated with the customer for the forwarding of goods or our usual carriers. For orders with advance bank transfer payment, the shipment of the goods will take place only after Vivaldi SRL has received the credit of the transfer in c / c.

The transport is carried out with charge on the invoice:

- Material in the Vivaldi catalogue: for orders of less than € 300.00, transport will be carried out carriage paid with the cost charged on the invoice. For orders over € 300.00 in port free of charge 2% on the invoice. Alternatively, the customer can choose to have the goods traveled in port assigned.
 - Material Trade (out of catalog): a fixed cost will always be charged on the invoice as a 'warehouse handling contribution refund' equal to 2% of the taxable amount, this cost is not inclusive or substitute for transport. The transport will be quantified separately as follows: for orders less than € 300.00 will be carried out carriage paid with the cost charged on the invoice. For orders over € 300.00 in port free of charge 2% on the invoice. The customer can choose to travel the goods in port assigned with the courier he wants to indicate.
- The request for early fulfillment of orders whose products are not all available, determines an additional transport charge for the shipment of the order balance. Any shipping terms indicated in the order are always indicative of any delays that will not entail any additional charge to Vivaldi srl.
- Triangulation: for the material shipped to the branch, the customer, on site will always be charged on the invoice a fixed cost of € 10.00 in addition to the transport costs.
 - Cash on delivery: for shipments with cash on delivery will always be charged on the invoice a fixed cost of € 10.00 in addition to transport costs.
 - Deposit stop: the deposit stop service is free for the first day, for each day the delay in the withdrawal will be charged on the invoice a fixed cost of € 20.00.

3 - PRICES

The sales prices are those on the Vivaldi General Price List – excluding VAT – always available on the website www.Vivaldigroup.it, reserved area. The promotions are intended by quantity and the price is indicated net or with special discounts. Prices are excl. the WAREHOUSE Vivaldi SRL. The minimum net invoicing taxable amount is set at Euro 300.00, excluding ancillary costs.

4 - GOODS PACKAGING

It is considered included in the sale prices, except in cases where it is expressly quoted.

Shipments on pallets are considered included in the sales prices, except in cases where it is expressly budgeted.

5 - GOODS ON LOAN FOR USE AND SAMPLES OF GOODS

Requests for goods in vision will not be processed. The samples of goods can only be included on loan for use. After the term of loan of use indicated in the bill, without the goods having been returned to Vivaldi srl, these samples will be invoiced to the Customer and in no case can be returned to Vivaldi SRL and / or give rise to refunds.

6 - SHIPPING

Our shipments are all made, in Free Port with charge on the invoice, through our affiliated and insured carriers, unless otherwise indicated by the Assigned Port Customer. The cost of transport, charged on the invoice, varies depending on the carrier chosen (messenger or express carrier), the service, the weight and volume of the goods. Ancillary services to transport, such as the request for telephone advances, cash on delivery, deliveries to third parties, deliveries to disadvantaged locations or in historic centers and special deliveries (on the floors, use of freight elevator, use of hydraulic tailgate etc ...), will be charged on the invoice: the request for these ancillary services must be made during the order phase and not subsequently. The transport is carried out in the manner deemed appropriate by Vivaldi SRL. The goods travel at the risk and peril of the Customer in accordance with Article 1693 of .C. (liability of the carrier for loss and damage). If the Customer requests his own carrier, Vivaldi SRL will not be responsible for the loss and / or damage of the product from the moment of delivery of the goods to its warehouses.

The Customer is always obliged, if upon receipt of the goods the packaging is damaged or tampered with, to accept with reserve, indicating the following wording:

"crushed package accepted subject to verification of the integrity of the goods" or

"unconditioned package verification of integrity of goods"

The Customer must immediately notify us within 24 hours of receipt of the goods specifying the damage suffered, and attaching a copy of the Transport document and any supporting photos. Upon receipt of the goods, the Customer is required to carefully examine the same: the verification concerns the condition, weight, quantity and type of items. No complaint can be taken into account after the term of eight days from receipt. If the aforementioned procedure is not respected, Vivaldi SRL will be considered relieved of all responsibility.

Even in the presence of intact packaging, the goods must be verified within eight days of receipt, under penalty of forfeiture of responsibility of the carrier (Art.1698 C.C.). Therefore, any hidden anomalies must be reported in writing by fax or email: any report beyond the aforementioned terms cannot be taken into consideration. For each declaration, the Customer assumes full responsibility for what is declared.

7 - RETURN OF GOODS DAMAGED DURING TRANSPORT

Damage or tampering occurred during transport must be reported to the carrier at the same time as acceptance of the shipment which must be signed with the words "accepted subject to control". The Customer must return the resulting damaged goods in free port. On the return note, in addition to mentioning the details of our delivery note, the Customer must indicate in the box prepared for the reason for transport the words "Return for transport damage".

8 - RETURN OF NON-COMPLIANT GOODS

We do not accept returns unless specifically authorized by Vivaldi SRL.

Each return must be managed through RMA, a file identification number that is issued by Vivaldi SRL to the Customer. To receive the RMA number, the customer must fill out the following form <http://Vivaldigroup.it/it/rma>. The RMA number must be shown on the outside of the package and in a bubble. The transport must be exclusively in carriage paid with the transport document and the sales invoice attached (if the product is under warranty). Goods returned without authorization will be rejected to the sender. The products recognized as defective by Vivaldi SRL for reasons dependent on the material or its processing, provided they are used correctly, will be refurbished or replaced by Vivaldi SRL with others free of defects and having the same features. The warranty does not cover products subject to modification and tampering by the Customer. The responsibility of Vivaldi SRL remains in any case strictly limited to the repair / replacement excluding the labor used by the Customer for the disassembly and reassembly of the returned product. Therefore, claims for damages, penalties or other, are not accepted in relation to what is defective, following verification, by Vivaldi SRL.

9 - WARRANTY

The document certifying the warranty is the sales invoice. The validity of the warranty of a product will be certified exclusively by the technical laboratory of Vivaldi SRL. The warranty period will last 12 months, from the date of delivery of goods. The products at the time of return must not be tampered with. Vivaldi SRL will undertake to replace or repair the parts of the supply, which are defective due to poor quality of material or lack of workmanship, provided that this does not depend on incompetence or negligence, tampering, fortuitous events or force majeure. The works related to repairs or replacements under warranty will be carried out by the laboratories of Vivaldi SRL or on site, without this entailing any liability on the part of Vivaldi srl for direct or indirect damages suffered by the customer due to this. Where operating reasons require the equipment to be repaired on site, the customer is responsible for the costs of transfer and stay off-site of the technical staff, which will be charged with a regular invoice. In case of non-compliance with one or more of the rules listed above, the warranty is void.

10 - RETURN OF GOODS

Any return must be previously authorized with the assignment of RMA, by Vivaldi SRL. The goods cannot be returned due to incorrect order, after 8 days from receipt of the same (the date of the carrier's delivery note is authentic).

11 - COMPLAINTS

Any errors in the shipment of goods attributable to Vivaldi SRL or lack of material indicated on the Transport document, must be reported in writing within eight days of receipt of the shipment (the date of the delivery note of the carrier in charge is authentic).

12 - DELIVERY TERMS - URGENCIES

Most of the products in the price list are ready in stock, except for the sold: in this case orders sent by 18:00 will be processed within the following day. Orders of an urgent nature, with shipment scheduled for the same day by express courier, must be received by 12:00 on the day on which the shipment is requested. In the order must be indicated the clear ways and clearly visible the character of urgency.

13 - RESERVATION OF TITLE

The delivered goods remain the property of Vivaldi SRL until the time of full payment of the goods pursuant to art. 1523-1526 of the C.C.: until then the Customer is not authorized to transfer the goods as a pledge or to guarantee a credit. In the case of regular resale of the goods, the resulting credit is considered as transferred to Vivaldi SRL.

14 - PAYMENTS

The payment will be agreed with the sales office of Vivaldi SRL, any deferred payments will always require the positive outcome of the credit assignment. The assignment of credit does not entail financial charges borne by the Customer. Any other payment conditions shown on the Customer's orders will not be taken into account unless expressly agreed. Vivaldi SRL reserves, at its sole discretion, the right to modify the payment conditions to those Customers who are "out of credit", with "unpaid credit" or in "litigation". Vivaldi SRL reserves the right not to process orders to insolvent customers. In case of late payment, Vivaldi SRL reserves the right to request the insolvent Customer to compensate the costs for the recovery of the credit as well as to apply default interest, as provided for from Legislative Decree 231/2002. Late payments will also be charged any cash discount deducted on the invoice. It is reiterated that late payments or any non-compliance by customers will give Vivaldi SRL the right to suspend the processing of orders and reservations, as well as to cancel any other commercial condition in progress.

15 - RIGHT TO CANCEL ORDERS

The Customer may request, exclusively in writing, the cancellation of the entire order or part of it within 24 hours of submission.

16 - PROCESSING OF PERSONAL DATA

Pursuant to Legislative Decree 30/06/2003 n.196, the Customer acknowledges that the personal data communicated and / or exchanged, even during the pre-contractual information phase, will be processed for the purposes and for the purposes referred to in Article 24, paragraph 1, letter .b) and subsequent amendments and additions to Legislative Decree 196/2003. It is also understood that the Customer expressly consents to the transfer of personal data pursuant to and for the purposes of Article 43, paragraph 1, letter .b) of Legislative Decree 196/2003 and, in any case, to their communication and dissemination.

17 - DISPUTES

For any dispute that may arise, the Court of San Dona' di Piave (VE) will be competent.

A25SBTC	8051272189773	pag. 36	AD7S	8051272181937	pag. 54
AC5	8051272181401	pag. 43	AD7W	8051272181944	pag. 54
AD10B	8051272181593	pag. 54	AD8B	8051272181951	pag. 54
AD10S	8051272181609	pag. 54	AD8S	8051272181968	pag. 54
AD10W	8051272181616	pag. 54	AD8W	8051272181975	pag. 54
AD11B	8051272181623	pag. 54	AD9B	8051272181982	pag. 54
AD11S	8051272181630	pag. 54	AD9S	8051272181999	pag. 54
AD11W	8051272181647	pag. 54	AD9W	8051272182002	pag. 54
AD12B	8051272181654	pag. 54	AF2	8051272189674	pag. 90
AD12S	8051272181661	pag. 54	AF3	8051272186956	pag. 90
AD12W	8051272181678	pag. 54	AIR20T	8051272181425	pag. 166
AD13B	8051272181685	pag. 54	AIR30TB	8052015551130	pag. 167
AD13S	8051272181692	pag. 54	AIR30TW	8052015551147	pag. 167
AD13W	8051272181708	pag. 54	AIR40TB	8052015551154	pag. 167
AD14B	8051272181715	pag. 55	AIR40TW	8052015551161	pag. 167
AD14S	8051272181722	pag. 55	AIR50TB	8051272189728	pag. 167
AD14W	8051272181739	pag. 55	AIR50TW	8052015550072	pag. 167
AD15B	8051272187960	pag. 55	AIRPOWER16TB	8051272181432	pag. 166
AD15SABBIA	8051272188394	pag. 55	AIRPOWER16TW	8051272183504	pag. 166
AD15W	8051272187984	pag. 55	AL10B	8051272189834	pag. 32
AD16B	8052015550737	pag. 55	AL201D	8051272183511	pag. 56
AD16C	8052015550744	pag. 55	AL203	8051272180312	pag. 32
AD16W	8052015550720	pag. 55	AL2B	8051272189353	pag. 32
AD1B	8051272181746	pag. 54	AL3B	8051272189360	pag. 32
AD1S	8051272181753	pag. 54	AL5B	8051272189377	pag. 32
AD1W	8051272181760	pag. 54	AL6B	8051272189803	pag. 13
AD2B	8051272181777	pag. 54	AL7B	8051272189810	pag. 32
AD2S	8051272181784	pag. 54	AL8	8051272183535	pag. 37
AD2W	8051272181791	pag. 54	AL9B	8051272189827	pag. 32
AD3B	8051272181807	pag. 54	AMBRA10TB	8051272182637	pag. 159
AD3S	8051272181814	pag. 54	AMBRA10TW	8051272182651	pag. 159
AD3W	8051272181821	pag. 54	AMBRA16TB	8051272182675	pag. 159
AD4B	8051272181838	pag. 54	AMBRA16TW	8051272182699	pag. 159
AD4S	8051272181845	pag. 54	AMBRA21TB	8051272182750	pag. 159
AD4W	8051272181852	pag. 54	AMBRA21TW	8051272182767	pag. 159
AD5B	8051272181869	pag. 54	AMBRA9TB	8051272180176	pag. 159
AD5S	8051272181876	pag. 54	AMBRA9TW	8051272180183	pag. 159
AD5W	8051272181883	pag. 54	ANNA13TB	8052015550027	pag. 161
AD6B	8051272181890	pag. 54	ANNA13TW	8052015550010	pag. 161
AD6S	8051272181906	pag. 54	ANNA16TB	8052015550041	pag. 161
AD6W	8051272181913	pag. 54	ANNA16TW	8052015550034	pag. 161
AD7B	8051272181920	pag. 54	ANNA20TB	8052015550065	pag. 161



ANNA20TW	8052015550058	pag. 161	E80S	8051272188066	pag. 31
AUXIN	8051272183542	pag. 56	EVO.BRIDGE	8051272187335	pag. 104
BATTERIA125AH	8051272183566	pag. 128	EVO.CVF	8051272188011	pag. 123
BATTERIA12AH	8052015550690	pag. 128	EVO.EXPIBOARD	8052015550942	pag. 108
BATTERIA26AH	8051272183573	pag. 128	EVO.PAT	8051272188363	pag. 123
BATTERIA40AH	8051272183580	pag. 128	EVO.RACKADP	8051272189216	pag. 110
BATTERIA69AH	8051272183597	pag. 128	EVO.SE	8051272183887	pag. 126
BATTERIA93AH	8051272183603	pag. 128	EVO.VISION	8051272187342	pag. 103
BM1000D	8051272188325	pag. 86	EVO+12X9	8051272180800	pag. 129
BM5000	8051272183627	pag. 87	EVO+3X100	8051272180817	pag. 128
BM6	8051272187182	pag. 75	EVO+3X55	8051272180824	pag. 128
BS6	8051272187205	pag. 75	EVO+3X9	8051272180831	pag. 128
BT01	8051272183634	pag. 56	EVO+6X100	8051272180848	pag. 129
C01	8051272183665	pag. 91	EVO+6X9	8051272180855	pag. 129
C4IO	8052015550898	pag. 12	EVO+9X9	8051272180862	pag. 129
CA48	8052015550294	pag. 58	EVO+A120	8051272180879	pag. 125
CB1	8051272180787	pag. 146	EVO+A240	8051272180886	pag. 125
CIM10X	8051272183689	pag. 92	EVO+A480	8051272180893	pag. 125
CIM15X	8051272183696	pag. 92	EVO+ASPLIT	8051272189711	pag. 125
CIM1X	8051272183702	pag. 92	EVO+AUXINMZ	8051272180909	pag. 126
CIM20X	8051272183719	pag. 92	EVO+B108Z	8051272180916	pag. 122
CIM30X	8051272183726	pag. 92	EVO+B1Z	8051272180923	pag. 122
CIM3X	8051272183733	pag. 92	EVO+B6Z	8051272180930	pag. 122
CIM5X	8051272183757	pag. 92	EVO+BSPLIT	8051272189971	pag. 125
CMI1	8051272183764	pag. 211	EVO+BSZ	8051272180947	pag. 122
CP12B	8051272189667	pag. 159	EVO+BVF	8051272180954	pag. 122
CP12W	8051272189650	pag. 159	EVO+C5P	8051272180961	pag. 126
CP21TB	8051272188714	pag. 159	EVO+ETH2	8051272180992	pag. 126
CP21TW	8051272188721	pag. 159	EVO+FCMONO	8051272189469	pag. 127
CR1	8051272187212	pag. 75	EVO+FCMULTI	8051272189476	pag. 127
CR3U	8052015550478	pag. 94	EVO+MASTER	8051272180794	pag. 121
CS10T	8051272182835	pag. 163	EVO+MS150	8051272181005	pag. 127
CS20T	8051272182859	pag. 163	EVO+PM5	8051272181012	pag. 126
CS40	8051272182866	pag. 163	EVO+PTTR	8051272181029	pag. 123
CS40T	8051272182873	pag. 163	EVO+PW24	8051272181036	pag. 125
CV101B	8051272189926	pag. 88	EVO+SLAVE	8051272181043	pag. 121
CV101W	8051272189919	pag. 88	EVO+SWT8X4	8051272181074	pag. 126
DA8	8051272189841	pag. 89	EVO+ZONAA	8051272181081	pag. 124
DADIRACK	8051272183832	pag. 95	EVO+ZONAAB	8051272181098	pag. 124
DRIVERLED	8051272183849	pag. 43	EVO100/1	8052015550676	pag. 108
DSP6	8051272188547	pag. 83	EVO100/2	8052015550683	pag. 108
E30S	8051272188059	pag. 31	EVO1000M/4	8051272188301	pag. 110

EVO1000M/6	8051272188318	pag. 110	GHOST930SUB	8052015551017	pag. 135
EVO250/1	8052015550652	pag. 108	GIADA10	8051272180022	pag. 137
EVO250/2	8052015550669	pag. 108	GIADA10.R	8051272182064	pag. 137
EVO500.B12Z	8051272180749	pag. 119	GIADA10B	8051272188691	pag. 137
EVO500.BVF	8051272180756	pag. 119	GIADA10F	8052015550164	pag. 137
EVO500.GM38	8051272180763	pag. 118	GIADA10F.R	8052015550300	pag. 137
EVO500.PTT	8051272180770	pag. 118	GIADA10T	8051272180039	pag. 137
EVO500/2	8051272180701	pag. 112	GIADA10TB	8051272188707	pag. 137
EVO500/4	8051272180718	pag. 112	GIADA10TF	8052015550171	pag. 137
EVO500/6	8051272180725	pag. 112	GIADA10TF.R	8052015550317	pag. 137
EVO500L	8051272180732	pag. 112	GIADA13AF	8051272188615	pag. 139
EVO500M/2	8051272188257	pag. 110	GIADA13AF.R	8051272188622	pag. 139
EVO500M/4	8051272188264	pag. 110	GIADA13F	8051272182071	pag. 139
EVO500M/6	8051272188271	pag. 110	GIADA13F.R	8051272182101	pag. 139
EVOM.2INPUT	8051272188288	pag. 110	GIADA13L	8051272182118	pag. 138
EVOM.6INPUT	8051272188295	pag. 110	GIADA13L.IP	8051272182125	pag. 138
FGA22	8051272188004	pag. 89	GIADA13L.R	8051272182132	pag. 138
FLORA10TB	8051272189292	pag. 160	GIADA13TF	8051272182149	pag. 139
FLORA10TW	8051272189308	pag. 160	GIADA13TF.R	8051272182156	pag. 139
FLORA13TB	8051272182903	pag. 160	GIADA13TL	8051272182163	pag. 138
FLORA13TW	8051272182910	pag. 160	GIADA13TL.IP	8051272182170	pag. 138
FLORA16SPB	8052015550614	pag. 160	GIADA13TL.R	8051272182187	pag. 138
FLORA16SPW	8052015550607	pag. 160	GIADA16	8051272182194	pag. 138
FLORA16TB	8051272187731	pag. 160	GIADA16.R	8051272182200	pag. 138
FLORA16TW	8051272187748	pag. 160	GIADA16AF	8051272187397	pag. 140
FREECONTROL	8051272187366	pag. 40	GIADA16AF.R	8051272188585	pag. 140
FREELIGHT.B	8051272189513	pag. 50	GIADA16F	8051272182217	pag. 140
FREELIGHT.S	8051272189520	pag. 50	GIADA16F.R	8051272182224	pag. 140
FREELIGHT.SABBIA	8051272189537	pag. 50	GIADA16HP	8051272182231	pag. 141
FREELIGHT.W	8051272189544	pag. 50	GIADA16HP.R	8051272182248	pag. 141
FREEMK3.B	8051272188158	pag. 50	GIADA16HPA	8051272182255	pag. 141
FREEMK3.S	8051272188172	pag. 50	GIADA16HPA.R	8051272182262	pag. 141
FREEMK3.SABBIA	8051272188400	pag. 50	GIADA16HPF	8051272188349	pag. 142
FREEMK3.W	8051272188165	pag. 50	GIADA16HPF.R	8051272188356	pag. 142
FREENETMK3.B	8051272188189	pag. 51	GIADA16HPFA	8051272188370	pag. 142
FREENETMK3.S	8051272188202	pag. 51	GIADA16HPFA.R	8051272188387	pag. 142
FREENETMK3.SABBIA	8051272188417	pag. 51	GIADA16TL	8051272182323	pag. 138
FREENETMK3.W	8051272188196	pag. 51	GIADA16TL.IP	8051272182330	pag. 138
FRESOURCEMK3.B	8051272188219	pag. 51	GIADA16TL.R	8051272182347	pag. 138
FRESOURCEMK3.W	8051272188226	pag. 51	GIADA16TF	8051272182309	pag. 140
GATEWAYKNX	8051272189872	pag. 43	GIADA16TF.R	8051272182316	pag. 140
GHOST930	8051272183993	pag. 135	GIADA20AF	8051272187373	pag. 142



GIADA20AF.R	8051272188592	pag. 142	iCONTROL4.0+	8051272182774	pag. 41
GIADA20F	8051272182354	pag. 140	iCONTROL4.0UPG	8051272184112	pag. 40
GIADA20F.R	8051272182361	pag. 140	iCONTROL4.1L	8051272187359	pag. 40
GIADA20HPF	8051272188936	pag. 142	iFREEMK3.55B	8051272189049	pag. 51
GIADA20HPF.R	8051272188943	pag. 142	iFREEMK3.55S	8051272189056	pag. 51
GIADA20HPFA	8051272188950	pag. 142	iFREEMK3.55W	8051272189063	pag. 51
GIADA20HPFA.R	8051272188967	pag. 142	iFREEMK3.70B	8051272189230	pag. 51
GIADA20SPF	8051272189575	pag. 143	iFREEMK3.70S	8051272189247	pag. 51
GIADA20SPF.R	8051272189582	pag. 143	iFREEMK3.70W	8051272189254	pag. 51
GIADA20TF	8051272182439	pag. 140	INCOMK2	8051272189391	pag. 86
GIADA20TF.R	8051272182446	pag. 140	INVISIBLE65	8051272184136	pag. 134
GIADA213F	8051272180138	pag. 139	INVISIBLE65T	8051272184143	pag. 134
GIADA213F.R	8051272182460	pag. 139	ISL2	8051272184167	pag. 89
GIADA213HP	8051272182477	pag. 141	K160A	8051272184198	pag. 196
GIADA213HP.IP	8051272189698	pag. 141	K160B	8051272184204	pag. 195
GIADA213HP.R	8051272182484	pag. 141	K160C	8051272184211	pag. 197
GIADA213HPF	8051272188974	pag. 141	K160E	8051272184228	pag. 196
GIADA213HPF.R	8051272188981	pag. 141	K160G	8051272184235	pag. 196
GIADA503B	8051272182514	pag. 136	K160R	8051272184242	pag. 196
GIADA503S	8051272182521	pag. 136	K160S	8051272184259	pag. 195
GIADA503W	8051272182538	pag. 136	K160V	8051272184266	pag. 197
GIADA506	8051272180015	pag. 136	K160W	8051272184273	pag. 197
GIADA506.R	8051272182552	pag. 136	K40A	8051272184280	pag. 196
GIADA506B	8051272189438	pag. 136	K40B	8051272184297	pag. 195
GIADA506F	8052015550140	pag. 136	K40C	8051272184303	pag. 197
GIADA506F.R	8052015550324	pag. 136	K40E	8051272184310	pag. 196
GIADA506T	8051272182569	pag. 136	K40G	8051272184327	pag. 196
GIADA506T.R	8051272182576	pag. 136	K40R	8051272184334	pag. 196
GIADA506TB	8051272189445	pag. 136	K40S	8051272184341	pag. 195
GIADA506TF	8052015550157	pag. 136	K40V	8051272184358	pag. 197
GIADA506TF.R	8052015550331	pag. 136	K40W	8051272184365	pag. 197
GREEN16T	8051272184013	pag. 189	K80A	8051272184372	pag. 196
GRM1	8051272188028	pag. 76	K80B	8051272184389	pag. 195
HDMI0.5	8051272184020	pag. 69	K80C	8051272184396	pag. 197
HDMI1	8051272184037	pag. 69	K80E	8051272184402	pag. 196
HDMI10	8051272184044	pag. 69	K80G	8051272184419	pag. 196
HDMI15	8051272184051	pag. 69	K80R	8051272184426	pag. 196
HDMI2	8051272184068	pag. 69	K80S	8051272184433	pag. 195
HDMI3	8051272184075	pag. 69	K80V	8051272184440	pag. 197
HDMI5	8051272184082	pag. 69	K80W	8051272184457	pag. 197
HDMISDI	8051272184099	pag. 67	KBOX	8051272189940	pag. 23
HDS	8051272184105	pag. 56	KEOPE.HP120	8051272184464	pag. 193

KEOPE.HP60	8051272184471	pag. 193	KM250C	8051272184778	pag. 197
KEOPE.HP60WIFI	8051272189858	pag. 21	KM250E	8051272184785	pag. 196
KEOPE.M250	8051272184488	pag. 193	KM250G	8051272184792	pag. 196
KEOPE.M250WIFI	8051272189865	pag. 21	KM250R	8051272184808	pag. 196
KEOPE.S160	8051272184495	pag. 192	KM250S	8051272184815	pag. 195
KEOPE.S40	8051272184501	pag. 192	KM250V	8051272184822	pag. 197
KEOPE.S40WIFI	8051272188097	pag. 19	KM250W	8051272184839	pag. 197
KEOPE.S80	8051272184518	pag. 192	KSB160A	8051272184846	pag. 196
KEOPE.S80WIFI	8051272188103	pag. 19	KSB160B	8051272184853	pag. 195
KEOPE.SOUNDB160	8051272184525	pag. 194	KSB160C	8051272184860	pag. 197
KEOPE.SOUNDB160WIFI	8051272188127	pag. 20	KSB160E	8051272184877	pag. 196
KEOPE.SOUNDB80	8051272184532	pag. 194	KSB160G	8051272184884	pag. 196
KEOPE.SOUNDB80WIFI	8051272188110	pag. 20	KSB160R	8051272184891	pag. 196
KEYGREEN16A	8052015550966	pag. 25	KSB160S	8051272184907	pag. 195
KEYROCK20A	8051272189780	pag. 24	KSB160V	8051272184914	pag. 197
KEYROUND16AF	8051272187717	pag. 22	KSB160W	8051272184921	pag. 197
KEYROUND16AF.R	8051272187724	pag. 22	KSB80A	8051272184938	pag. 196
KEYSOL	8051272184563	pag. 18	KSB80B	8051272184945	pag. 195
KEYSOL-15S	8051272189766	pag. 18	KSB80C	8051272184952	pag. 197
KEYSOL-DIN	8051272189759	pag. 28	KSB80E	8051272184969	pag. 196
KEYZEN315A	8052015550973	pag. 26	KSB80G	8051272184976	pag. 196
KEYZEN510A	8052015550980	pag. 26	KSB80R	8051272184983	pag. 196
KEYZEN730A	8052015550997	pag. 27	KSB80S	8051272184990	pag. 195
KHP120A	8051272184570	pag. 196	KSB80V	8051272185003	pag. 197
KHP120B	8051272184587	pag. 195	KSB80W	8051272185010	pag. 197
KHP120C	8051272184594	pag. 197	L1605	8051272187311	pag. 99
KHP120E	8051272184600	pag. 196	LARA10TB	8051272180107	pag. 158
KHP120G	8051272184617	pag. 196	LARA10TW	8051272182590	pag. 158
KHP120R	8051272184624	pag. 196	LARA9TB	8051272182606	pag. 158
KHP120S	8051272184631	pag. 195	LARA9TW	8051272180091	pag. 158
KHP120V	8051272184648	pag. 197	LINK	8051272185201	pag. 91
KHP120W	8051272184655	pag. 197	LINK4BP	8051272185225	pag. 91
KHP60A	8051272184662	pag. 196	LINKBP	8051272185232	pag. 91
KHP60B	8051272184679	pag. 195	M12X2BT	8051272188738	pag. 82
KHP60C	8051272184686	pag. 197	M16EFX	8051272189506	pag. 81
KHP60E	8051272184693	pag. 196	M5EFX	8051272189483	pag. 81
KHP60G	8051272184709	pag. 196	M8EFX	8051272189490	pag. 81
KHP60R	8051272184716	pag. 196	MA5060BTK	8051272188875	pag. 72
KHP60S	8051272184723	pag. 195	MA5120BTK	8051272188882	pag. 72
KHP60V	8051272184730	pag. 197	MA5240BTK	8051272188899	pag. 72
KHP60W	8051272184747	pag. 197	MARINE6	8051272183467	pag. 156
KM250A	8051272184754	pag. 196	MARINE6T	8051272183474	pag. 156
KM250B	8051272184761	pag. 195	MARINE7	8051272183481	pag. 156



MARINE7T	8051272183498	pag. 156	P2G	8051272185447	pag. 95
MATRIX6	8051272188769	pag. 29	P30S	8051272188035	pag. 30
MD208	8051272180541	pag. 83	P40SL	8051272180978	pag. 28
MICRO2.100	8051272185256	pag. 91	P4RC	8051272185454	pag. 94
MICRO2.200	8051272185263	pag. 91	P80S	8051272188042	pag. 30
MICRO2.50	8051272185270	pag. 91	PBT	8051272189995	pag. 36
MICRO220	8051272185287	pag. 91	PERLA13P	8051272185485	pag. 144
MICRO4.100	8051272185294	pag. 91	PERLA13P.R	8051272185492	pag. 144
MICRO4.200	8051272185300	pag. 91	PERLA13TP	8051272185508	pag. 144
MICRO4.50	8051272185317	pag. 91	PERLA13TP.R	8051272185515	pag. 144
MINI8B	8051272180169	pag. 158	PG58	8051272185522	pag. 87
MINI8B.IP	8051272189636	pag. 158	PH100M	8051272187922	pag. 164
MINI8W	8051272182897	pag. 158	PH15MK2	8051272182996	pag. 164
MINI8W.IP	8051272189643	pag. 158	PH208TPRO	8052015550348	pag. 165
MINISUB8AB	8052015550577	pag. 172	PH210TPRO	8051272189162	pag. 165
MINISUB8AW	8052015550560	pag. 172	PH212TPRO	8051272180503	pag. 165
MOD4i	8051272187038	pag. 43	PH30MK2	8051272183009	pag. 164
MONOLITE1B	8051272185324	pag. 206	PH50HIFI	8051272183016	pag. 164
MONOLITE1W	8051272185331	pag. 206	PH50M	8051272187915	pag. 164
MONOLITE2B	8051272185348	pag. 206	PHANTOM2	8051272185539	pag. 89
MONOLITE2W	8051272185355	pag. 206	PIEDERACK	8051272185546	pag. 95
MONOLITECENTERB	8051272185362	pag. 207	PL61	8051272185553	pag. 87
MONOLITECENTERW	8051272185379	pag. 207	PLANA2	8051272183023	pag. 157
MONOLITESATB	8051272185386	pag. 207	PLANA2B	8052015550638	pag. 157
MONOLITESATW	8051272185393	pag. 207	PLANA2T	8051272183030	pag. 157
MPR2	8051272186970	pag. 88	PLANA2TB	8052015550584	pag. 157
MS6060BT	8051272187991	pag. 74	PLS65	8051272186987	pag. 87
MS6120BT	8051272187199	pag. 74	PM2	8051272185560	pag. 58
MS6120BTK	8051272189735	pag. 74	PMA2120	8051272187236	pag. 78
MS6240BTK	8051272189742	pag. 74	PMA2240	8051272187243	pag. 78
MUSICO	8051272185416	pag. 42	PMA2500	8051272189032	pag. 78
MUSICOUPG		pag. 43	PNR1/2U	8051272185577	pag. 94
MY6	8051272185423	pag. 40	PNR1U	8051272185614	pag. 94
MZ126A	8051272183283	pag. 80	PNR1UA	8051272185621	pag. 94
MZ6120BTK	8051272188905	pag. 73	PNR2U	8051272185652	pag. 94
MZ6240BTK	8051272188912	pag. 73	PNR2UA	8051272185669	pag. 94
MZ6350BT	8051272187168	pag. 73	PNR3U	8051272185683	pag. 94
MZ6350BTK	8051272188929	pag. 73	PNR4U	8051272185706	pag. 94
MZ6500BT	8051272187175	pag. 73	PNRMT16	8051272185720	pag. 94
MZ6500BTK	8052015550003	pag. 73	POWER10A	8051272180510	pag. 177
OPERA	8052015550911	pag. 154	POWER12A	8051272180527	pag. 177
P1G	8051272185430	pag. 95	PRD1	8051272189988	pag. 89
P24D	8051272189094	pag. 94	PS10	8051272182927	pag. 162

PS1000	8051272189018	pag. 79	RG16FB	8052015550508	pag. 140
PS20BIDI	8051272182934	pag. 162	RG58U50.1	8052015550935	pag. 96
PS3000	8051272189025	pag. 79	ROCK20T	8051272188554	pag. 189
PS7	8051272182941	pag. 58	RONDELLERACK	8051272186277	pag. 95
PSA300MK2	8051272189889	pag. 78	ROUND10EN	8051272180589	pag. 146
PSA4300	8051272180008	pag. 79	ROUND12	8051272180152	pag. 145
PSA4500	8051272188530	pag. 79	ROUND12.R	8051272183047	pag. 145
PSA500MK2	8051272189896	pag. 78	ROUND12B	8051272188141	pag. 145
PSA6500	8051272188523	pag. 79	ROUND12T	8051272183054	pag. 145
PSA8500	8051272188516	pag. 79	ROUND12T.R	8051272183061	pag. 145
PSK	8051272182989	pag. 94	ROUND12TB	8051272187014	pag. 145
PSL20BIDI	8051272189346	pag. 162	ROUND13EN	8051272180565	pag. 146
QTOWER1	8051272185980	pag. 198	ROUND13F	8051272187069	pag. 149
QTOWER2	8051272185997	pag. 198	ROUND13F.R	8051272188424	pag. 149
QTOWER2C	8051272186000	pag. 198	ROUND13L	8051272180046	pag. 148
QTOWER4	8051272181159	pag. 200	ROUND13L.R	8051272183092	pag. 148
QTOWER4C	8051272186017	pag. 200	ROUND13TF	8051272187021	pag. 149
QTOWER4PRO	8051272186024	pag. 200	ROUND13TF.R	8051272187700	pag. 149
QTOWER4PROA	8051272186031	pag. 200	ROUND13TL	8051272180053	pag. 148
QTOWER6PRO	8051272186048	pag. 202	ROUND13TL.R	8051272183115	pag. 148
QTOWER6PROA	8051272186055	pag. 202	ROUND16AB	8051272189384	pag. 147
QTOWER8PRO	8051272186062	pag. 202	ROUND16AF	8051272187380	pag. 150
QTOWER8PROA	8051272186079	pag. 202	ROUND16AF.R	8051272188653	pag. 150
QTOWERBP	8051272188745	pag. 204	ROUND16EN	8051272180572	pag. 147
QTOWERMonitor	8051272186086	pag. 202	ROUND16F	8051272180084	pag. 150
QTOWERSO	8051272186093	pag. 204	ROUND16F.R	8051272183146	pag. 150
RACK12U	8052015550355	pag. 93	ROUND16L	8051272180060	pag. 148
RACK12UC	8052015550393	pag. 93	ROUND16L.IP	8051272189681	pag. 148
RACK12UEVA	8052015550430	pag. 130	ROUND16L.R	8051272183160	pag. 148
RACK22U	8052015550362	pag. 93	ROUND16TF	8051272183177	pag. 150
RACK22UC	8052015550409	pag. 93	ROUND16TF.R	8051272183184	pag. 150
RACK22UEVA	8052015550447	pag. 130	ROUND16TL	8051272180077	pag. 148
RACK32U	8052015550379	pag. 93	ROUND16TL.R	8051272183207	pag. 148
RACK32UC	8052015550416	pag. 93	ROUND17TF	8051272180145	pag. 150
RACK32UEVA	8052015550454	pag. 130	ROUND17TF.R	8051272188608	pag. 150
RACK42U	8052015550386	pag. 93	ROUND20AF	8051272188660	pag. 151
RACK42UC	8052015550423	pag. 93	ROUND20AF.R	8051272188677	pag. 151
RACK42UEVA	8052015550461	pag. 130	ROUND20F	8051272181111	pag. 151
RG10FB	8052015551079	pag. 137	ROUND20F.R	8051272183238	pag. 151
RG13FB	8052015550706	pag. 139	ROUND20HPF	8051272189551	pag. 152
RG506FB	8052015551086	pag. 136	ROUND20HPF.R	8051272189568	pag. 152



ROUND20SPF	8051272189599	pag. 153	SR2FC	8051272181241	pag. 183
ROUND20SPF.R	8051272189605	pag. 153	SR2FM	8051272181258	pag. 183
ROUND20TF	8051272181128	pag. 151	SR3	8051272181265	pag. 181
ROUND20TF.R	8051272188431	pag. 151	SR30	8052015550287	pag. 182
ROUND5T	8051272183306	pag. 145	SR3FC	8051272181272	pag. 183
ROUND5TB	8051272187007	pag. 145	SR3FM	8051272181289	pag. 183
ROUND6T	8051272183313	pag. 145	SR3PLUS	8051272181296	pag. 181
ROUND7F	8051272181104	pag. 149	SR500	8051272181302	pag. 95
ROUND7F.R	8051272183337	pag. 149	ST212	8051272189070	pag. 165
ROUND7TF	8051272183344	pag. 149	ST3	8051272186406	pag. 90
ROUND7TF.R	8051272183351	pag. 149	ST5	8051272186963	pag. 90
RR13F	8052015550768	pag. 149	STANDGFC	8051272180282	pag. 90
RR13FB	8052015550492	pag. 149	STANDGFR	8052015551109	pag. 90
RR16FB	8052015550492	pag. 150	STANDSK	8051272186413	pag. 90
RR7FB	8052015551024	pag. 149	STANDWM	8051272180275	pag. 180
RUOTEG	8051272186284	pag. 95	SUB10AB	8051272186420	pag. 173
SC100	8051272186321	pag. 75	SUB10AW	8051272186437	pag. 173
SC2	8051272186338	pag. 181	SUB12AB	8051272187663	pag. 173
SC930	8051272186345	pag. 135	SUB12AW	8051272187670	pag. 173
SCWM12	8051272183290	pag. 180	SUB15A	8051272180305	pag. 178
SCWM8	8051272188837	pag. 180	SUB6AW	8051272186451	pag. 172
SDIHDMI	8051272186352	pag. 67	SUB8AB	8051272187649	pag. 173
SIR1	8051272186369	pag. 59	SUB8ALB	8052015550546	pag. 172
SM3	8051272186383	pag. 89	SUB8APB	8052015550539	pag. 172
SMARTQUBEB	8051272181166	pag. 173	SUB8APW	8052015550553	pag. 172
SMARTQUBEW	8051272186390	pag. 173	SUB8AW	8051272187656	pag. 173
SOUND12	8051272180251	pag. 176	SUBGIADA20F	8052015550249	pag. 170
SOUND12A	8051272180268	pag. 176	SUBGIADA20F.R	8052015550256	pag. 170
SOUND8	8051272180237	pag. 176	SUBGIADA20FA	8052015550263	pag. 170
SOUND8A	8051272180244	pag. 176	SUBGIADA20FA.R	8052015550270	pag. 170
SQR13	8051272187076	pag. 182	SUBGIADA20SPF	8051272183399	pag. 171
SQR20	8051272187083	pag. 183	SUBGIADA20SPF.R	8051272188851	pag. 171
SR1	8051272181173	pag. 181	SUBGIADA20SPFA	8052015550188	pag. 171
SR10	8051272181180	pag. 180	SUBGIADA20SPFA.R	8052015550195	pag. 171
SR10ENX	8051272181197	pag. 180	SUBINVISIBLE50	8052015550775	pag. 134
SR10ENXB	8051272189261	pag. 180	SUBINVISIBLE50T	8052015551000	pag. 134
SR13	8051272181203	pag. 182	SUBROUND20F	8051272183368	pag. 170
SR16	8051272181210	pag. 182	SUBROUND20F.R	8051272183375	pag. 170
SR1S	8051272181227	pag. 181	SUBROUND20FA	8051272187090	pag. 170
SR2	8051272181234	pag. 181	SUBROUND20FA.R	8051272188844	pag. 170
SR20	8051272189957	pag. 182	SUBROUND20SPF	8052015550201	pag. 171

SUBROUND20SPF.R	8052015550218	pag. 171	VREC50	8051272186765	pag. 67
SUBROUND20SPFA	8052015550225	pag. 171	VSP14HA	8052015550096	pag. 66
SUBROUND20SPFA.R	8052015550232	pag. 171	VSP18H	8051272180602	pag. 66
SUCS	8051272188752	pag. 90	VSW41H	8051272180619	pag. 66
SUPERZEN	8051272189902	pag. 187	VSW41HSMK2	8052015551062	pag. 67
TCIR5B	8051272180336	pag. 56	WB1	8051272189339	pag. 195
TCIR5W	8051272180329	pag. 56	WB2	8051272189612	pag. 195
TELEMACO	8051272189964	pag. 8	WB3	8051272189629	pag. 195
TR10	8051272186499	pag. 92	WSB2603	8052015550621	pag. 97
TR15	8051272186505	pag. 92	WSH1603	8051272186802	pag. 97
TR30	8051272186529	pag. 92	WSH2603	8051272187298	pag. 98
TR5	8051272188448	pag. 92	WSHL2603	8051272187304	pag. 98
TR50	8051272188578	pag. 92	WSL1605	8051272186826	pag. 97
TR6	8051272186543	pag. 92	WSL2605	8051272186833	pag. 98
TVE	8052015550904	pag. 13	WSR4	8052015550928	pag. 96
TVM	8051272186550	pag. 31	WTH1603	8051272186840	pag. 99
TVS	8051272186567	pag. 31	WTL1605	8051272186864	pag. 99
U891RB	8051272186581	pag. 87	ZEN315	8051272186871	pag. 185
U891RW	8051272186598	pag. 87	ZEN315L	8051272186888	pag. 188
UNIVERSALGW	8051272186604	pag. 58	ZEN315T	8051272188455	pag. 185
VAEXT2	8051272188134	pag. 68	ZEN510	8051272186895	pag. 185
VCD2A	8051272186611	pag. 68	ZEN510T	8051272188479	pag. 185
VDAC	8052015550089	pag. 68	ZEN730	8051272186901	pag. 186
VE150H	8052015550102	pag. 65	ZEN730L	8051272186918	pag. 188
VE150IP	8052015550119	pag. 65	ZEN730T	8051272188462	pag. 186
VE300A	8052015550133	pag. 88	ZEN780	8051272186925	pag. 186
VE50IPH	8051272188868	pag. 65	ZEN780A	8051272188493	pag. 186
VE70R	8051272180657	pag. 63	ZEN930	8051272186932	pag. 187
VEOF4K	8052015551178	pag. 88	ZEN930T	8051272188486	pag. 187
VG10.100	8051272182453	pag. 59	ZEN980	8051272186949	pag. 187
VG10.200	8051272182545	pag. 59	ZEN980A	8051272188509	pag. 187
VG10.50	8051272182583	pag. 59			
VHRPT	8051272186703	pag. 68			
VITIRACK	8051272186710	pag. 95			
VM44H100E	8051272181135	pag. 64			
VM44HS	8051272186734	pag. 62			
VM66H70+	8051272180671	pag. 64			
VM88H150E	8052015551093	pag. 64			
VM88H70E	8051272180640	pag. 63			
VOICE	8051272189209	pag. 84			
VPS70A	8051272180626	pag. 67			

Legenda applicazioni Application Legend



Negozi
Shops



Uffici
Offices



SPA e centri benessere
SPA



Palestre
Gyms



Giardini, terrazze, parchi e piscine
Gardens, terraces, parks and swimming pools



Poliambulatori
Polyclinics



Sale conferenze
Conference rooms



Centri sportivi
Sport centers



Hospitality
Hospitality

WiFi

Dispositivi multimediali WiFi con player Keysol integrato, controllabili da APP Vivaldi
WiFi multimedia devices with integrated Keysol player, control from Vivaldi App



Idoneo all'utilizzo all'esterno
Suitable for outdoor use



Abitazioni
Homes



Luoghi di culto
Places of worship



Imbarcazioni
Boats



Terziario, Public address, centri commerciali
Tertiary, Public address, shopping centers



Magazzini e grandi spazi con soffitti alti
Warehouses and large spaces with high ceilings



Ristoranti, caffetterie, mense, pasticcerie
Restaurants, cafes, canteens, pastry shops



Home Cinema
Home Cinema



Locali di intrattenimento, pub, disco
Entertainment venues, pubs, disco



Cabinet in plastica ignifuga
Fireproof plastic cabinet

EN54

Diffusori acustici per l'evacuazione vocale secondo norme CEI EN 60849 UNI7240-19 EN54-24 ideali per parlato e diffusione sonora
Loudspeakers for vocal evacuation according to CEI EN 60849 UNIT7240-19 EN54-24 ideal for speech and Public address

SEGUICI ANCHE SU
FOLLOW US ALSO ON

#vivaldiunitedgroup

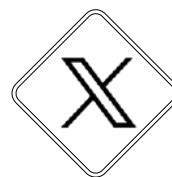
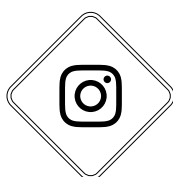

Vivaldi srl
Via E. Fermi, 8
Via T. A. Edison, 2
30020 Noventa di Piave (VE)

invio merci
Via T. A. Edison, 4
30020 Noventa di Piave (VE)

+39 0421 307825
info@vivaldigroup.it
vivaldigroup.it

Vivaldi International
+39 0421 307825 ext 0
vivaldi@vivaldigroup.it

Vivaldi srl
divisione di Vivaldi United Group

Noventa di Piave (VENEZIA) - Italia

VIVALDI